

INDOOR AIR TREATMENT SOLUTIONS

PORTABLE AIR PURIFIERS



FILTRATION AND DISINFECTION UNITS



GERMICIDAL CHAMBERS



HEAT RECOVERY UNITS



MONITORING AND CONTROL



CLEANING, AIR DISINFECTION AND ENERGY SAVING WITH HEAT RECOVERY



SODECA's business is centred on providing efficient ventilation and indoor air quality solutions.

Indoor Air Quality (IAQ) is the quality of the air that we breathe indoors and is governed by many conditions that directly affect our health and well-being. Different factors exist inside buildings that affect the air that we take into our lungs. The indoor humidity and temperature, along with different contaminants that are present internally, are added to harmful elements entering from the outside. Poor natural ventilation coupled with inadequate installation increases the risk of inhaling viruses and bacteria as well as other contaminants that affect our IAQ.

For this reason, SODECA offers ventilation and air treatment solutions that meet the most stringent quality standards and in accordance with current legislation, to ensure the air that we breathe is of the best quality and is safe for our health as well as our environment.

This catalogue contains just a few of all the options we offer. Please contact us and we will give you the best advice from our experienced and knowledgeable staff.

HIGH THERMAL EFFICIENCY AND INDOOR AIR QUALITY

SODECA continuously improves their building ventilation solutions in order to meet the need to breathing healthy air with comfort and energy savings.

Commercial premises, offices, hospitality venues and communal spaces can now have **the most efficient heat recovery units**. High efficiency heat recovery units offer better indoor air quality (IAQ) and ultimately, health and well-being, as well as important energy savings.



THE IMPORTANCE OF **BREATHING HEALTHY AIR**

Air contamination can have significant consequences on people's health and productivity. However, the solutions we implement in indoor spaces must be chosen correctly.

Ideal indoor air quality is not only a source of wellbeing, it is also an opportunity to optimise resources. People are increasingly spending more time indoors. A building with healthy air equates to well-being as well as efficiency. Breathing healthy air has never been so important as it is today. Investing in high efficiency solutions that transform indoor air into healthy air guarantees peace of mind.



ENERGY EFFICIENCY INVESTMENT IN SUSTAINABILITY AND HEALTH

Renewing indoor air and saving energy. The aim of Directive 2010/31/EU is to create buildings that are sustainable as well as environmentally friendly.

Heat recovery units are ventilation systems that renew and condition inside air, while saving energy in the process. These units constitute the best solution to achieve good quality indoor air efficiently. An essential step towards a more sustainable world with healthier air.



NEW WEB APP

Use our new web app to easily and quickly find the portable air purifier that is most suitable for your home or business.

QUICK PURIFIER SEARCH TOOL

- 01. Complete a simple form
- 02. Analyse the results
- 03. Obtain a product proposal

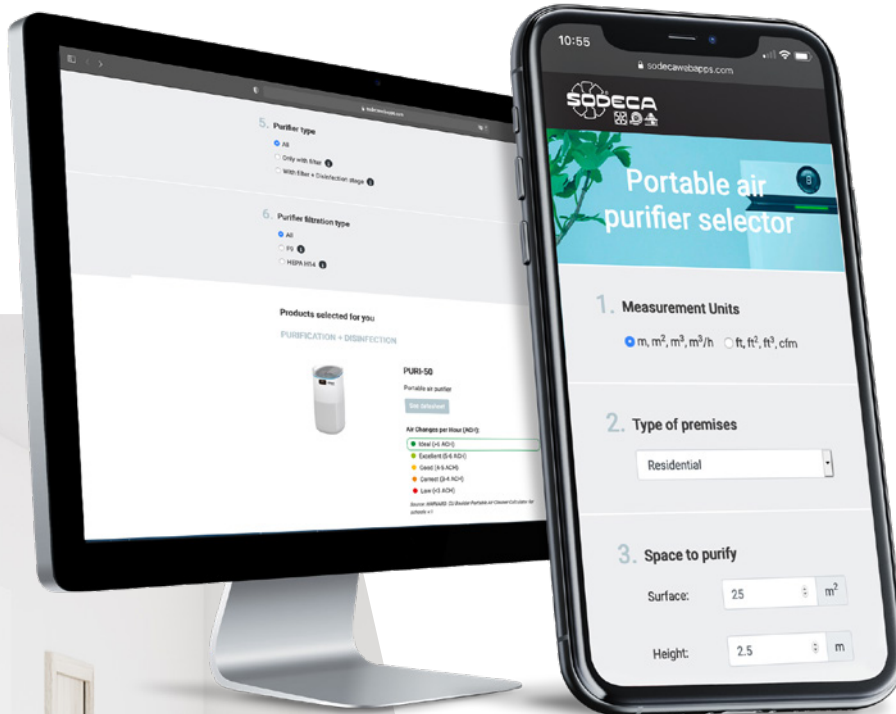

APPLICATIONS



- Schools and training centres
- Universities



- Pharmacies
- Medical and dental centres
- Nursing homes



- Offices
- Shops

QUICK SELECTION TABLE



PURI

Model	m ² *
50	45-50



SV/FILTER-CG

F7 + F9

Model	m ² *
200	20-50
250	50-100
315	50-140
350	100-140



CJK/FILTER/EC

F7 + FCA + F9

Model	m ² *
220	35-65
250	45-75
310	50-80
400	175-200
500	255-285

F7 + FCA + HEPA H14

Model	m ² *
310	40-70
400	140-170
500	215-245



UPH/EC

F9

Model	m ² *
220	35-65
250	45-75
310	50-80
400	175-200

HEPA H14

Model	m ² *
310	40-70
400	140-170



UPM/EC

G2 + F9 + FCA

Model	m ² *
310	50-80
310/H	100-130
400	175-200

G2 + FCA + HEPA H14

Model	m ² *
310	40-70
310/H	75-100
400	140-170



UPA

F7 + F9

Model	m ² *
1500	200-350
3000	300-450
4500	450-900
6000	900-1100

F7 + HEPA H14

Model	m ² *
1500	200-350
3000	300-450
4500	450-900
6000	900-1100



- Bars and cafes
- Restaurants
- Hotels
- Gyms, spas



- Hotels



- Manufacturing industry



- General warehouses
- Logistic warehouses
- Airport waiting rooms
- Hospital waiting rooms



- 4.0 technology industry



- Medical industry
- Pharmaceutical industry
- Data centres
- Food industry
- Laboratories



- Automotive industry

FILTRATION STAGES AND THEIR EFFICIENCY

To maintain a good quality of indoor air, it is necessary to filter out particles that pollute the air, particularly the smallest particles, which are the most dangerous to health.

Air pollution in areas of high occupancy and mobility are contaminated by small particles and by gases from combustion engines. In addition, the presence of spores, mites and other bacteria or viruses can also have an adverse effect on health if they are not eliminated from the air that we breathe.

For optimum installation, the filters to be used are those classified as efficiency ePM1 ePM2.5 and Epm10 according to ISO 16890.

EPM1 final filter stages

For applications in buildings such as schools, commercial installations or offices, the use of fine filters, of at least type ePM1, is recommended. These filter types are efficient at retaining particles between 0.3 to 1 micron in diameter and are more economically maintainable.

HEPA final filter stages

HEPA filters have the highest efficiency of all and are widely used in the medical industry for applications in surgical areas, to prevent the spread of bacteria and viruses. Their use in commercial applications must be accompanied by strict maintenance and replacement protocols to avoid hygiene problems due to the high concentration of microorganisms.

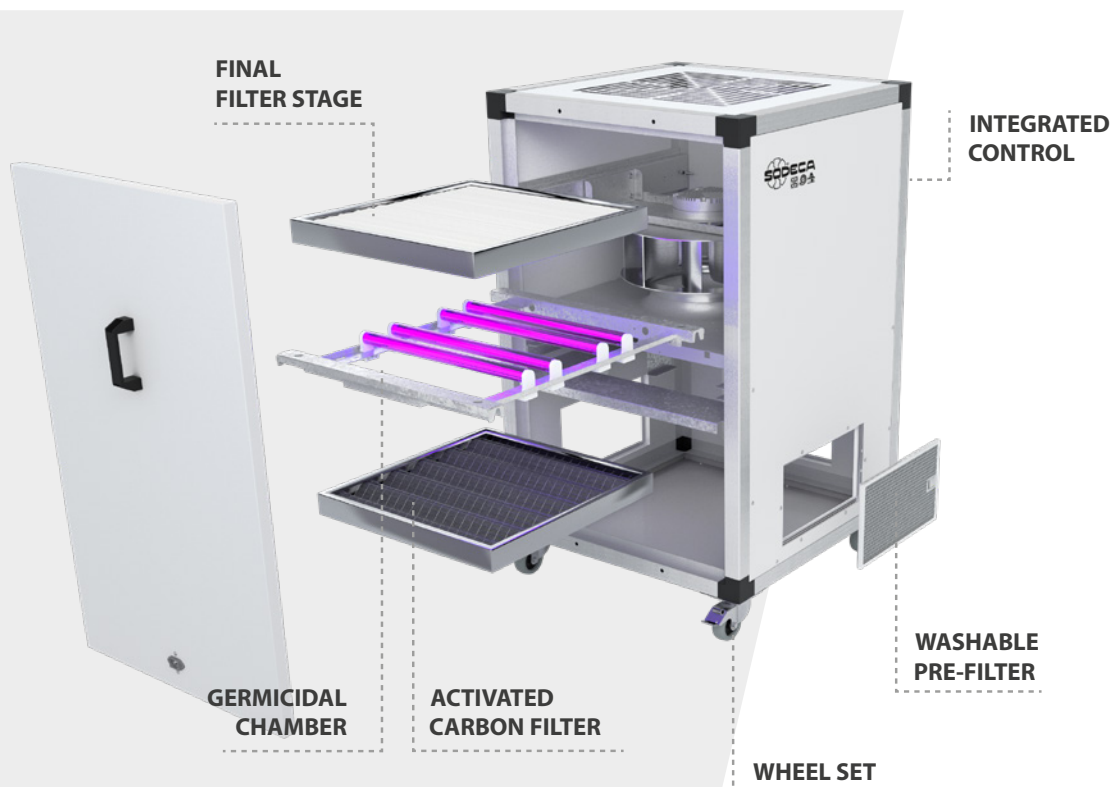

FILTRATION EFFICIENCY



Prefilters
F7

Lint and large particles

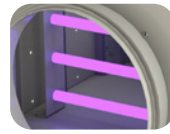

UVC germicidal chamber

Viruses and bacteria



Final filters
F9 or Hepa

Spores, mites and fungi



Active carbon filter

Odours and organic compounds

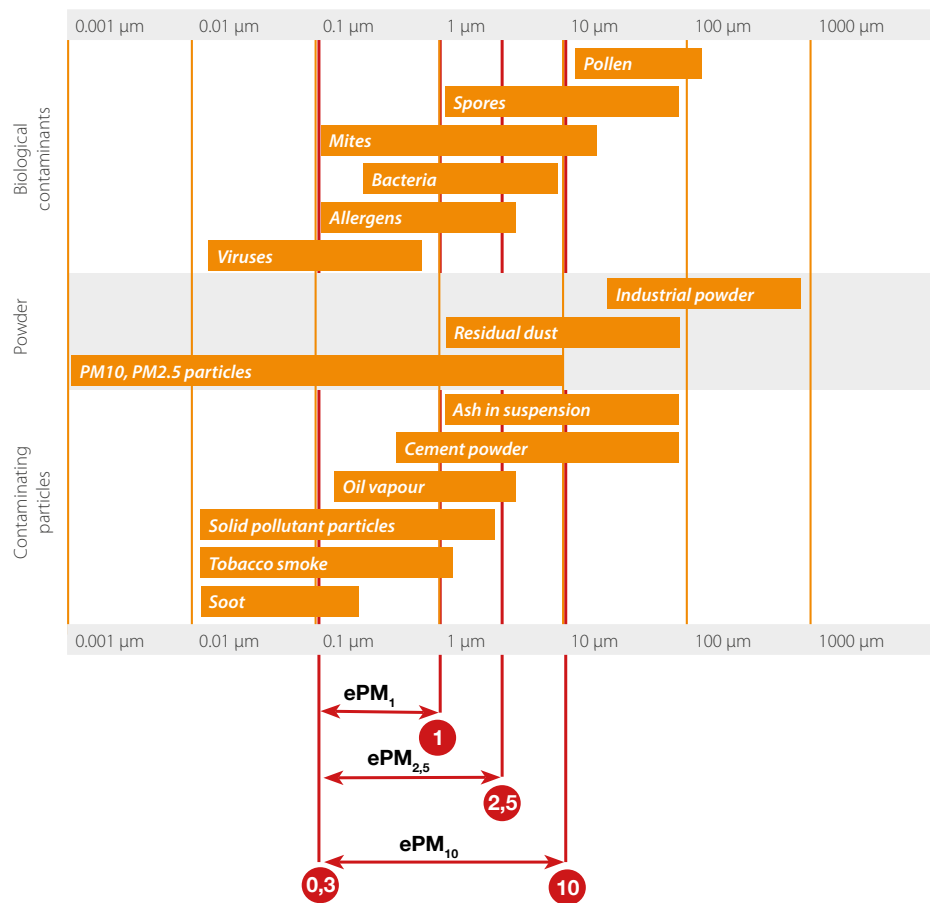

Filtration efficiency

It is common to refer to the efficiency of filters as being in accordance with EN 779 although the current standard is ISO 16890. Both standards deal with the efficiency of coarse and fine dust filters used in ventilation. The EN standard is based on 0.4 micron particles, the ISO 16890 standard defines the efficiency for various particle size fractions measured at intervals starting from 0.3 microns. For HEPA filters, the efficiency is measured in accordance with standard EN 1822.

Filters	EN 779 Em	EN 1822	ISO 16890			
			ISO ePM ₁	ISO ePM _{2,5}	ISO ePM ₁₀	ISO COARSE
G4	90%	-	-	-	-	>90%
F7	90%	-	>50%	>65-95%	>85%	-
F9	95%	-	>80%	>95%	>95%	-
HEPA H14	-	>99,995%	-	-	-	-

CERTIFICATIONS AND STANDARD



The solutions provided by SODECA for purifying and disinfecting indoor air are compliant with standard EN 14476 and are certified by external laboratories as well as by other field methods following standardised procedures.

The efficacy of air purifying technology has been proven in a laboratory certified by ENAC and APPLUS+ in accordance with standard EN 14476 for the evaluation of virucidal activity in the medical area for antiseptic and disinfectant tests.

The tests conducted in this laboratory have demonstrated an antiviral activity of 100% for inoculated Mengovirus (a microorganism of the same family as SARS-CoV-2, which causes COVID-19), also obtaining a very important reduction of aerobic bacteria and environmental fungi.

The cultured virus strain has been inoculated into the air in a controlled manner and the pertinent tests have been conducted in accordance with standard EN 14476, analysing the air at the inlet and outlet of the purification unit with germicidal chamber.



RESULTS CERTIFIED IN ACCORDANCE WITH STANDARD EN 14476

Equipment	Antiviral activity	Time	Reduction of aerobic bacteria	Reduction of environmental fungi	Presence of ozone
UPM	100%	15'	95%	81%	NO
UPA	100%	10'	100%	100%	NO
DISINFECTION BOX	100%	5'	96%	90%	NO
UPT	100% ⁽¹⁾	40'	98,15%	96,67%	NO

(1) In 10' of treatment

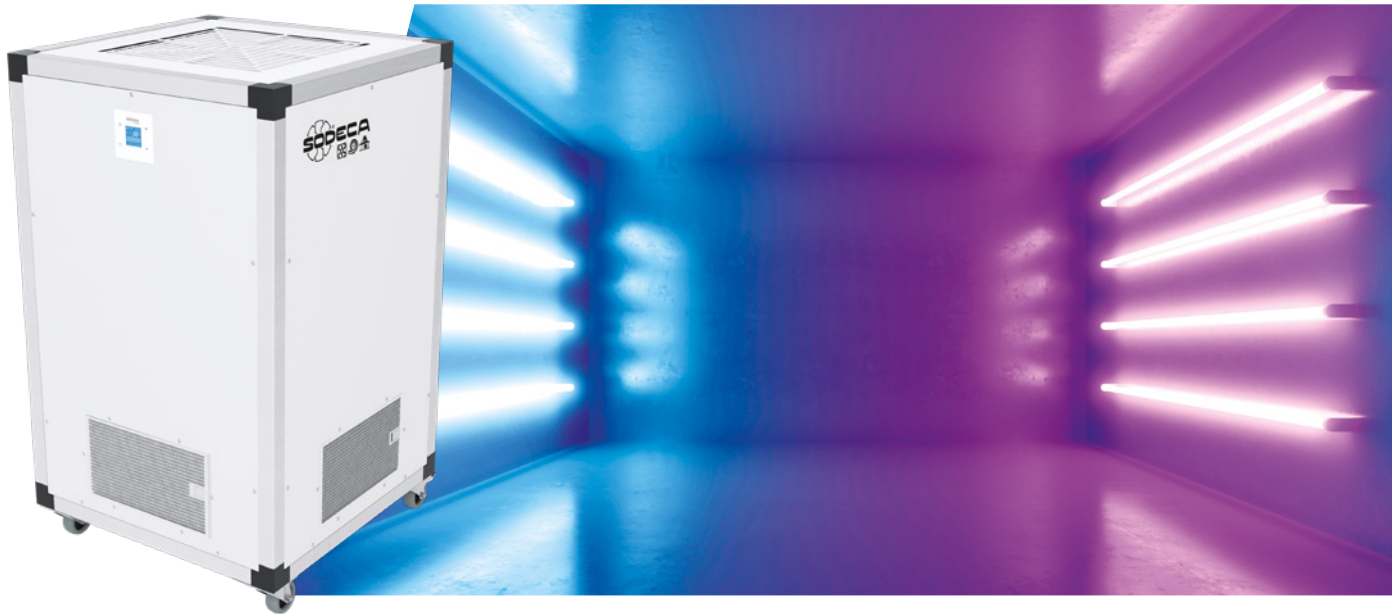

ACTUAL STUDY OF THE EFFECTIVENESS OF THE GERMICIDAL CHAMBER

SODECA, in collaboration with the **Fluid Mechanics Department CATMech/Labson of Universitat Politècnica de Catalunya (UPC)**, has conducted an actual study to evaluate the effectiveness of a purifier with a germicidal chamber and HEPA H14 filters on bacteria and fungi inside a classroom.



For two months we have sampled 390 petri dishes collecting environmental bacteria and fungi. In this case study we have concluded that in a 30m² room where a purifier without a germicidal chamber is being operated, only a reduction of 58% of bacteria and 78% of fungi was observed. On the other hand, operating the same purifier with a germicidal chamber eliminates up to 95% of bacteria and fungi in less than two hours.

Bacteria measurements with and without a germicidal chamber

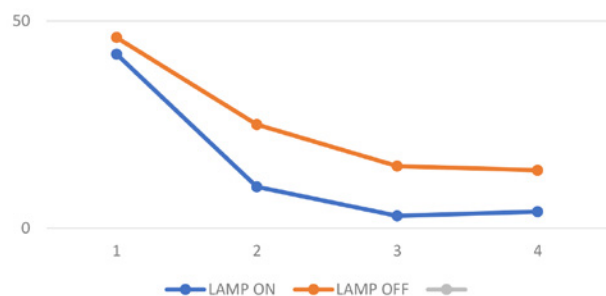

Fungi measurements with and without a germicidal chamber

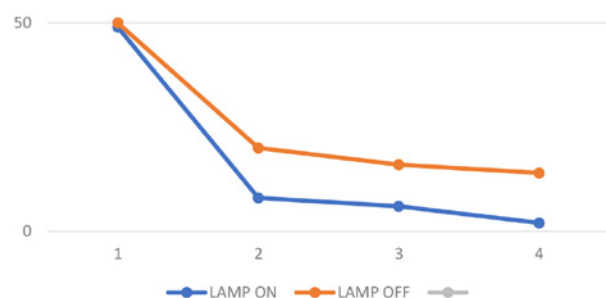

TECHNOLOGIES USED FOR IMPROVING INDOOR AIR QUALITY

The air that we breathe will be healthier when the most appropriate technology is used. More than ever these days, our well-being and health is dependent on the environmental conditions of the buildings and premises that we spend most of our time in. Opening windows is no longer a guarantee that our health is being protected and, more often than not, leads to discomfort. Knowing that we are guaranteed to breathe clean air gives us peace of mind. Also, modifying our buildings using equipment that complies with environmental and energy regulations is an investment that produces cost savings and improves quality of life.

Air purification systems supplement ventilation to achieve air that is clean and pure inside a building. This happens by recirculating the air, reducing the supply of external air and achieving a healthier working environment with less pollutants and particles that are harmful to health, all while providing energy savings.



Each environment requires an appropriate technical solution for improving the indoor air quality based on the pollutant that is affecting it. Our technologies offer solutions to all problems related with indoor air quality:

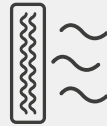

Filter solutions

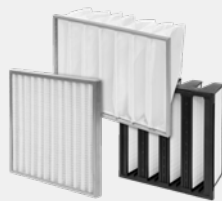

Solutions that use HEPA filters, F9 and active carbon filters **for problems caused by solid particles and odours.**



Ultraviolet Light



Solutions that use UVC ultraviolet light **to inactivate viruses, bacteria and germs.**

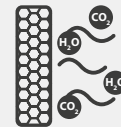

Photocatalysis

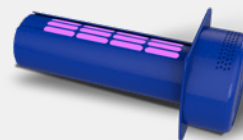

Solutions that use photocatalysis **for spaces that require a highly efficient disinfection.**



Electrostatic Filter



Solutions that use electrostatic **filters to eliminate grease and odours.**



Activated carbon filters



Solutions with activated carbon filters, **for the elimination of unwanted contaminants and to trap odours, gases and allergens.**

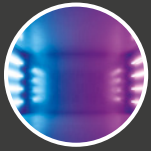

UVC
germicidal
chamber

GERMICIDAL CHAMBERS WITH UV LIGHT ENDORSED BY ASHRAE AND BY IUVA

Germicidal chambers with UVC ultraviolet light are used together with other appropriate technologies to ensure that any pathogen that has not been captured by any preceding method such as filtration, is finally inactivated using UVC technology.

According to ASHRAE, irradiation uses UVC shortwave ultraviolet energy to inactivate viral, bacterial, and fungal organisms so that they cannot replicate and cause disease. UVC energy damages deoxyribonucleic acid (DNA) in a wide range of microorganisms, making them harmless. The standard UVC lamps in commercial systems are lowpressure mercury vapour lamps that primarily emit a virtually optimal UVC of 256nm to achieve a germicidal process on the through-air.



As concern about indoor air quality grows, UVC is increasingly being used to disrupt the transmission of pathogenic organisms such as mycobacterium tuberculosis (TB), influenza and mold viruses. This is done by applying UVC to improve indoor air quality (IAQ) and consequently, improve health, comfort, and productivity.

INCREASE IN **PRODUCTIVITY AND CONCENTRATION**

In a professional workplace, increasingly high occupation rates means that regular ventilation is not enough to achieve good indoor air quality. It is necessary to complement ventilation with air purifiers to obtain an optimal, healthy environment of clean, pure air.

Studies show that **the better the air quality, the better our performance**, increasing the efficiency of our daily actions based on the improvement in blood oxygenation.



The International Ultraviolet Association (IUVA) endorses that **UVC disinfection technologies play an important role in the multiple processes used to reduce the transmission of the virus** that causes COVID-19, based on disinfection data and empirical evidence. UVC is a well-known disinfectant for air, water and surfaces which can help reduce the risk of COVID-19 contagion when applied correctly.

UVC DOSE

Some examples of effective dosage for virus and bacteria inactivation

For more information you can consult:
www.iuva.org

** Table according to IUVA (International UltraViolet Association)*

TYPE	NAME	INACTIVATION DOSE (mJ/cm2)		REFERENCE
		1st (90%)	2nd (99%)	
BACTERIA	Legionella pneumophila	3,1	5,0	Wilson et al. 1992
	Salmonella enteritidis	5,0	7,0	Tosa and Hirata 1998
	Salmonella typhimurium	3,0	11,5	Maya et al. 2003
	Shigella dysenteriae	0,5	2,0	Wilson et al. 1992
	Shigella sonnei	3,2	4,9	Chang et al. 1985
	Vibrio cholerae	0,8	1,4	Wilson et al. 1992
	Citrobacter diversus	5,0	7,0	Giese and Darby 2000
	Mycobacterium tuberculosis	2,2	4,3	Collins 1971
PROTOZOA	Listeria monocytogenes	2,2	3,0	Collins 1971
	Cryptosporidium parvum	<2	<2	Clancy et al. 2004
	Giardia lamblia	<10	~10	Campbell et al. 2002
	Giardia muris	<2	<2	Mofidi et al. 2002
VIRUS	Encephalitozoon intestinalis, microsporidia	3,0	5,0	Marshall et al. 2003
	Adenovirus 40	55,0	105,0	Thurston-Enriquez et al. 2003
	Echovirus II	7,0	14,0	Gerba et al. 2002
	Hepatitis A	5,1	13,7	Wilson et al. 1992
	Poliovirus Tipo 1	5,7	11,0	Wilson et al. 1992
	Rotavirus SA11	8,0	15,0	Sommer et al. 1989

Based on evidence that UVC light has been used for 40 years to remove viruses and bacteria from wastewater and pharmaceuticals products, including Coronaviruses. Some viruses or bacteria may be more susceptible to UVC disinfection than others, but they can all be inactivated with appropriate doses.

UVC light is used in hospital, medical and scientific techniques, always making specific reference to UV Germicide (UVC of 200-280 nm) and that under controlled laboratory conditions has scientifically demonstrated that it inactivates two Coronaviruses close to SARS-CoV-2, such as SARS-CoV-1 and MERS-CoV.

IMPROVE HEALTH

Most people spend 70% - 90% of their time being stuck inside, be it at work or at home. During this time we breathe an average of 20 to 25 Kg of air, the quality of which is vitally important to our body. Breathing clean air **reduces respiratory and fatigue problems.**

Good air quality improves health and improves mental and physical well-being, as well as increasing life expectancy.



HEAT RECOVERY UNITS

SODECA heat recovery units are designed to ensure the highest quality of air inside buildings. All models offer different filtration possibilities depending on the needs required by the space to be treated.

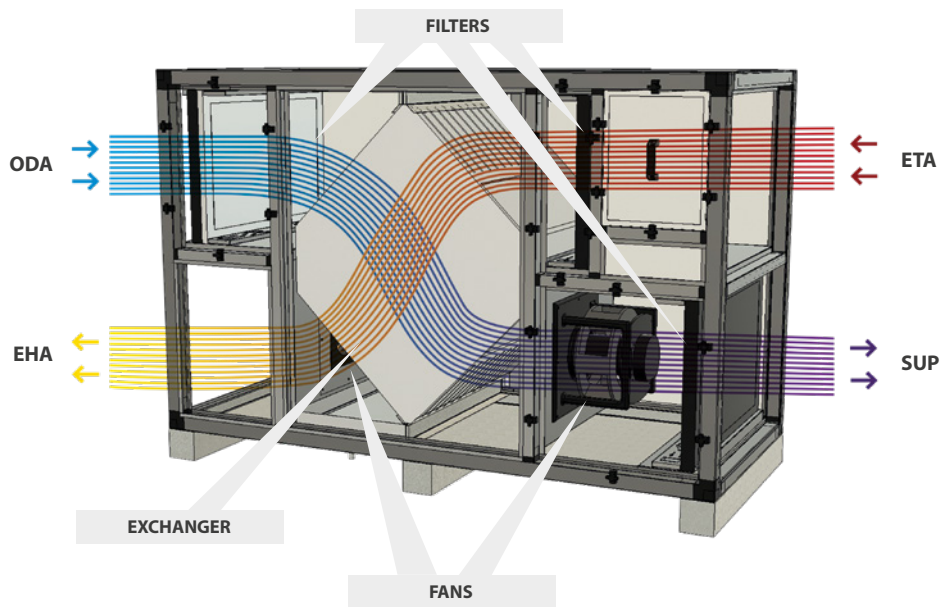

ODA: Fresh outdoor air / **EHA:** Exit of exhaust air / **ETA:** Air extracted from premises / **SUP:** Air supplied into the premises

EC TECHNOLOGY, GUARANTEED OF PEACE OF MIND

Heat recovery units with EC Technology motors allow speed adjustment by means of a 0-10 V signal. This allows airflow rates to be tailored to optimal requirements, giving considerable energy savings.

OUR OBJECTIVES

- Energy saving and the subsequent reduction in the use of natural resources.
- Energy efficiency improvement.
- Reduction in noise pollution.
- Environmental protection.
- Reduction in CO2 emissions.



Energy efficiency

We recommend installing heat recovery units in any air conditioned premise to obtain important energy savings.



High efficiency motors with proportional control capacities.

HEAT EXCHANGER

The heat exchanger component in the recovery unit transfers heat from the exhaust air extraction circuit to the external clean air supply circuit. The greater the thermal efficiency of the exchanger, the less the need to supply additional air conditioning.

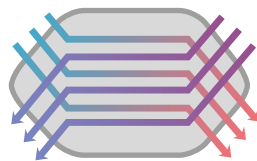

Counterflow heat exchanger

85-90% thermal efficiency With no leaks between air circuits

The exchangers can be of the sensible heat or enthalpy type. Sensible heat exchangers only recover the heat present in air, whereas the enthalpy exchanger also recovers moisture, which means that efficiency can be higher in very humid environments (although they require regular cleaning for safe operation)

TYPES OF INSTALLATION



In false ceiling

Low-profile equipment with access to components through the side or base.

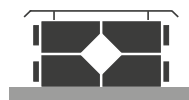

On the roof

Equipment for outdoor operation, with lateral access to components. They may require accessories such as roof support pads, rain shields or other elements.



In technical room

Compact equipment with lateral access to components.

THERMAL BY-PASS



The BY-PASS device diverts the air flow and prevents it from passing through the heat recovery unit and the thermal exchange of the unit.

THE BEST THERMAL INSULATION

For some time now, SODECA has endorsed the international goal of improving the energy efficiency of buildings. For this reason, the high efficiency recovery models listed in this catalogue (RECUP/EC BS and RECUP/EC H) incorporate **EPS panels with a thermal bridge break**, to provide a better insulation.

AUTOMATIC CONTROL



In heat recovery units, automatic control may offer a wide range of functions, depending on the equipment series or models. The most important are:

- Programmable Timer.
- Flow control based on CO2 levels.
- Connection to a centralised building management control system (BMS), normally using the MODBUS RTU protocol.

FILTERS

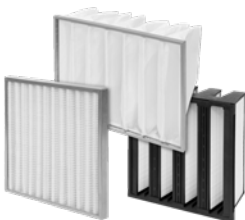

Filters retain particles that affect air quality and they must be replaced after period of time. The load loss of the filters gradually increases.

Some pieces of equipment have load loss control elements aimed at optimising the filter replacement process.

- Pressure sensors: Small sensors that enable load loss detection in the filtration stages.
- Pressure switch: Pressure switch that switches an electric circuit on and off based on the filter load loss reading.

















Depending on its configuration, the equipment may have:

- A pre-filter stage to guarantee the correct operation of the equipment. Depending on the system requirements, the filter grades may be: M6+F8.
- Final filter stages to ensure the quality of the air supplied to the premises, where the filter grades may be: F7+F9 or even HEPA, according to the IDA/ODA category.

HEAT RECOVERY UNITS











DOMESTIC RESIDENTIAL

	UNIREC	VENUS	REB	REB-HEPA
				
<i>Type of installation</i>				
BY-PASS	N	N	Y	Y
Standard version depending on the bacteria				
Motorisations				
Thermal efficiency %	90	93	80	82
Auto time programming	N	Y	N	N
Speeds	3	3	3	3
CO ₂ / Pressure	N	depending on the model	N	N
RTU Modbus	N	N	N	N
Pre-filters	Y	Y	Y	G4
Final filters	Y	Option CJFILTER/REC	Option CJFILTER/REC	HEPA-H13



COMMERCIAL HIGH EFFICIENCY

	RECUP/EC BS	RECUP/EC H
		
<i>Type of installation</i>		
BY-PASS	Y	Y
Standard version depending on the bacteria		
Battery modules	YES (on request)	YES (on request)
Motorisations		
Thermal efficiency %	85-90	85-90
Auto time programming	Y	Y
Speeds	VSD	VSD
CO ₂ / Pressure	Y	Y
RTU Modbus	Y	Y
Pre-filters	F6/F7	G4+F6/F7
Final filters	F8	F9

PORTABLE AIR PURIFIERS

25 PURI
Portable air purifier



27 UPM/EC
Mobile air purifying units, designed for cleaning, odor removal and indoor air purification in any type of premises



27 UPM/EC-CG
Mobile air purifying units, designed for odour removal, purification and disinfection of indoor air using UVc ultraviolet light technology



29 UPM/EC PCO
Mobile air purifying units with photocatalysis-based technology

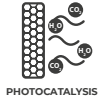

31 UPM/EC FE
Mobile air purifying units with high-efficiency electrostatic filters. For use in applications with greasy particles



33 UPA
Units designed for cleaning and purifying indoor air. For use in areas of high occupancy, pharmaceutical industry and hospitals

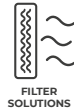

33 UPA-CG
Mobile air purifying units, designed for odour removal, purification and disinfection of indoor air using UVc ultraviolet light technology



35 UPH/EC
Mobile air purifying units



35 UPH/EC-CG
Mobile air purifying units, with UVc ultraviolet light technology



FILTRATION AND DISINFECTION UNITS

38 SV/FILTER
Low noise in-line duct extractors with different stages of filtration



42 SV/FILTER-CG
Air purifying units with UVc germicidal chamber in line for ducts and different stages of filtration



46 SV/FILTER/EC
Filtration units for circular ducts and EC Technology motor



51 SV/HEPA/EC
HEPA filtration units for circular ducts and EC Technology motor



56 UPT
Ceiling units for purifying and disinfecting air using HEPA H14 filtration



58 CJK/FILTER/EC
Air purifying units for circular ducts, 25 mm acoustic casing, EC Technology motor



58 CJK/FILTER/EC-CG
Unidades purificadoras de aire para conductos circulares, envoltorio acústica de 25 mm, motor EC Technology y con tecnología de luz ultravioleta UVc



63 CJB/ALF
Ventilation units with pre-lacquered sheet metal, built-in filter and aluminum profiles



67 CJBX/ALF
Belt driven ventilation units with pre-lacquered sheet, built-in filters and aluminium profiles



77 UFRX/ALS PCO
Air purifying units with photocatalysis-based technology



81 UFRX/ALS FE
Air purifying units with high efficiency electrostatic filters. For use in applications with greasy particles



85 UPC/EC PCO
Air purifying units with photocatalysis-based technology

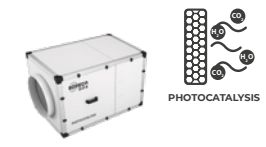

88 UPC/EC FE
Air purifying units with high efficiency electrostatic filters. For use in applications with greasy particles

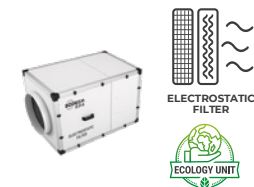

91 UFR
Acoustically insulated filtration units, backward curved impeller fans with different filtration stages depending on the model



95 UFX
Acoustically insulated filtration units, equipped with double inlet fans and different filtration stages depending on the model



105 UFRX
Acoustically insulated filtration units, highly robust backward curved impeller and different filtration stages depending on the model



115 CJFILTER/REC
Filter boxes for circular and rectangular ducts, equipped with different types of filter depending on the model



117 MF
Filter units without a fan but with various filter options



124 MCA
Filter units without fans, with active carbon filter cartridges



GERMICIDAL CHAMBERS

128 CG/FILTER-UVc
Air purifying units for circular ducts, with 25 mm acoustic surround for noise reduction, without fan



132 CG/LP-UVc
UVc germicidal chamber without fan for use in circular ducts. Ideal for installation in existing air conditioning and ventilation systems

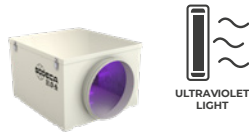

132 CGR-UVc
UVc germicidal chamber without fan for use in rectangular ducts. Ideal for installation in existing air conditioning and ventilation systems

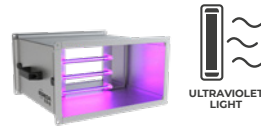

137 MPCO
Filter units without fans, with photocatalysis technology

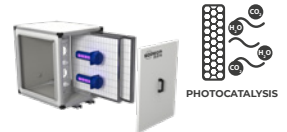

140 MFE
Filter units without fans, with high efficiency electrostatic filters



HEAT RECOVERY UNITS

144 UNIREC
High efficiency single zone heat recovery ventilators for domestic installations



146 VENUS
High efficiency single zone heat recovery ventilators for residential installations



149 REB
Heat recovery units with EC Technology motor and built-in by-pass



152 REB-HEPA
Heat recovery units with EC Technology motor, built-in by-pass and HEPA filter



154 RECUP/EC-BS
Heat recovery units with counter flow plate exchanger, automatic control and EC Technology motors, for installation in false ceilings



159 RECUP/EC-H
Heat recovery units with counter flow exchanger, automatic control and EC Technology motors, for installation on a roof or in a plant room



MONITORING AND CONTROL

168 MICA-LITE/W
Air quality monitor to ensure correct ventilation in enclosed spaces



169 CAP/EC
Intelligent control for the regulation of equipment with EC Technology fans prepared for external air quality probes



170 SI-PM2.5+VOC
Intelligent probe for CAP/EC control, for the regulation of ventilation based on the parameters of solid particles and volatile organic compounds



170 SI-CO2+VOC
Intelligent probe for CAP/EC control, for the regulation of ventilation based on CO2 and volatile organic compounds parameters



PORTABLE AIR PURIFIERS



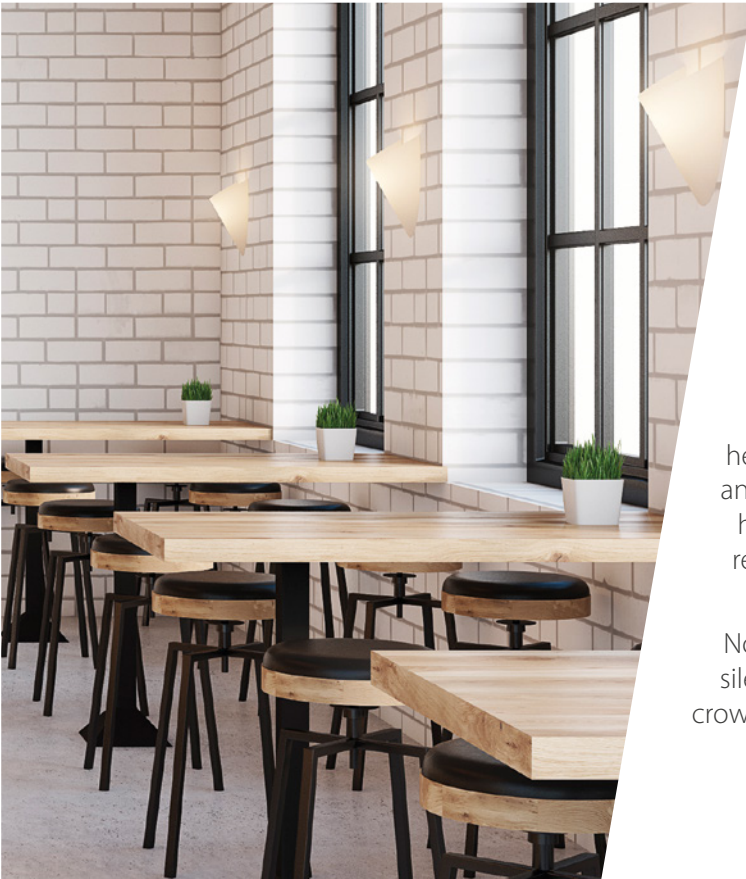

Indoor air purifiers are a great advance for health, since they eliminate dust particles, mites and a multitude of bacteria and microorganisms harmful to people, as well as unpleasant odors, reducing respiratory conditions such as asthma and allergies of all type.

Nowadays, it is essential to have an efficient and silent air purifier both at home, in the office or in crowded public places, to ensure an air quality free of organisms harmful to health.

MODEL PURI

The system incorporates a digital panel and an air quality indicator that constantly and automatically displays the air quality based on the parameters of concentration of fine particles in the air.



Model	PURI-50
Maximum effective working area (m ²)	45-50
Air flow rate (m ³ /h)	400
Noise level (dB)	<56
Supply voltage (V)	100-240V 50/60Hz
Power consumption (W)	50
Approx. weight (Kg)	4,8
Size — height x length x width (mm)	562 x 270 x 303
Timer (h):	2/4/8



Very good
PM_{2.5} < 75 µg/m³



Fair
75 < PM_{2.5} < 150 µg/m³



Poor
PM_{2.5} > 150 µg/m³

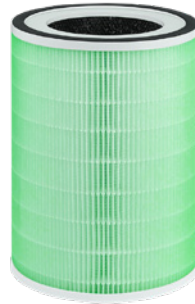

Thanks to the circular column type design, it allows the air to be drawn in all around its contour, increasing its efficiency and filtration performance.

Excellent filtration power thanks to a drum type filter with four stages of filtration: the first stage captures large PM10 particles such as dust, fibres and lint; the second stage eliminates bacteria; the third stage captures particles between sizes PM0.3 and PM2.5, such as pollen and spores; and the fourth stage eliminates foul odours such as those generated by tobacco, cooking and pets.

Technical characteristics

- It incorporates a high-performance EC Technology motor.
- HEPA H13 type filters with a filtration efficiency of 99.95%.
- Digital control panel.
- Air quality control sensor.
- Color indicator for air quality check.
- Automatic, manual and timer operating modes.
- Anti-bacteria and virus stage with UVC ultraviolet led.
- Different stages of filtration:
 - Large PM10 particles filter.
 - Anti-bacterial filter comprising silver and copper ions.
 - HEPA H13 fine particles filter.
- Filter for volatile organic compounds and bad odors.



UPM/EC

Mobile air purifying units, designed for cleaning, odor removal and indoor air purification in any type of premises

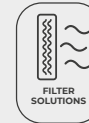

Characteristics:

- 40 mm aluminium profile structure.
- Wheel kit.
- Plug & Play system with integrated control.
- Adjustable filter change alarm.
- Covers with a high quality, 25 mm thick acoustic casing made of prefinished sheet.
- Backward curved impeller.
- Dishwasher safe pre-filter.
- Filtration stages, depending on model:
 - F9.
 - HEPA H14.
- Active carbon filter for odour removal.
- Inspection cover for filter maintenance and replacement.
- Germicidal chamber with Uvc ultraviolet lamps (256 nm), depending on model.

Motor:

- High efficiency external rotor EC Technology motors, adjustable via 0-10 V signal.
- Single phase 200-240 V 50/60 Hz.
- Maximum temperature of air to be carried: -25 °C +60 °C.

Finish:

- Structure of anodised aluminium profiles and pre-lacquered sheet metal with 25 mm thermal and acoustic insulation panels.

On request:

- Particle sensor for automatic control.
- Different stages of filtration.

Order code

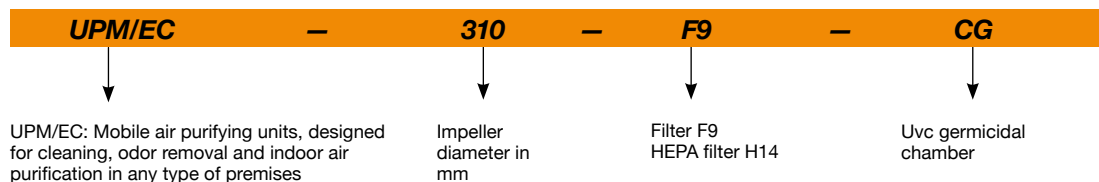

Filter characteristics

Filters	EN 779 Em	EN 1822	ISO 16890			
			ISO ePM ₁	ISO ePM _{2,5}	ISO ePM ₁₀	ISO COARSE
F9	95%	-	>80%	>95%	>95%	-
HEPA H14	-	>99.995%	-	-	-	-

Technical characteristics

Model	Recommended effective working area ¹ (m ²)		Speed (r/min)	Maximum power (W)	Power supply	Sound pressure level at 50% of max speed. ² dB (A)	Maximum flow rate (m ³ /h)		Approx. weight (Kg)
	Filters (F9)	Filters (H14)					Filters (F9)	Filters (H14)	
UPM/EC-310	65	55	1920	175	200-240V 50/60Hz 1Ph	47	550	450	55
UPM/EC-310/H	115	90	2377	450	200-240V 50/60Hz 1Ph	55	950	750	57
UPM/EC-400	190	155	1550	460	200-240V 50/60Hz 1Ph	47	1600	1300	69

¹Recommended effective working area with a 3-meter-high premises.

²Irradiated sound pressure level in dB(A) at a distance of 3 m.

Technical characteristics of the UVC germicidal chamber

According to the model, these purification units can integrate a germicidal chamber, built with UVC ultraviolet lamps in a 256 nm spectrum, a wave width indicated to inactivate a wide variety of microorganisms by absorbing short wavelength energy through DNA and RNA.

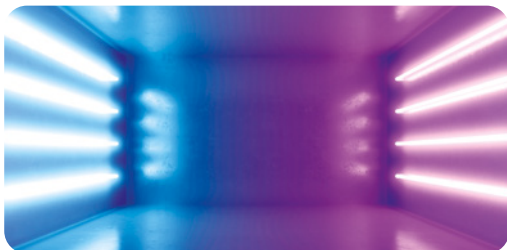

Model	Number of lamps	Total electrical power (W)	Total Uvc radiation power (W)	Radiation dose (mJ/cm ²) *
UPM/EC-310	6	54	16.8	6.7
UPM/EC-310/H	6	54	16.8	4.5
UPM/EC-400	4	102	28	5.4

*Minimum dose calculated based on flow with filters: H14.



Erp. (Energy Related Products)

Information on Directive 2009/125/EC can be downloaded from the SODECA website or the QuickFan selector programme.

Dimensions mm

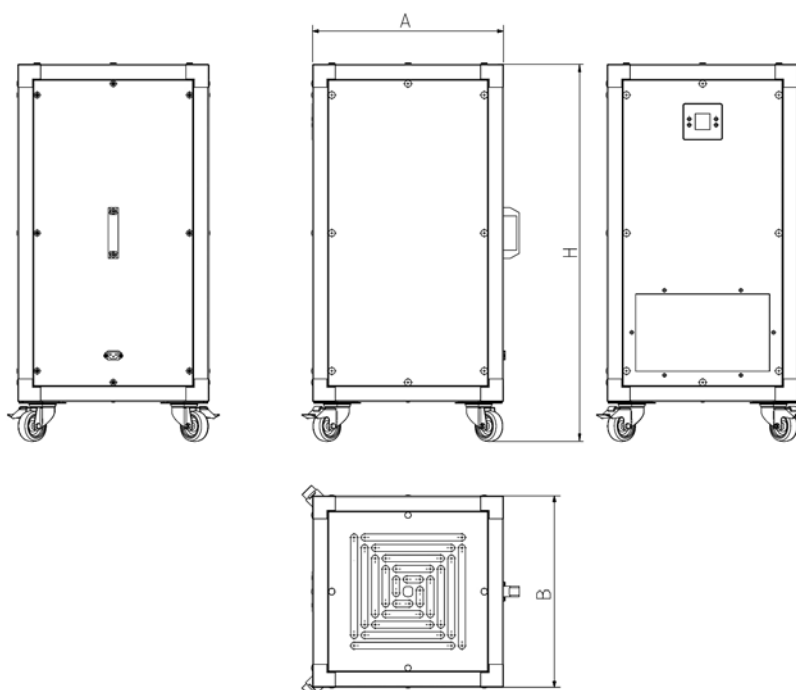

	A	B	H
UPM/EC-310	500	500	985
UPM/EC-400	701	701	1186

UPM/EC PCO

Mobile air purifying units with photocatalysis-based technology

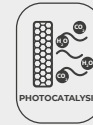

Mobile air purification units with technology based on photocatalysis, designed for disinfecting and purifying indoor air and surfaces in any type of high occupancy premise.

Characteristics:

- 40 mm aluminium profile structure.
- Wheel kit.
- Plug & Play system with integrated control.
- Adjustable filter change alarm.
- Covers with a high quality, 25 mm thick acoustic casing made of prefinished sheet.
- Backward curved impeller.
- Washable pre-filter.
- Built-in photocatalyst device with negative ionisation.
- Additional filtration stages: F7 + HEPA H14.

- Inspection cover for filter maintenance and replacement.

Motor:

- High efficiency EC Technology motors, outer rotor adjustable via 0-10 V signal.
- Single-phase 200-240 V 50/60 Hz and three-phase 380-480 V 50/60 Hz.
- Maximum temperature of air to be carried: -25 °C +60 °C.

Finish:

- Structure of anodised aluminium profiles and pre-lacquered sheet metal with 25 mm thermal and acoustic insulation panels.

On request:

- Particulate matter sensor for automatic control SI-PM2.5+VOC or SI-CO2+VOC.

PORTABLE AIR PURIFIERS

Order code

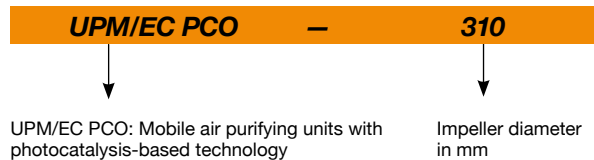

Filter characteristics

STANDARD FILTERS	EN 779	EN 1822	ISO 16890			
	<i>Em</i>		ISO ePM ₁	ISO ePM _{2,5}	ISO ePM ₁₀	ISO COARSE
F7	90%	-	>50%	>65%	>85%	-
H14	-	>99.995%	-	-	-	-

Technical characteristics

Model	Recommended effective working area ¹	Speed	Power	Power supply	Sound pressure level at 50% of max speed. ²	Maximum flow rate	Approx. weight
	(m ²)	(r/min)	(W)		dB (A)	(m ³ /h)	(Kg)
UPM/EC PCO-310	100	2377	450	200-240V 50/60Hz 1Ph	55	800	56
UPM/EC PCO-400	160	1550	460	200-240V 50/60Hz 1Ph	47	1300	98
UPM/EC PCO-500	240	1250	1150	380-480V 50/60Hz 3Ph	51	1950	166

¹Recommended effective working area with a 3-meter-high premises.

² Irradiated sound pressure level in dB(A) at a distance of 3 m.



Erp. (Energy Related Products)

Information on Directive 2009/125/EC can be downloaded from the SODECA website or the QuickFan selector programme.

Dimensions mm

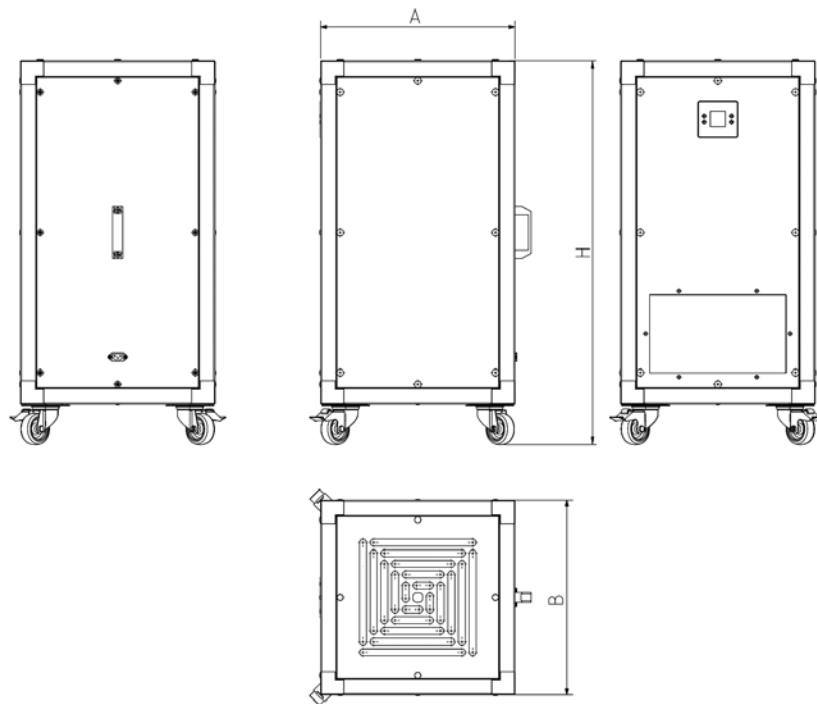

	A	B	H
UPM/EC PCO-310	500	500	985
UPM/EC PCO-400	701	701	1186
UPM/EC PCO-500	901	901	1386

UPM/EC FE

Mobile air purifying units with high-efficiency electrostatic filters. For use in applications with greasy particles

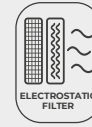

Air purifier units with high efficiency electrostatic filters, specifically designed for cleaning and purifying indoor areas where large amounts of grease or suspended particulate matter can be present.

Characteristics:

- 40 mm aluminium profile structure.
- Wheel kit.
- Plug & Play system with integrated control.
- Adjustable filter change alarm.
- Covers with a high quality, 25 mm thick acoustic casing made of prefinished sheet.
- Backward curved impeller.
- Washable pre-filter.
- High efficiency (95% ePM1) electrostatic filter device with built-in thermal sensor.
- Additional active carbon filter stage.
- Inspection cover for filter maintenance and replacement.
- Grease-collection tray.

Motor:

- High efficiency EC Technology motors, outer rotor adjustable via 0-10 V signal.
- Single-phase 200-240 V 50/60 Hz and three-phase 380-480 V 50/60 Hz.
- Maximum temperature of air to be carried: -25 °C +60 °C.

Finish:

- Structure of anodised aluminium profiles and pre-lacquered sheet metal with 25 mm thermal and acoustic insulation panels.

On request:

- Negative ion ioniser.
- Particulate matter sensor for automatic control SI-PM2.5+VOC or SI-CO2+VOC.

Order code

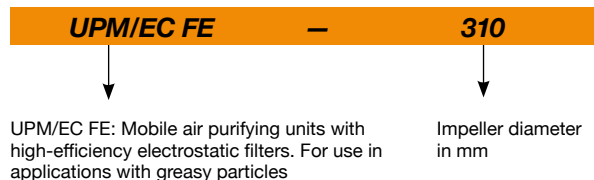

Filter characteristics

ELECTROSTATIC FILTER	ePM ₁				ACTIVE CARBON FILTER	EN 779 Em	EN 1822	ISO 16890					
	95%	90%	80%	70%				ISO ePM ₁	ISO ePM _{2.5}	ISO ePM ₁₀	ISO COARSE		
Filtration class EN 779	-	-	F9	F8	F7								
Air speed (m/s)	1	2	2.5	3	4								
Air flow capacity (%)	40	50	65	75	100								
Pressure drop (Pa)	10	17	24	37	64								
						FCA	90%	-	-	-	-	-	60%

Technical characteristics

Model	Recommended effective working area ¹ (m ²)		Speed (r/min)	Power (W)	Power supply	Sound pressure level at 50% of max speed. ² (dB (A))	Maximum flow rate (m ³ /h)		Approx. weight (Kg)
	Grease particles	Dry particles					Grease particles	Dry particles	
UPM/EC FE-310	65	85	1920	175	200-240V 50/60Hz 1Ph	47	525	700	60
UPM/EC FE-400	195	245	1550	460	200-240V 50/60Hz 1Ph	47	1575	2000	111
UPM/EC FE-500	315	385	1250	1150	380-480V 50/60Hz 3Ph	51	2550	3120	184

¹Recommended effective working area with a 3-meter-high premises.

² Irradiated sound pressure level in dB(A) at a distance of 3 m.



Erp. (Energy Related Products)

Information on Directive 2009/125/EC can be downloaded from the SODECA website or the QuickFan selector programme.

Dimensions mm

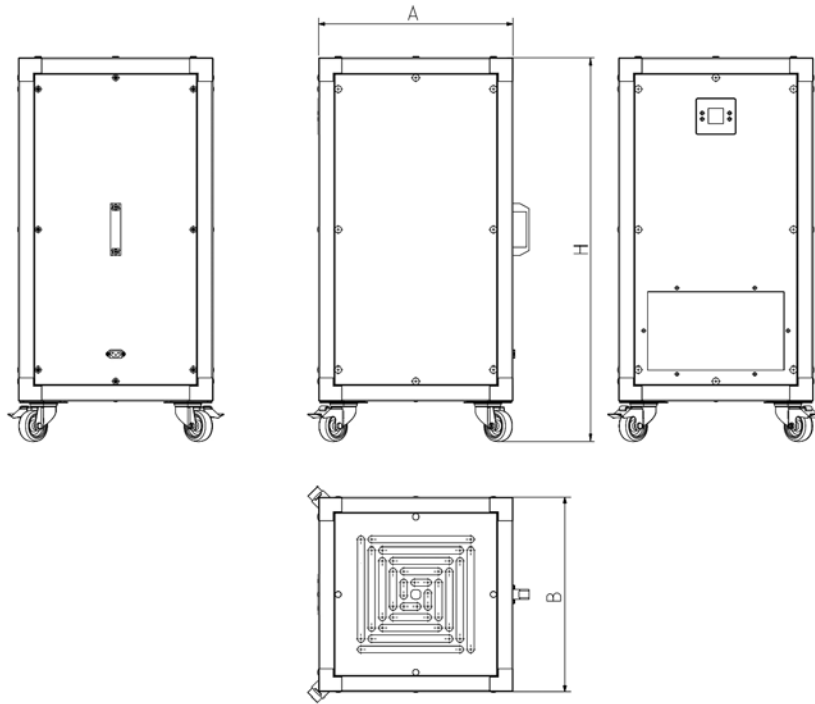

	A	B	H
UPM/EC FE-310	500	500	985
UPM/EC FE-400	701	701	1186
UPM/EC FE-500	901	901	1386

UPA

Units designed for cleaning and purifying indoor air. For use in areas of high occupancy, pharmaceutical industry and hospitals

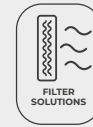

Units specifically designed for cleaning and purifying indoor air, in any type of premises and mainly in areas with high occupancy, also indicated for the pharmaceutical industry and hospital applications.

Characteristics:

- Plug Fan type fans with EC Technology.
- Efficient, adjustable and low noise level equipment.
- Filtration stages, depending on model:
- First stage of F7 Filtering.
- Active carbon filter.
- Final filter F9.
- HEPA H14 final filter, 99.99% efficiency.
- UVC germicidal chamber, according to order code.
- Control panel with on/off and dirty filters indicator.
- Led indicator germicidal chamber operation.

- Completely removable for cleaning and maintenance.
- Panels with interior insulation.

Motor:

- High efficiency, external rotor, EC Technology motors, incorporating constant flow regulation, with two pre-adjustable set points.
- Single-phase 200-230 V 50/60 Hz.

Finish:

- Frames made form aluminum section and 25 mm insulated panels, pre-finished exterior, galvanized interior.

On request:

- Drive module 1 front grill.
- Drive module with circular ducts.
- Equipped with wheels.

Order code

UPA – **UV** – **1500** – **F9** – **CG**

UPA: Units designed for cleaning and purifying indoor air. For use in areas of high occupancy, pharmaceutical industry and hospitals

UV: Vertical unit
UH: horizontal unit

Air flow rate (m³/h)

Filter F9
HEPA filter H14

Uvc germicidal chamber

Technical characteristics

Model	Recommended effective working area ¹	Maximum flow rate		Available pressure	Power supply	Noise level	Fan	Approx. weight
	(m ²)	(m ³ /h)	(cfm)	(Pa)	(V)	(dB (A))	(kW)	(Kg)
UPA-UV-1500	200-350	1,500	883	250	200-230V 50/60Hz 1Ph	47	0.76	113
UPA-UV-3000	300-450	3,000	1766	250	200-230V 50/60Hz 1Ph	51	1.35	140
UPA-UV-4500	450-900	4,500	2649	300	200-230V 50/60Hz 1Ph	55	2.7	177
UPA-UV-6000	900-1,100	6,000	3531	250	200-230V 50/60Hz 1Ph	59	5.4	215
UPA-UH-1500	200-350	1,500	883	250	200-230V 50/60Hz 1Ph	47	0.76	108
UPA-UH-3000	300-450	3,000	1766	250	200-230V 50/60Hz 1Ph	52	1.52	138
UPA-UH-4500	450-900	4,500	2649	250	200-230V 50/60Hz 1Ph	55	2.7	135
UPA-UH-6000	900-1,100	6,000	3531	250	200-230V 50/60Hz 1Ph	59	5.4	155

¹Recommended effective working area with a 3-meter-high premises.

*Available pressure with G4 and F9 filter.

Construction

Vertical Unit (UV)

Vertical Unit (UV) ideal for direct use on the rooms to be purified, it can also be supplied on request with an impulsion module with outlet through diffusion grille and with wheels if necessary.

Horizontal Unit (UH)

Horizontal Unit (HU) conceived to be installed in false ceilings and connected through ducts to the premises where the air needs to be treated.

Dimensions mm

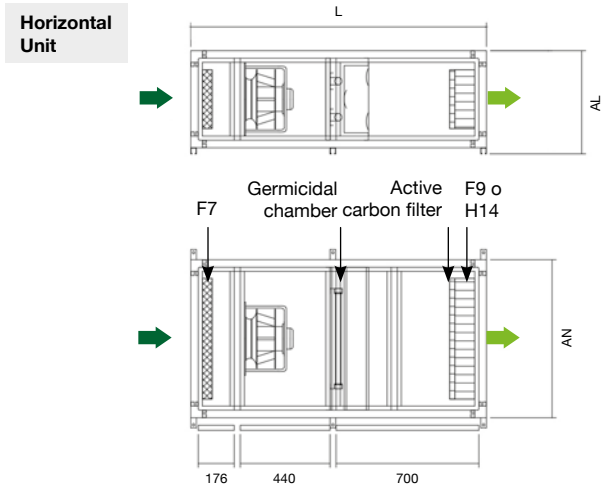
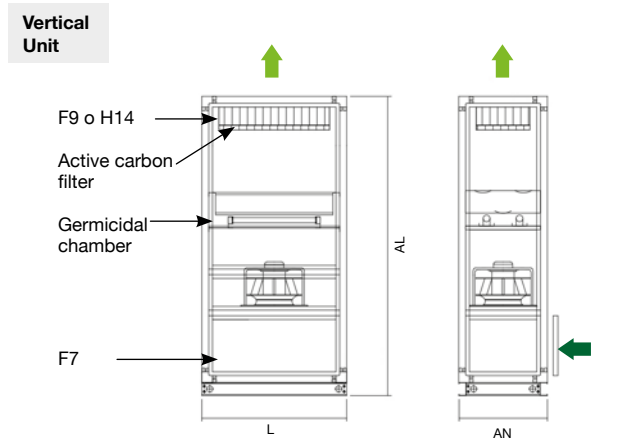

	L	AN	H
UPA-UV-1500	774	474	1600
UPA-UV-3000	774	779	1600
UPA-UV-4500	1079	779	1600
UPA-UV-6000	1504	779	1600

Data subject to change without prior notice.

	L	AN	H
UPA-UH-1500	1450	774	479
UPA-UH-3000	1450	1366	479
UPA-UH-4500	1450	1069	779
UPA-UH-6000	1450	1366	779

Data subject to change without prior notice.

Drive modules

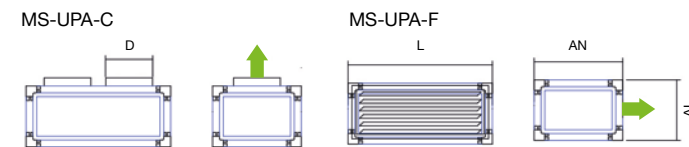

	L	AN	AL	D	Number of ducts	Approx. weight (Kg)
MS-UPA-1500	774	474	324	250	2	25
MS-UPA-3000	774	779	490	250	4	33
MS-UPA-4500	1079	779	490	250	6	42
MS-UPA-6000	1504	779	490	-	-	55

Filtered

These air purification units are equipped with filters capable of removing at least 70% of particles larger than 0.4µm. The standard model comes with a first G-4 filter stage and a final F-9 filter, it also incorporates as standard, an activated carbon stage, designed to remove stale odours produced during everyday use of the premises. Depending on model type H14 HEPA filters can be installed with a minimum retention capacity of 99.95% for particles larger than 0.3µm.

Filters	EN 779 Em	EN 1822	ISO 16890			
			ISO ePM ₁	ISO ePM _{2.5}	ISO ePM ₁₀	ISO COARSE
G4	90%	-	-	-	-	>90%
F7	90%	-	>50%	>65-95%	>85%	-
F9	95%	-	>80%	>95%	>95%	-
HEPA H14	-	>99.995%	-	-	-	-

Technical characteristics of the UVC germicidal chamber

According to the model, these purification units can integrate a germicidal chamber, built with UVC ultraviolet lamps in a 256 nm spectrum, a wave width indicated to inactivate a wide variety of microorganisms by absorbing short wavelength energy through DNA and RNA.

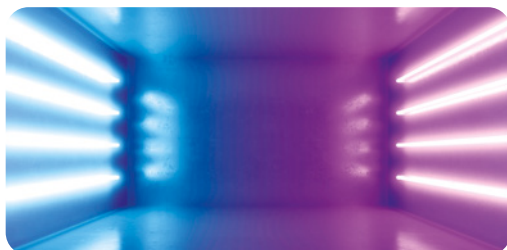

Model	Number of lamps	Total electrical power (W)	Total Uvc radiation power (W)	Radiation dose (mJ/cm ²) *
CG-UV-1500	3	48	21	4.85
CG-UV-3000	7	112	48	5.66
CG-UV-4500	4	216	70	5.39
CG-UV-6000	14	224	98	5.47
CG-UH-1500	3	48	21	5.17
CG-UH-3000	2	150	51	6.28
CG-UH-4500	4	216	70	5.89
CG-UH-6000	14	224	98	6.04

*Minimum dose calculated based on flow with filters: F7+F9.

UPH/EC

Mobile air purifying units

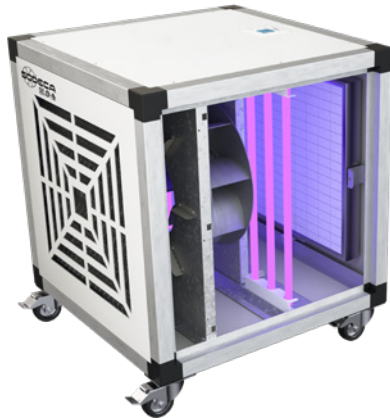
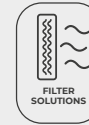

Mobile air purification units with EC Technology motors and a 25 mm thick acoustically insulated casing to reduce noise.

Characteristics:

- 40 mm aluminium profile structure.
- Wheel kit.
- Plug & Play system with integrated control.
- Covers with a high quality, 25 mm thick acoustic casing made of prefinished sheet.
- Backward curved impeller.
- Filtration stages, depending on model:
 - F9.
 - HEPA H14.
- Active carbon filter for odour removal.
- Adjustable filter change alarm.
- Germicidal chamber with UVc ultraviolet lamps (256 nm), depending on model.
- Inspection cover for filter maintenance and replacement.

- Air inlet nozzle with diffusers that increase the efficiency of the fan.

Motor:

- High efficiency external rotor EC Technology motors, adjustable via 0-10 V signal.
- Single phase 200-240 V 50/60 Hz.
- Maximum temperature of air to be carried: -25 °C +60 °C.

Finish:

- Structure of anodised aluminium profiles and pre-lacquered sheet metal with 25 mm thermal and acoustic insulation panels.

On request:

- Particle sensor for automatic control.
- Different stages of filtration.

Order code

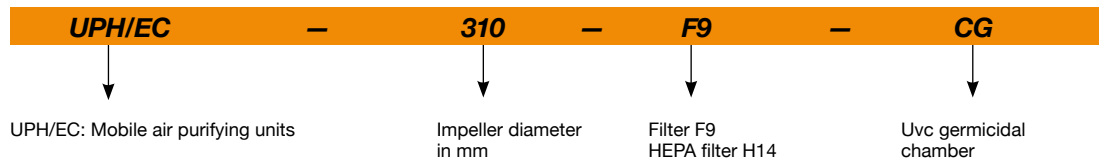

Filter characteristics

Filters	EN 779 Em	EN 1822	ISO 16890			
			ISO ePM ₁	ISO ePM _{2,5}	ISO ePM ₁₀	ISO COARSE
F9	95%	-	>80%	>95%	>95%	-
HEPA H14	-	>99.995%	-	-	-	-

Technical characteristics

Model	Recommended effective working area ¹ (m ²)		Speed (r/min)	Maximum power (W)	Power supply	Sound pressure level at 50% of max speed. ² dB (A)	Maximum flow rate (m ³ /h)		Approx. weight (Kg)
	Filters (F9)	Filters (H14)					Filters (F9)	Filters (H14)	
UPH/EC-220	50	-	3265	176	200-240V 50/60Hz 1Ph	48	420	-	32
UPH/EC-250	60	-	2850	180	200-240V 50/60Hz 1Ph	49	500	-	33
UPH/EC-310	65	55	1920	175	200-240V 50/60Hz 1Ph	47	550	450	34
UPH/EC-400	190	155	1550	460	200-240V 50/60Hz 1Ph	47	1600	1300	68

¹Recommended effective working area with a 3-meter-high premises.

² Irradiated sound pressure level in dB(A) at a distance of 3 m.

Technical characteristics of the UVC germicidal chamber

According to the model, these purification units can integrate a germicidal chamber, built with UVC ultraviolet lamps in a 256 nm spectrum, a wave width indicated to inactivate a wide variety of microorganisms by absorbing short wavelength energy through DNA and RNA.

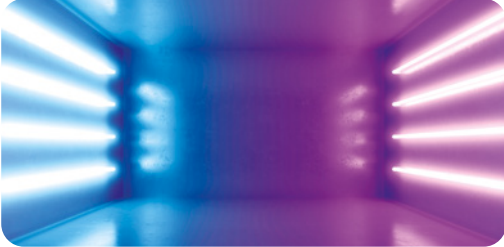

Model	Number of lamps	Total electrical power (W)	Total Uvc radiation power (W)	Radiation dose (mJ/cm ²) *
UPH/EC-220	6	54	16.8	7.2
UPH/EC-250	6	54	16.8	6.0
UPH/EC-310	6	54	16.8	6.7
UPH/EC-400	4	102	28	5.4

Minimum dose calculated based on the maximum flow rate.



Erp. (Energy Related Products)

Information on Directive 2009/125/EC can be downloaded from the SODECA website or the QuickFan selector programme.

Dimensions mm

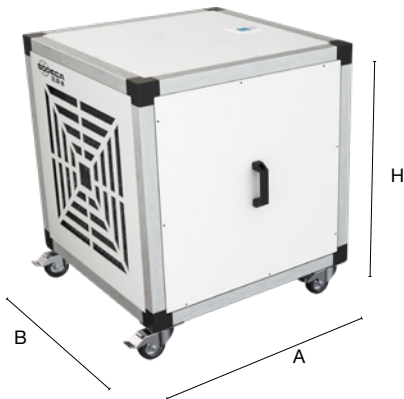

	A	B	H
UPH/EC-220	500	542	642
UPH/EC-250	500	542	642
UPH/EC-310	500	542	642
UPH/EC-400	700	742	842

Data subject to change without prior notice.

FILTRATION AND DISINFECTION UNITS



SV/FILTER

Low noise in-line duct extractors with different stages of filtration

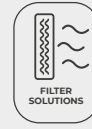

Characteristics:

- Acoustic casing covered with sound absorbing material.
- Standardised inlet and outlet flanges allowing for easy installation in ducts.
- G4 + F6, F6 + F8 and F7 + F9 filters according to model.
- Easy access inspection and cleaning hatch.

- Access doors to facilitate maintenance and cleaning.

Motor:

- External rotor motors with built-in thermal protector, class F, with ball bearings, IP54 protection.
- Single-phase 230 V 50/60 Hz adjustable.
- Maximum temperature of air to be carried: +50 °C.

Construction:

- Galvanized steel sheet casing.
- Backward curved impellers, except for models 125 and 150 which have multi-bladed impellers. Supplied with four support feet for easy mounting.

Finish:

- Anti-corrosive finish in polyester resin, polymerised at 190 °C, after degreasing with phosphate-free nanotechnology treatment.



Order code

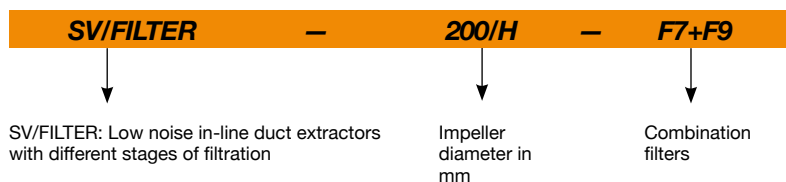

Technical characteristics

Model	Speed (r/min)	Maximum admissible current (A) 230V	Installed power (kW)	Maximum flow rate (m³/h)			N° Pré-filters	N° Filters	Filter dimensions mm		Approx. weight (Kg)	According ErP
				Filters (G4+F6)	Filters (F6+F8)	Filters (F7+F9)			Filters (G4)	Filters (F)		
SV/FILTER-125/H	2220	0.65	0.08	300	255	240	1	1	282x194x48	282x194x98	9.1	2018
SV/FILTER-150/H	2200	1.25	0.17	445	385	360	1	1	334x216x48	334x216x98	12.3	2018
SV/FILTER-200/H	1240	0.85	0.12	590	430	375	1	1	389x248x48	389x248x98	15.1	2018
SV/FILTER-250/H	2380	0.95	0.14	660	560	525	1	1	414x267x48	414x267x98	17.8	2018
SV/FILTER-315/H	1330	0.75	0.12	1035	850	790	1	1	513x344x48	513x344x98	26.4	2018
SV/FILTER-350/H	1280	0.95	0.14	1550	1270	1180	1	1	602x385x48	602x385x98	36.3	2018
SV/FILTER-400/H	1330	1.80	0.30	2050	1720	1600	1	1	660x405x48	660x405x98	46.4	2018

Erp. (Energy Related Products)

Information on Directive 2009/125/EC can be downloaded from the SODECA website or the QuickFan selector programme.

Dimensions mm

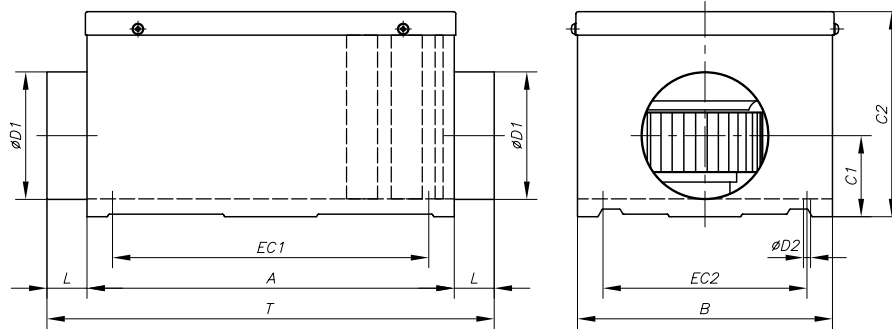

	A	B	C1	C2	Ø D1	L	Ø D2	EC1	EC2	T
SV/FILTER-125/H	657	290	80	222	125	36.5	7	607	240	730
SV/FILTER-150/H	700	340	92	244	150	36.5	7	650	290	773
SV/FILTER-200/H	775	395	117	273	200	36	7	725	345	847
SV/FILTER-250/H	775	420	140	293	250	50	7	725	345	875
SV/FILTER-315/H	860	520	175	371	315	48	8.5	809	469	976
SV/FILTER-350/H	960	610	200	415	355	48	8.5	909	564	1071
SV/FILTER-400/H	1035	670	219	462	400	38	8.5	984	624	1181

Characteristic curves

Equipment curve according to built-in filters **1** G4+F6 **2** F6+F8 **3** F7+F9

Static pressure Dynamic pressure Absorbed power

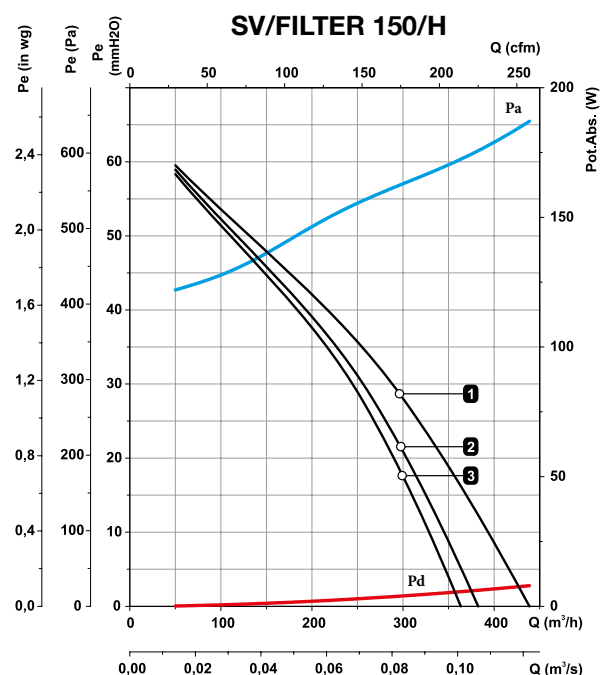
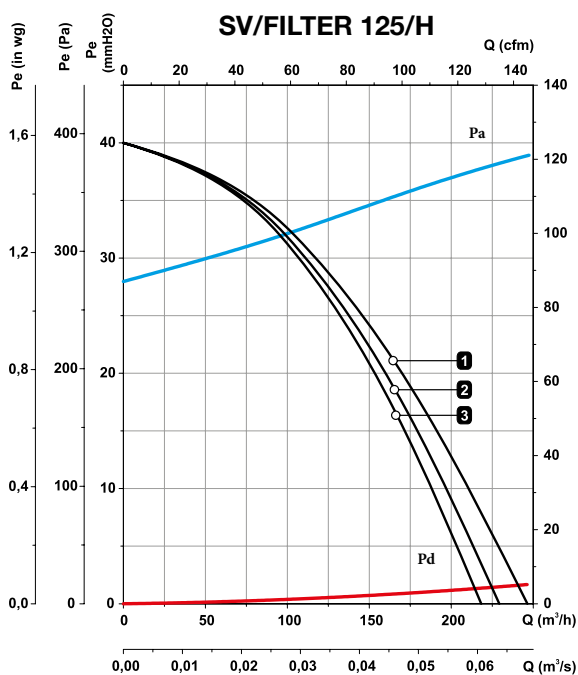

Characteristic curves

Equipment curve according to built-in filters **1** G4+F6 **2** F6+F8 **3** F7+F9

Static pressure

Dynamic pressure

Absorbed power

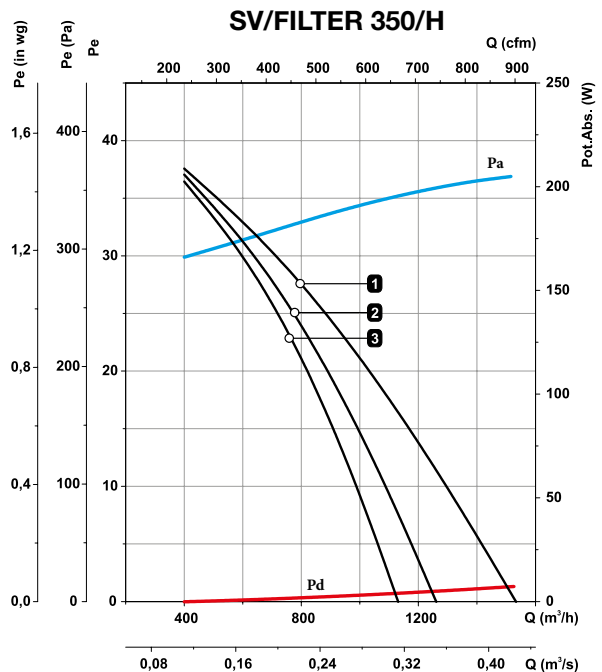
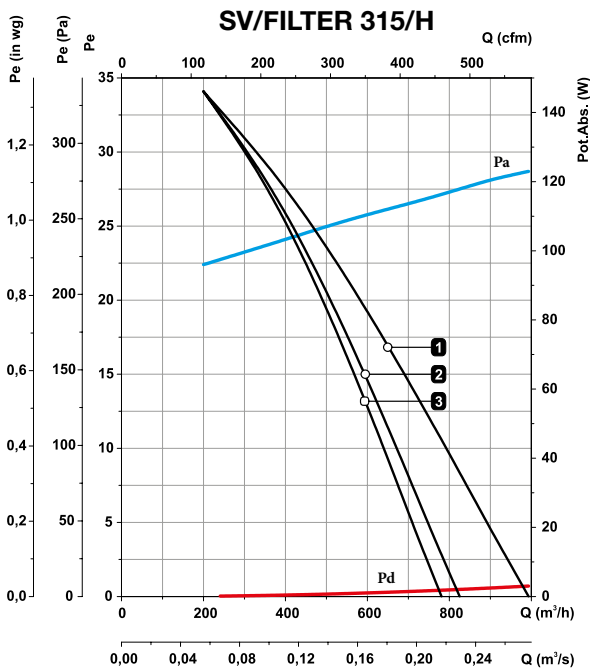
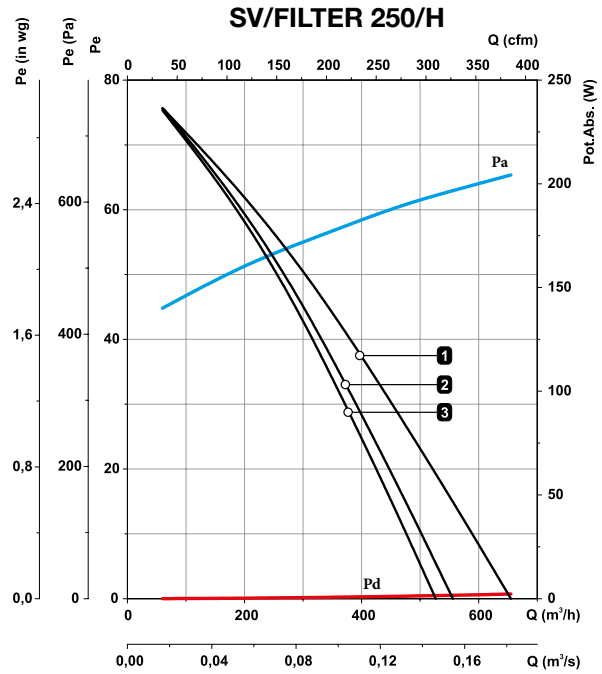
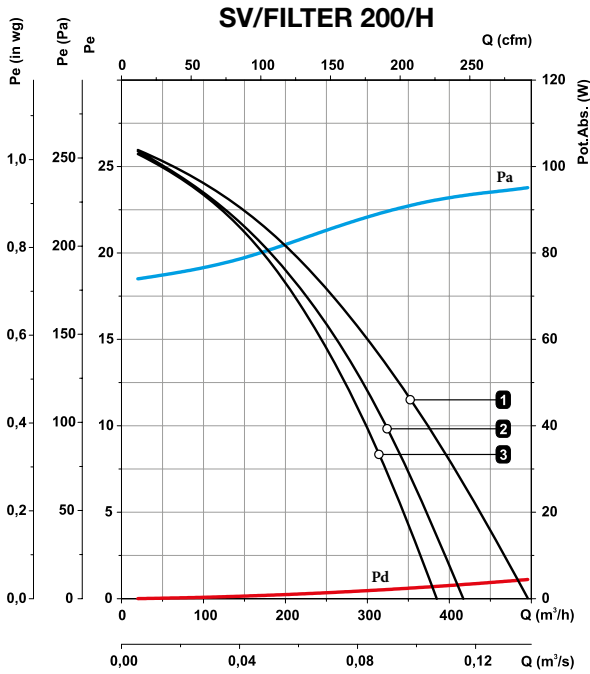

Characteristic curves

Equipment curve according to built-in filters **1** G4+F6 **2** F6+F8 **3** F7+F9

Static pressure

Dynamic pressure

Absorbed power

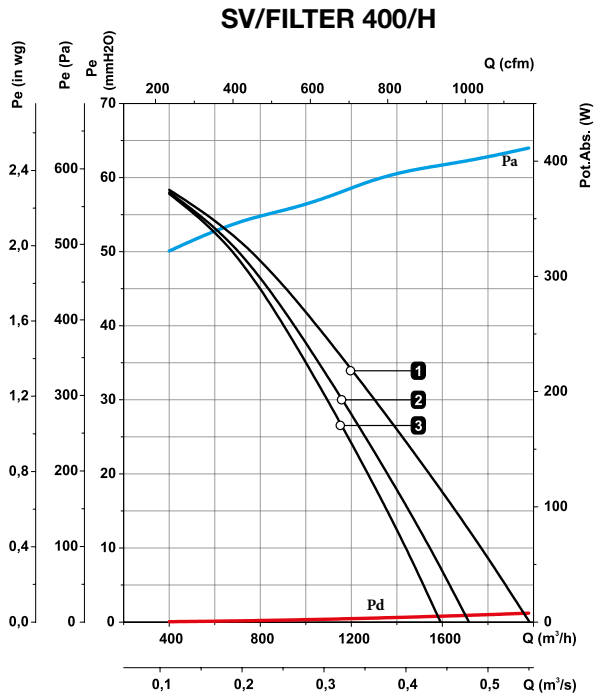

Accessories

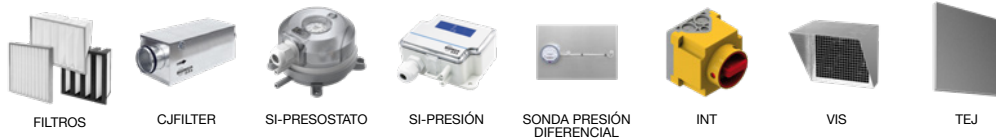

SV/FILTER-CG

Air purifying units with UVc germicidal chamber in line for ducts and different stages of filtration



F7 + F9

Characteristics:

- Built-in UVc germicidal chamber.
- Acoustic casing covered with sound absorbing material.
- Standardised inlet and outlet flanges allowing for easy installation in ducts.
- F7 + F9 filters.
- Easy access inspection and cleaning hatch.

Construction:

- Galvanized steel sheet casing.
- Backward curved impellers, except for models 125 and 150 which have multi-bladed impellers. Supplied with four support feet for easy mounting.
- Access doors to facilitate maintenance and cleaning.

Motor:

- External rotor motors with built-in thermal protector, class F, with ball bearings, IP54 protection.
- Single-phase 230 V 50/60 Hz adjustable.
- Maximum temperature of air to be carried: +50 °C.

Finish:

- Anti-corrosive finish in polyester resin, polymerised at 190 °C, after degreasing with phosphate-free nanotechnology treatment.

On request:

- Other filtration stages: G4 + F6 or F6 + F8.
- Automatic control system.

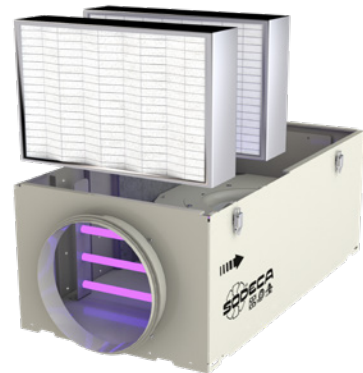

Application example

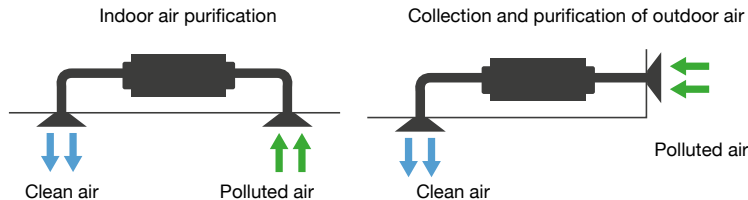

Order code

SV/FILTER-CG - 200/H - F7+F9

SV/FILTER-CG: Air purifying units with UVc germicidal chamber in line for ducts and different stages of filtration

Impeller diameter in mm

Filters F7+F9

Filter characteristics

Filters	EN 779 Em	EN 1822	ISO 16890			
			ISO ePM ₁	ISO ePM _{2.5}	ISO ePM ₁₀	ISO COARSE
G4	90%	-	-	-	-	>90%
F7	90%	-	>50%	>65-95%	>85%	-
F9	95%	-	>80%	>95%	>95%	-
HEPA H14	-	>99.995%	-	-	-	-

Technical characteristics

Model	Recommended effective working area ¹ (m ²)	Speed (r/min)	Maximum admissible current (A) 230V	Standard Filters (F7+F9)	Maximum flow rate (m ³ /h)		Approx. weight (Kg)
					On request Filters (G4+F6)	On request Filters (F6+F8)	
SV/FILTER-CG-200/H	40	1240	0.65	375	590	430	15.4
SV/FILTER-CG-250/H	60	2380	1.25	525	660	560	18.1
SV/FILTER-CG-315/H	80	1330	0.85	790	1035	850	26.7
SV/FILTER-CG-350/H	120	1280	0.95	1180	1550	1270	36.6
SV/FILTER-CG-400/H	160	1330	1.8	1600	2050	1720	46.7

Recommended area with F7 + F9 filters, and with a 3-meter high room.

Technical characteristics of the UVC germicidal chamber

These purification units integrate a germicidal chamber, built with UVC ultraviolet lamps in a 256 nm spectrum, a wave width indicated to inactivate a wide variety of microorganisms by absorbing short wavelength energy through DNA and RNA.

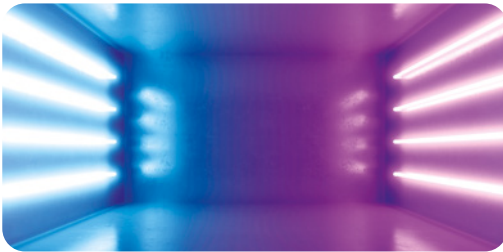

Model	Number of lamps	Total electrical power(W)	Total Uvc radiation power (W)	Radiation dose (mJ/cm ²) *
SV/FILTER-CG-200/H	4	36	11.2	5.3
SV/FILTER-CG-250/H	4	36	11.2	4.7
SV/FILTER-CG-315/H	4	102	28	8.4
SV/FILTER-CG-350/H	4	102	28	6.2
SV/FILTER-CG-400/H	4	102	28	5.1

*Minimum dose calculated based on flow with filters: F7+F9



Erp. (Energy Related Products)

Information on Directive 2009/125/EC can be downloaded from the SODECA website or the QuickFan selector programme.

Dimensions mm

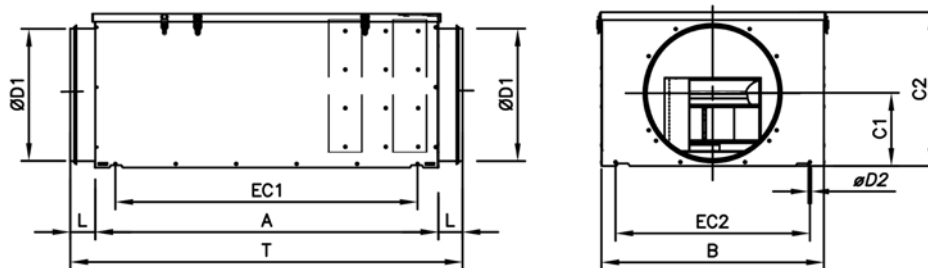

	A	B	C1	C2	ØD1	ØD2	EC1	EC2	L	T
SV/FILTER-CG-200/H	775	395	117	273	200	5.4	725	345	36	847
SV/FILTER-CG-250/H	775	420	140	293	250	5.4	725	345	43	861
SV/FILTER-CG-315/H	860	520	170	376	315	6.1	809	469	43	946
SV/FILTER-CG-350/H	960	610	200	410	355	6.1	909	564	43	1046
SV/FILTER-CG-400/H	1035	670	219	462	400	6.1	984	624	63	1161

Characteristic curves

Equipment curve with standard built-in filters

3 F7+F9

Equipment curve with alternative filters

1 G4+F6

2 F6+F8

Static pressure

Dynamic pressure

Absorbed power

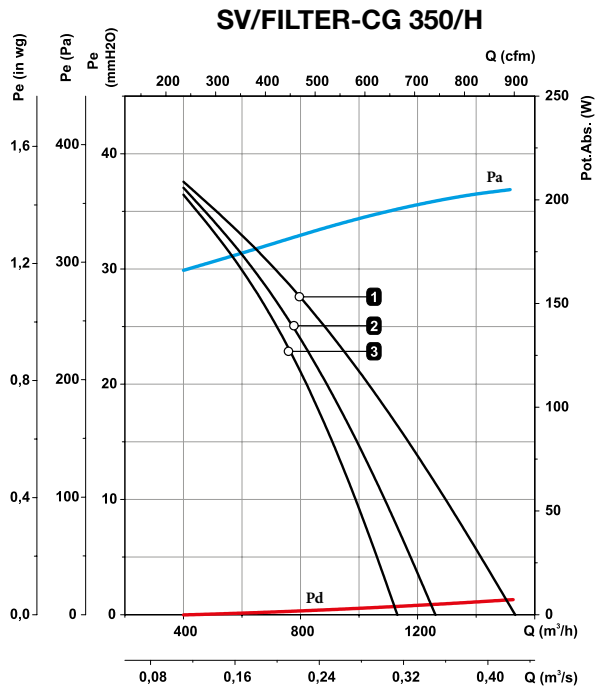
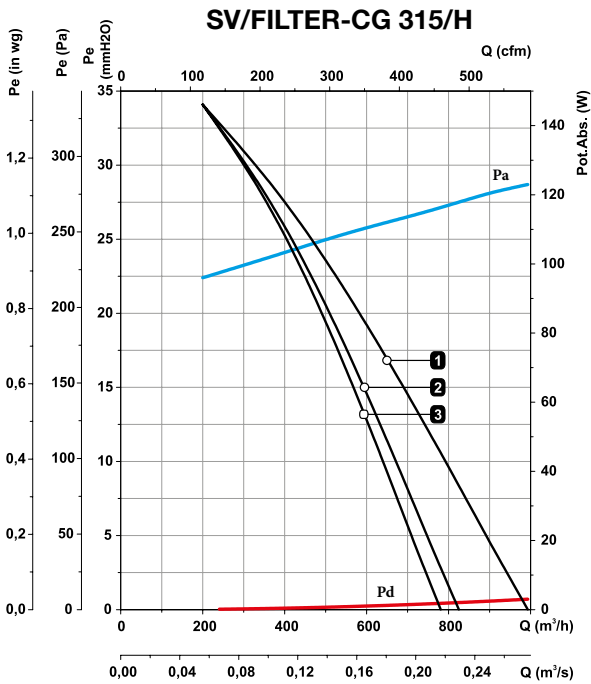
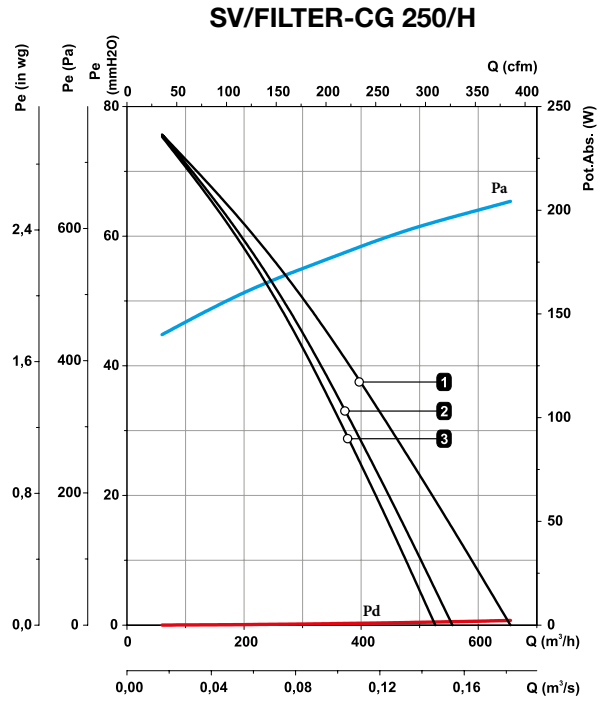
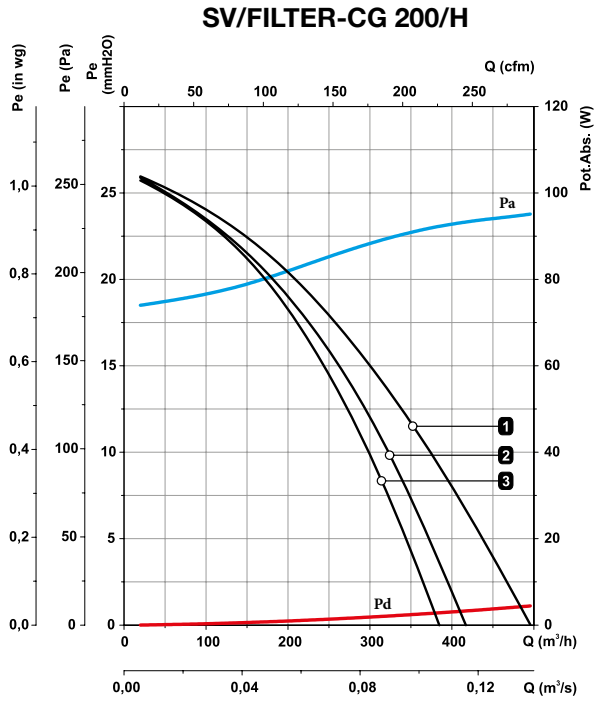

Characteristic curves

Equipment curve with standard built-in filters

3 F7+F9

Equipment curve with alternative filters

1 G4+F6

2 F6+F8

Static pressure

Dynamic pressure

Absorbed power

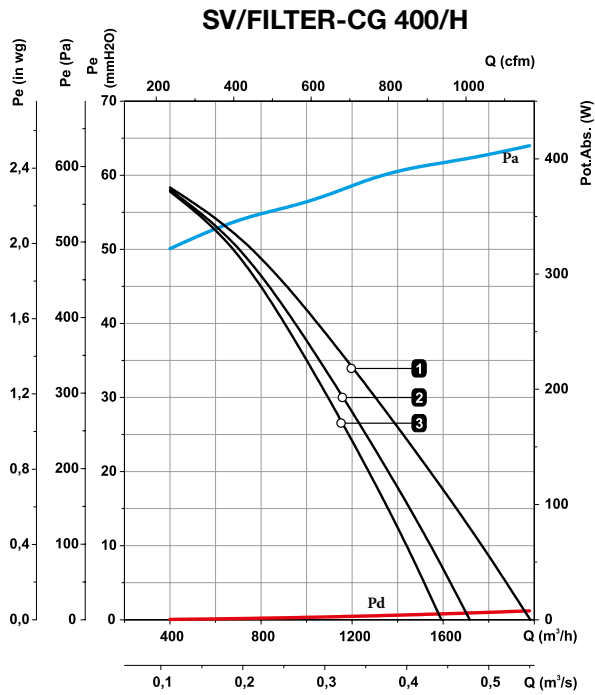

Accessories



SV/FILTER/EC

Filtration units for circular ducts and EC Technology motor



DIFFERENT
FILTRATION STAGES
DEPENDING ON
MODEL:



Filtration units for circular ducts, with low noise level, different filtration stage options and EC Technology motor.

Fan:

- Acoustic casing covered with sound absorbing material.
- Standardised inlet and outlet flanges with watertight joints.
- F6 + F8, F7 + F9 and G4 + CA, filters according to model.
- Easy access inspection and cleaning cover with manual fasteners.
- Centrifugal fan with a backward curved impeller.
- Integrated support into the box which facilitates its assembly.
- Linear airflow direction.
- 3 pressure taps for individual control of the two filtration stages.

- Installation in any position.
- With guide slot for 25 mm prefilter.
- More efficient filter anti-by-pass adjustment.

Motor:

- High efficiency external rotor EC Technology motors, adjustable via 0-10 V signal.
- Single-phase 220-240 V 50/60 Hz, IP54 protection.
- Maximum temperature of air to be carried: -25 °C +60 °C.

Finish:

- Anti-corrosive in galvanized steel sheet.

Order code

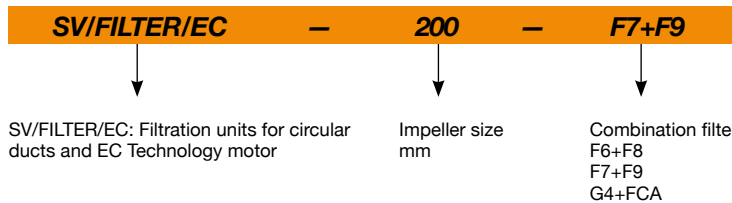

Technical characteristics

Model	Speed (r/min)	Maximum admissible current (A) 230V	Maximum power (W)	Maximum flow rate (m³/h)			Sound pressure level at 50% of max. speed* dB (A)	Approx. weight (Kg)	According ErP
				F6+F8	F7+F9	G4+CA			
SV/FILTER/EC-150	3540	0.97	120	553	527	454	38	14	2018
SV/FILTER/EC-200	3265	1.35	176	768	734	641	45	17	2018
SV/FILTER/EC-250	2850	1.35	180	913	850	744	49	19	2018
SV/FILTER/EC-315	2320	2.00	450	1917	1806	1507	52	34	2018
SV/FILTER/EC-350	1460	1.45	190	1532	1382	1061	42	39	2018
SV/FILTER/EC-400	1700	4.70	750	3279	3024	2428	52	66	2018

* Irradiated sound pressure level in dB(A) at a distance of 1 m.



Erp. (Energy Related Products)

Information on Directive 2009/125/EC can be downloaded from the SODECA website or the QuickFan selector programme.

Acoustic characteristics

Sound power spectrum Lw(A) in dB(A) per Hz frequency band
Irradiated values at maximum speed and medium flow rate.

	63	125	250	500	1000	2000	4000	8000
SV/FILTER/EC-150	56	52	56	54	48	43	39	33
SV/FILTER/EC-200	63	59	63	61	55	50	46	40
SV/FILTER/EC-250	67	63	67	65	59	54	50	44
SV/FILTER/EC-315	69	66	70	67	61	57	53	47
SV/FILTER/EC-350	59	56	60	58	53	50	47	41
SV/FILTER/EC-400	70	66	70	68	62	57	53	47

Dimensions mm

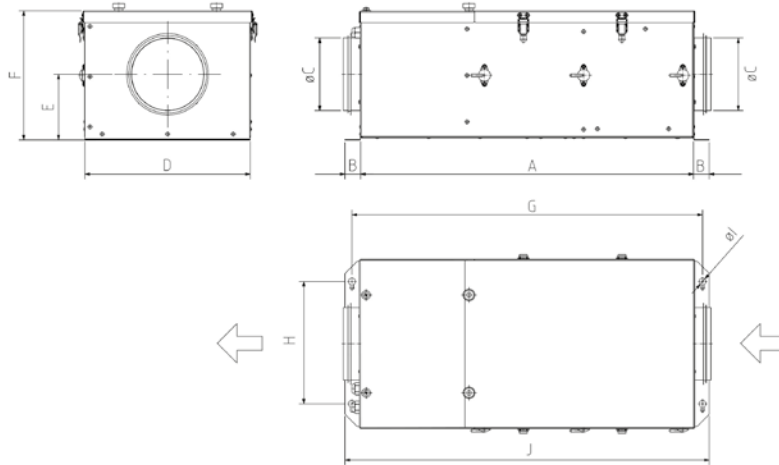

	A	B	ØC	D	E	F	G	H	ØI	J
SV/FILTER/EC-150	680	34.5	150	340	134.5	262.5	715	250	14	750
SV/FILTER/EC-200	700	38.5	200	395	152	300	735	290	14	780
SV/FILTER/EC-250	750	48.5	250	420	162	323	785	335	14	850
SV/FILTER/EC-315	830	58	310	520	202	404	865	435	14	950
SV/FILTER/EC-350	920	56	350	610	223.5	446	955	525	14	1030
SV/FILTER/EC-400	1000	60.5	400	670	251.5	505.5	1030	575	14	1120

Accessories



FILTRATION AND DISINFECTION UNITS

Characteristic curves

Q= Flow rate in m³/h, m³/s and cfm

Pe= Static pressure in mm H₂O, Pa and inwg

SV/FILTER/EC 150

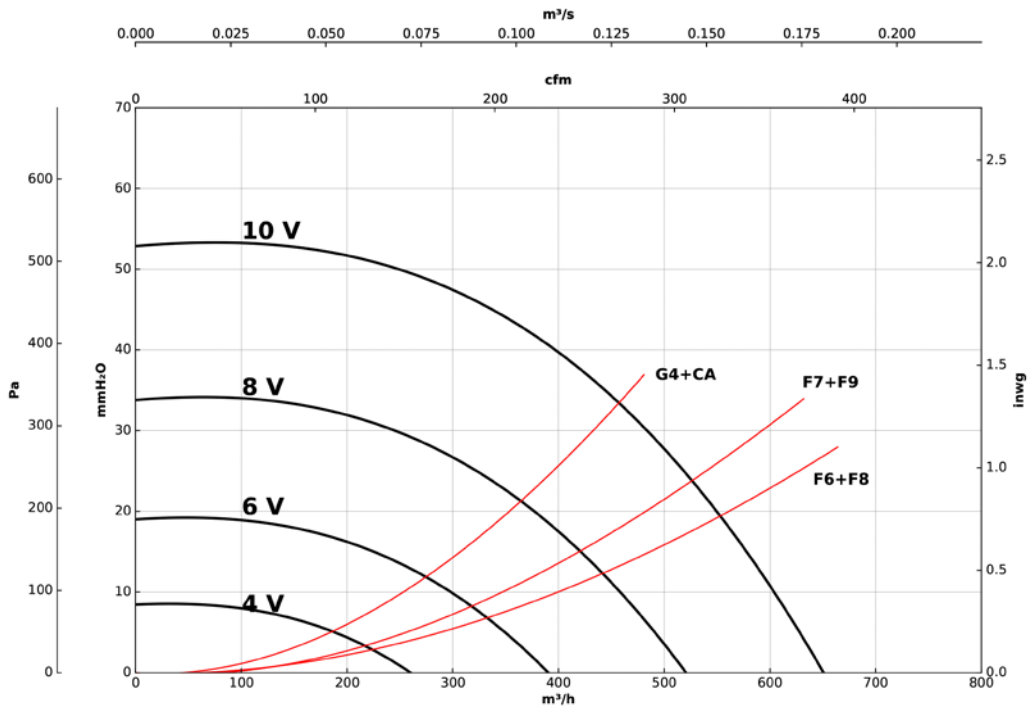

SV/FILTER/EC 200

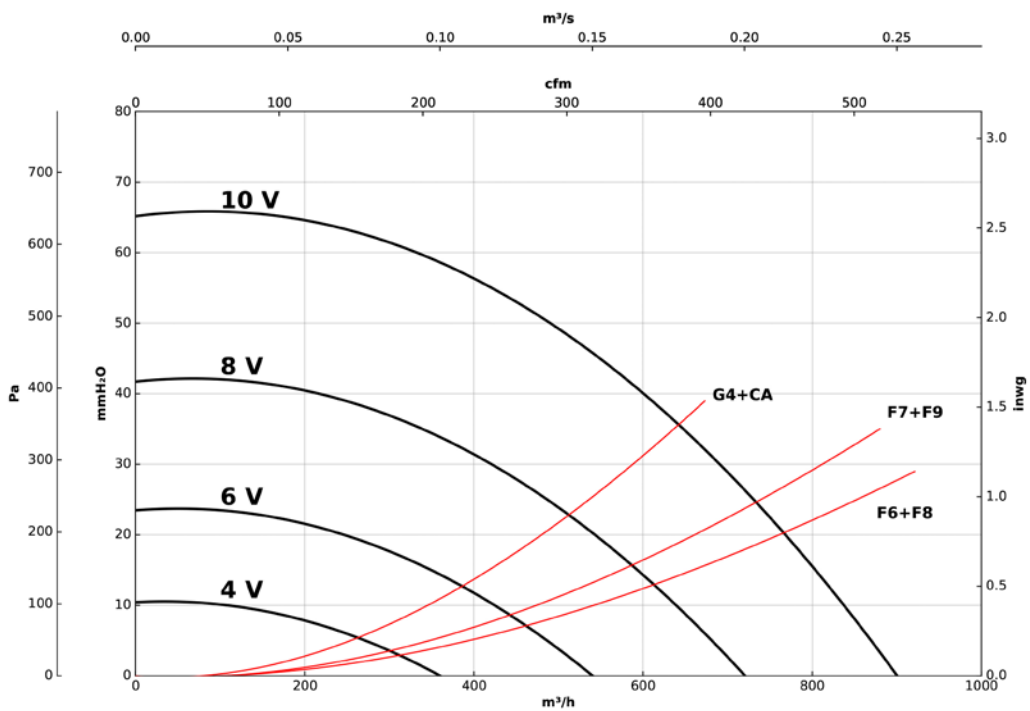

Characteristic curves

Q= Flow rate in m³/h, m³/s and cfm

Pe= Static pressure in mm H₂O, Pa and inwg

SV/FILTER/EC 250

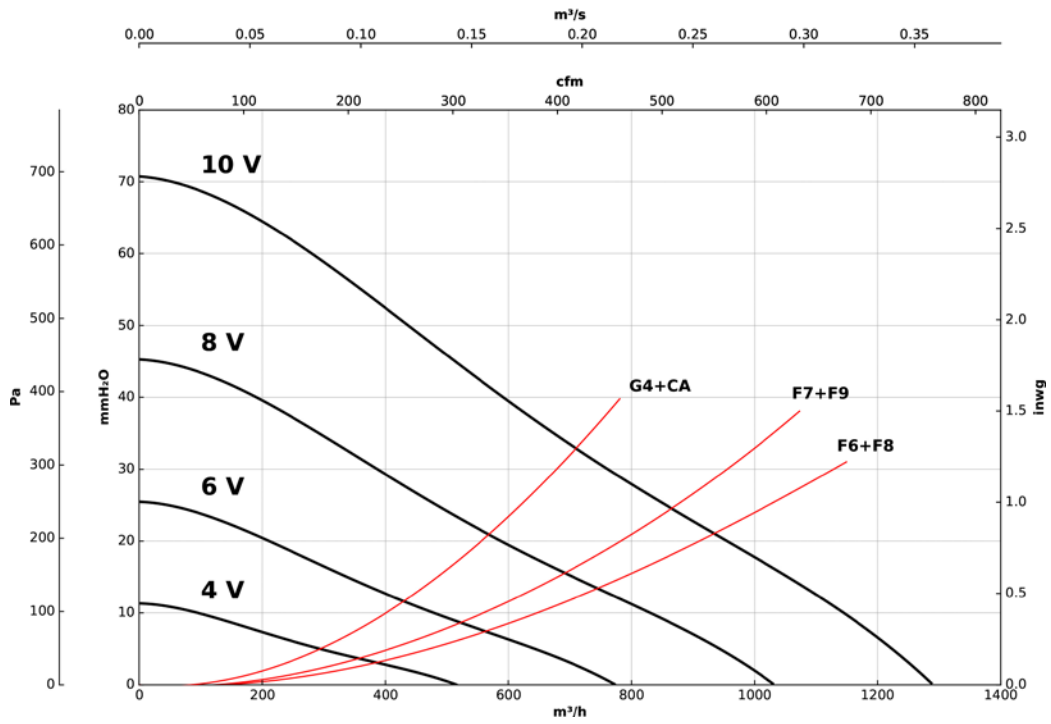

SV/FILTER/EC 315

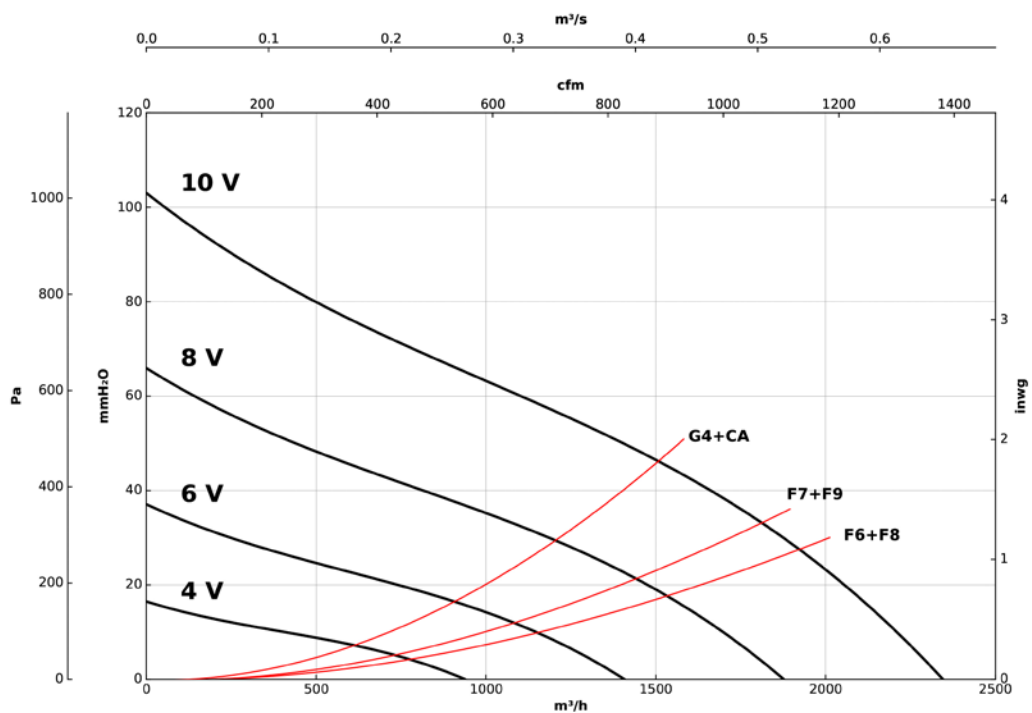

FILTRATION AND
DISINFECTION UNITS

Characteristic curves

Q= Flow rate in m³/h, m³/s and cfm

Pe= Static pressure in mm H₂O, Pa and inwg

SV/FILTER/EC 350

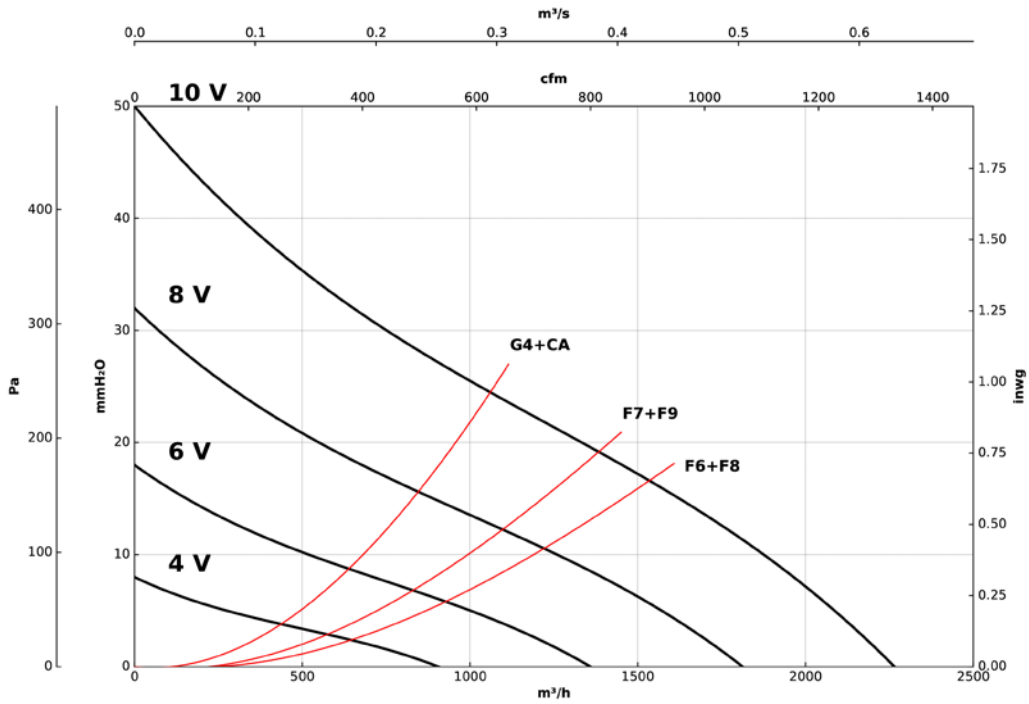

SV/FILTER/EC 400

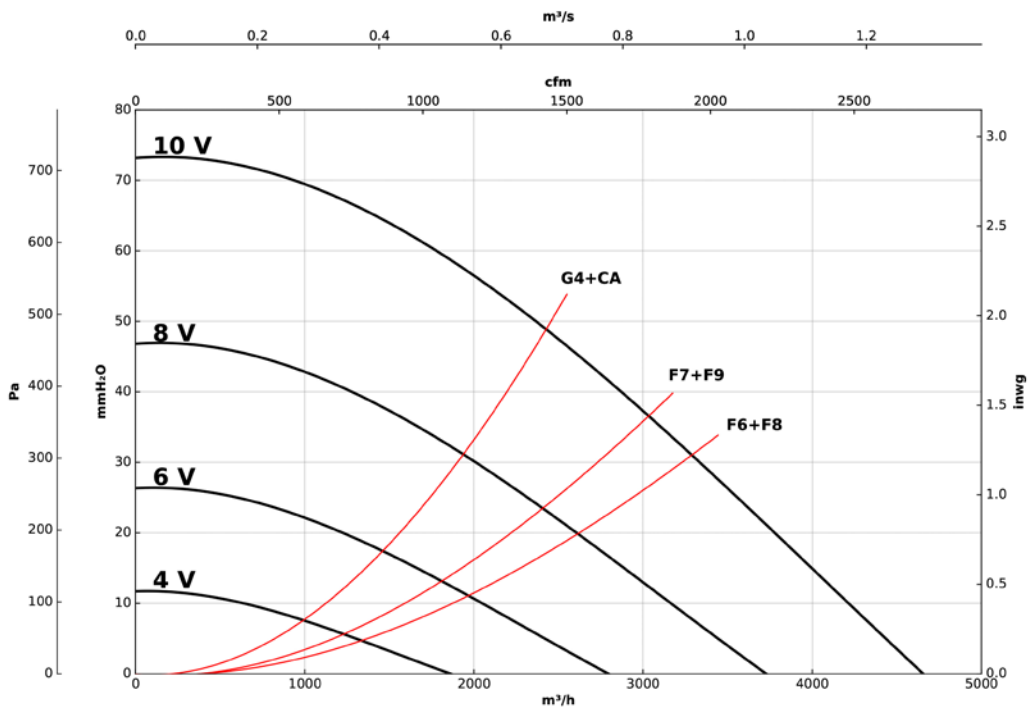

SV/HEPA/EC

HEPA filtration units for circular ducts and EC Technology motor



HEPA filtration units for circular ducts, with low noise level and EC Technology motor.

Fan:

- Acoustic casing covered with sound absorbing material.
- Standardised inlet and outlet flanges with watertight joints.
- F7 + H14 filters.
- Easy access inspection and cleaning cover with manual fasteners.
- Centrifugal fan with a backward curved impeller.
- Integrated support into the box which facilitates its assembly.
- Linear airflow direction.
- 3 pressure taps for individual control of the two filtration stages.

- Installation in any position.
- With guide slot for 25 mm prefilter.
- More efficient filter anti-by-pass adjustment.

Motor:

- High efficiency external rotor EC Technology motors, adjustable via 0-10 V signal.
- Single-phase 220-240 V 50/60 Hz, IP54 protection.
- Maximum temperature of air to be carried: -25 °C +60 °C.

Finish:

- Anti-corrosive in galvanized steel sheet.

Order code

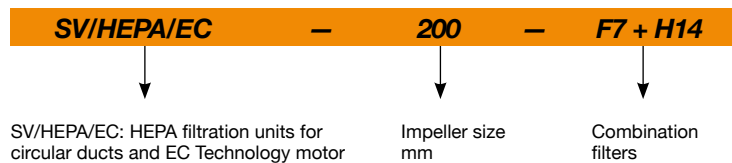

Technical characteristics

Model	Speed	Maximum admissible current (A)	Maximum power	Maximum flow rate	Sound pressure level at 50% of max. speed*	Approx. weight	According ErP
	(r/min)	230V	(W)	(m ³ /h)	dB (A)	(Kg)	
SV/HEPA/EC-150	3540	0.97	120	375	38	14	2018
SV/HEPA/EC-200	3265	1.35	176	544	45	17	2018
SV/HEPA/EC-250	2850	1.35	180	582	49	19	2018
SV/HEPA/EC-315	2320	2.00	450	1223	52	34	2018
SV/HEPA/EC-350	1460	1.45	190	827	42	39	2018
SV/HEPA/EC-400	1700	4.70	750	1918	52	66	2018

* Irradiated sound pressure level in dB(A) at a distance of 1 m.



Erp. (Energy Related Products)

Information on Directive 2009/125/EC can be downloaded from the SODECA website or the QuickFan selector programme.

Acoustic characteristics

Sound power spectrum Lw(A) in dB(A) per Hz frequency band
Irradiated values at maximum speed and medium flow rate.

	63	125	250	500	1000	2000	4000	8000
SV/HEPA/EC-150	56	52	56	54	48	43	39	33
SV/HEPA/EC-200	63	59	63	61	55	50	46	40
SV/HEPA/EC-250	67	63	67	65	59	54	50	44
SV/HEPA/EC-315	69	66	70	67	61	57	53	47
SV/HEPA/EC-350	59	56	60	58	53	50	47	41
SV/HEPA/EC-400	70	66	70	68	62	57	53	47

Dimensions mm

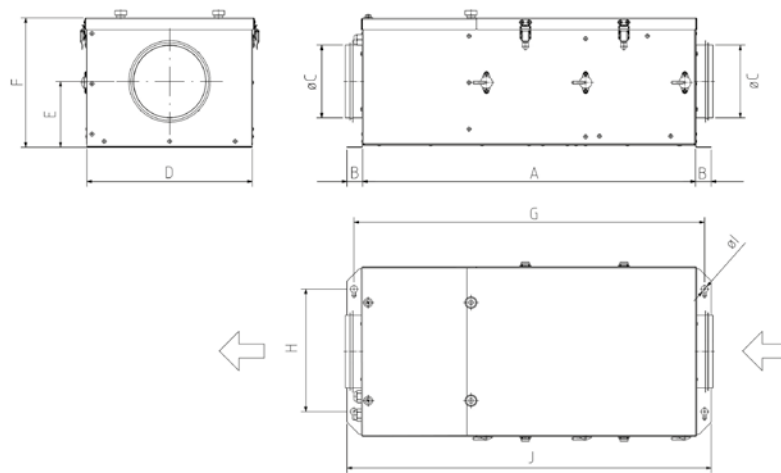

	A	B	ØC	D	E	F	G	H	ØI	J
SV/HEPA/EC-150	680	34.5	150	340	134.5	262.5	715	250	14	750
SV/HEPA/EC-200	700	38.5	200	395	152	300	735	290	14	780
SV/HEPA/EC-250	750	48.5	250	420	162	323	785	335	14	850
SV/HEPA/EC-315	830	58	310	520	202	404	865	435	14	950
SV/HEPA/EC-350	920	56	350	610	223.5	446	955	525	14	1030
SV/HEPA/EC-400	1000	60.5	400	670	251.5	505.5	1030	575	14	1120

Accessories



Characteristic curves

Q= Flow rate in m³/h, m³/s and cfm

Pe= Static pressure in mm H₂O, Pa and inwg

SV/HEPA/EC 150

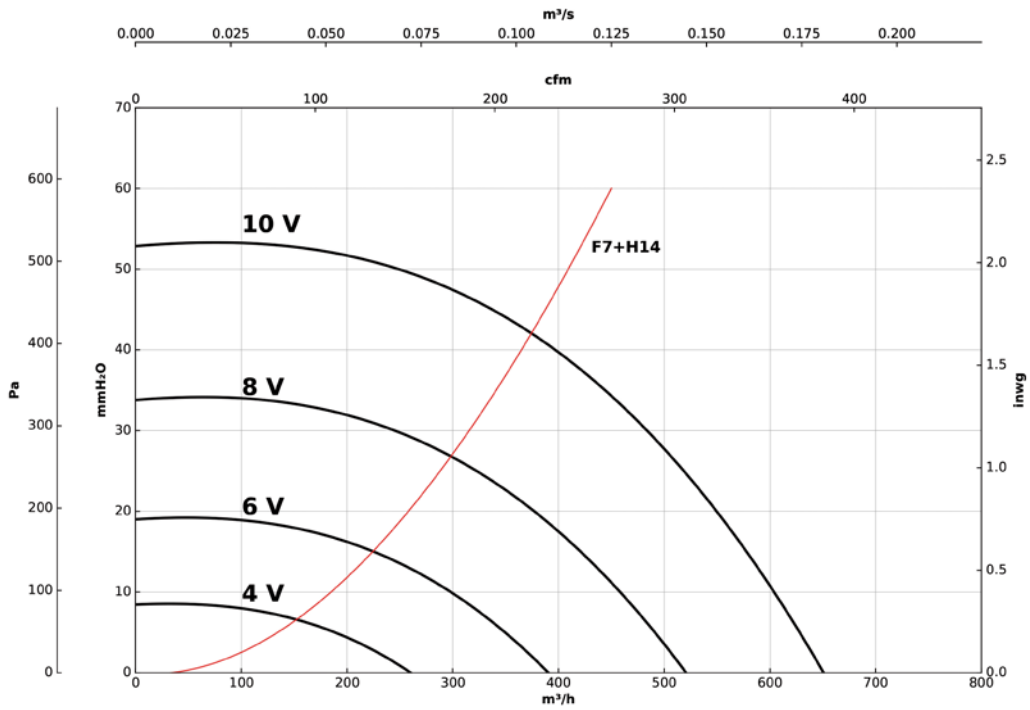

SV/HEPA/EC 200

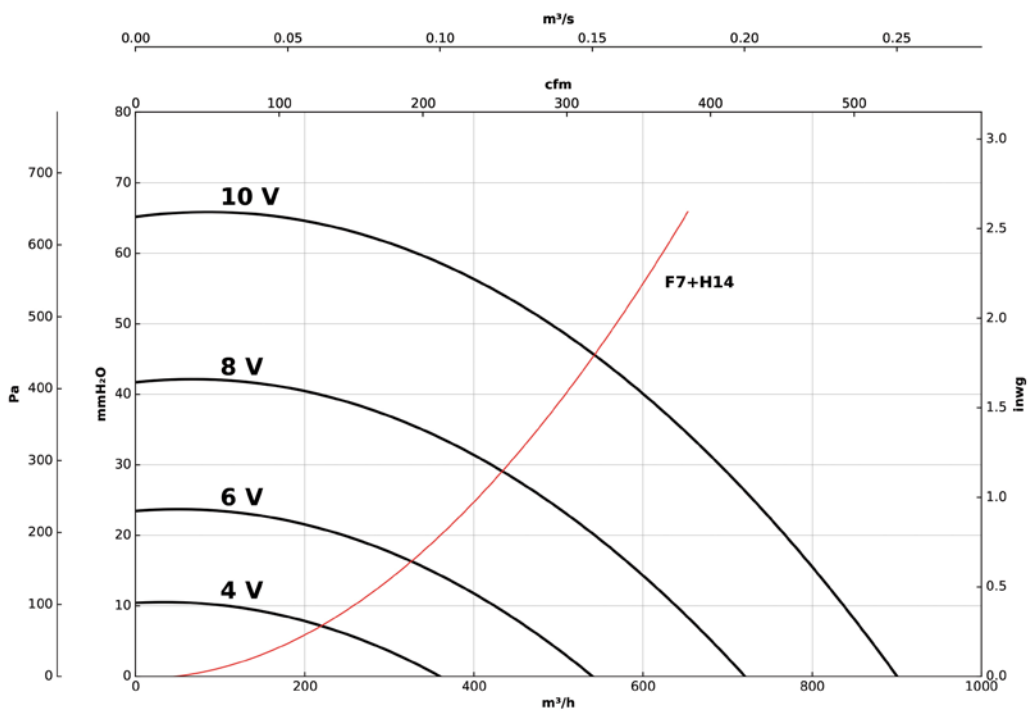

FILTRATION AND DISINFECTION UNITS

Characteristic curves

Q= Flow rate in m³/h, m³/s and cfm

Pe= Static pressure in mm H₂O, Pa and inwg

SV/HEPA/EC 250

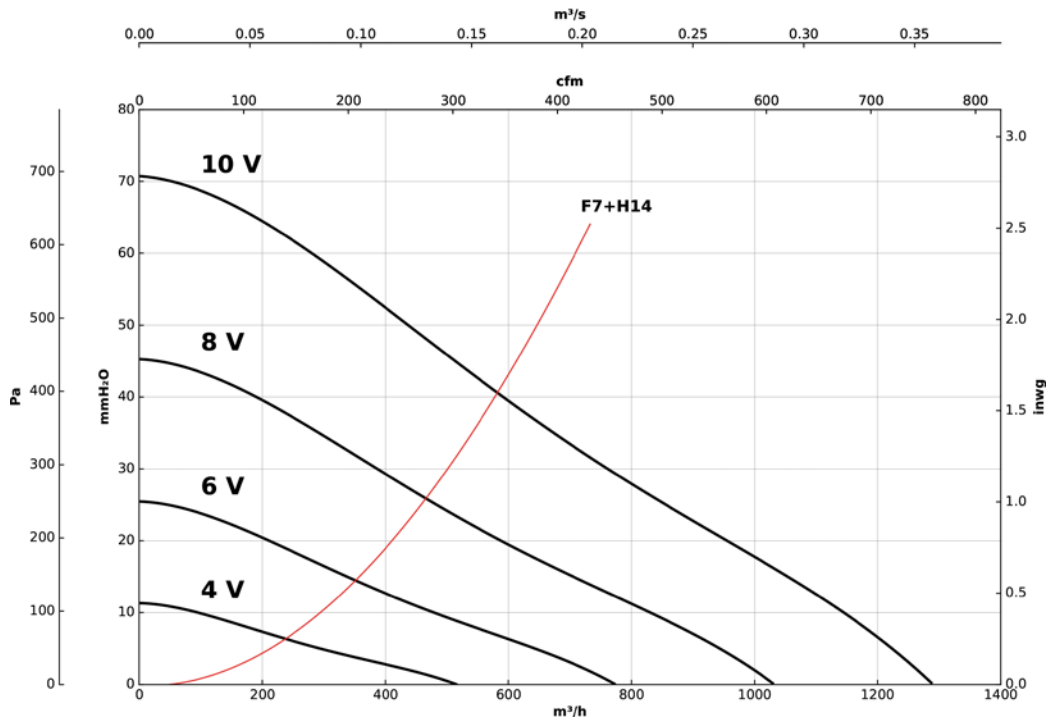

SV/HEPA/EC 315

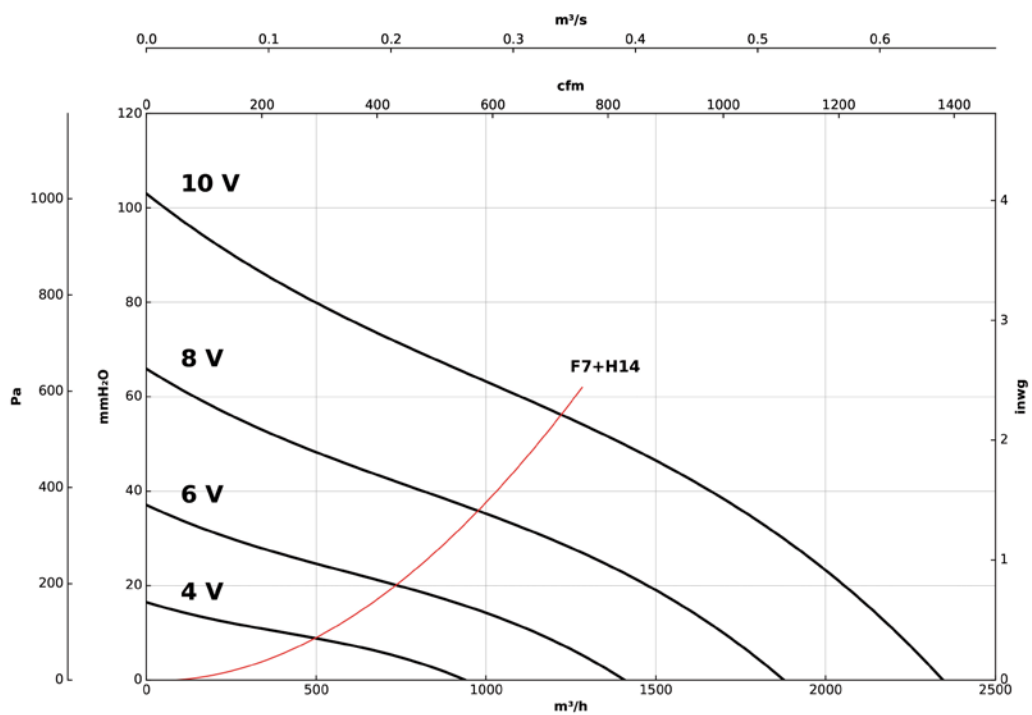

Characteristic curves

Q= Flow rate in m³/h, m³/s and cfm

Pe= Static pressure in mm H₂O, Pa and inwg

SV/HEPA/EC 350

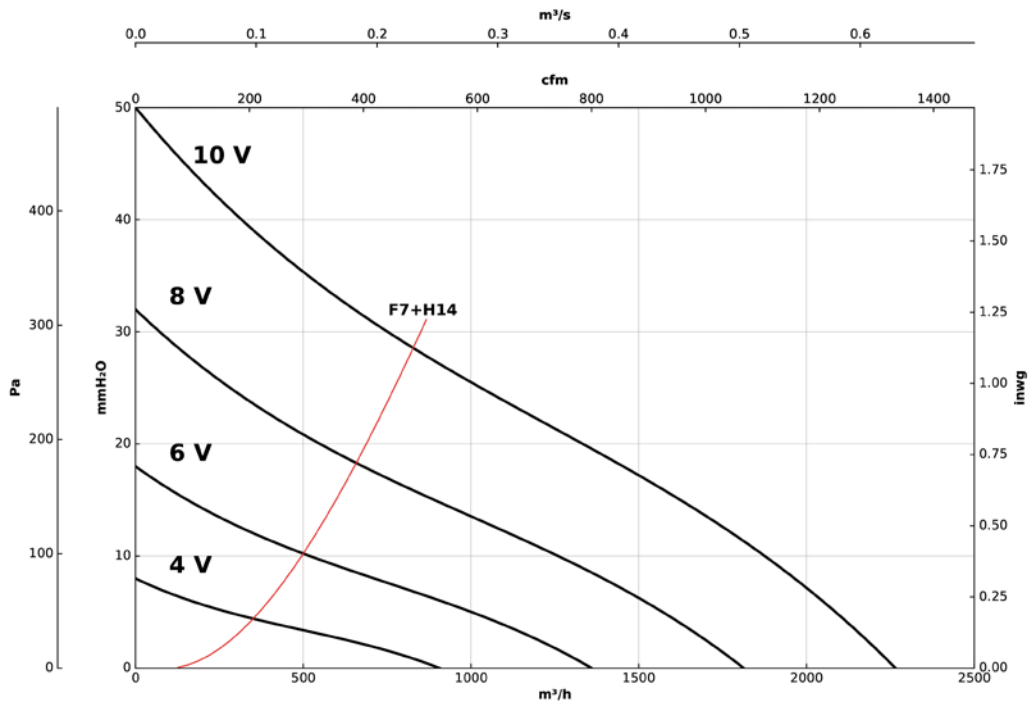

SV/HEPA/EC 400

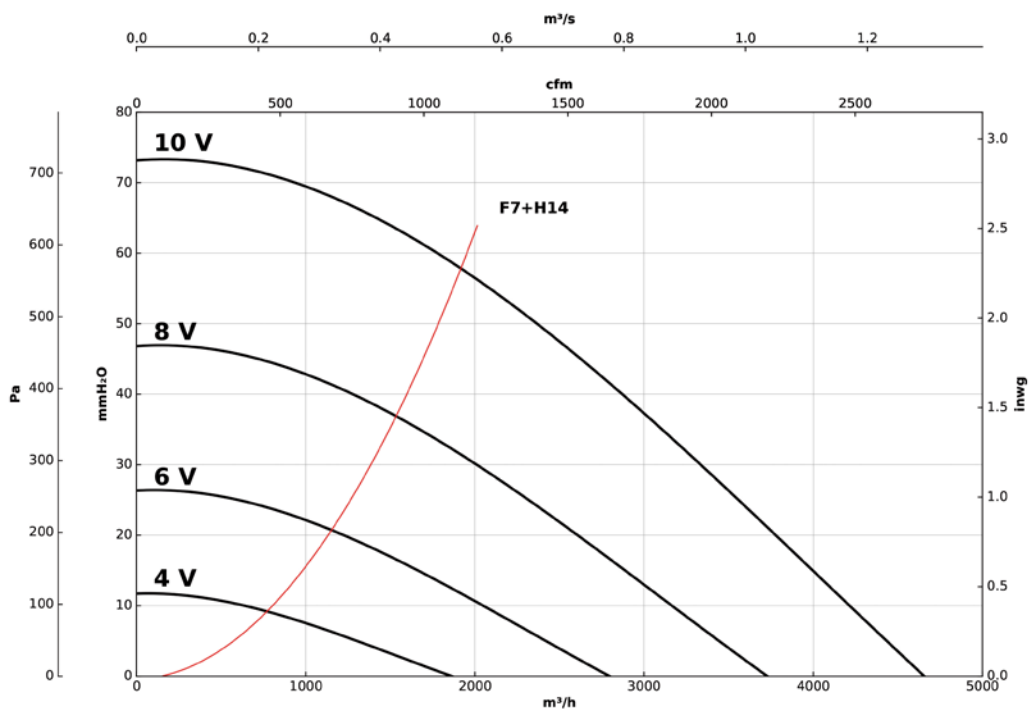

FILTRATION AND DISINFECTION UNITS

UPT

Ceiling units for purifying and disinfecting air using HEPA H14 filtration

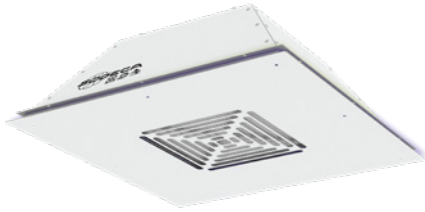
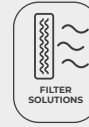

Ceiling units for purifying and disinfecting air, equipped with HEPA H14 filters and Plug Fans, with AC or EC Technology motors, depending on model, and with optional UVc germicidal chambers. These units have been especially designed to be installed above false ceilings in high occupancy areas.

Characteristics:

- Structure designed for installation above false ceilings.
- Washable pre-filter.
- HEPA type filters with a filtration efficiency of 99.99%.
- UVc germicidal chamber, depending on model.
- Plug Fan with AC or EC Technology, depending on model.
- Backward curved impeller.
- Inspection cover for filter maintenance and replacement.
- Low noise levels.

Motor:

- EC version: High efficiency external rotor EC Technology motors, adjustable via 0-10 V signal.
- AC version: External rotor motors with built-in thermal guard, class F, with ball bearings, IP54 protection.

Finish:

- Anti-corrosive finish in polyester resin, polymerised at 190 °C, after degreasing with phosphate-free nanotechnology treatment.
- RAL 9003 supplied as standard.

On request:

- Any other RAL can be supplied.

Order code

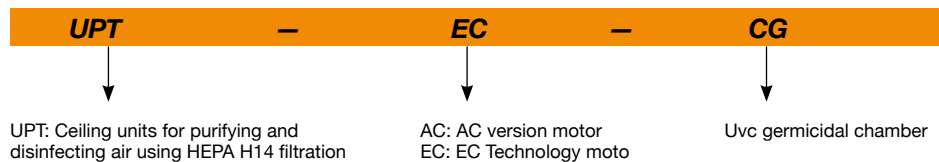

Technical characteristics

Model	Maximum flow rate (m ³ /h)	Recommended effective working area ¹ (m ²)	Speed (r/min)	Maximum power (W)	Power supply	Sound pressure level at 50% of max speed.* dB (A)	Approx. weight (Kg)
UPT AC	150	20	1410	60	200-240V 50/60Hz 1Ph	33	10
UPT EC	350	45	2440	120	200-240V 50/60Hz 1Ph	45	10
UPT AC-CG	150	20	1410	60	200-240V 50/60Hz 1Ph	33	10
UPT EC-CG	350	45	2440	120	200-240V 50/60Hz 1Ph	45	10

¹Recommended effective working area with a 3-meter-high premises.

*Irradiated sound pressure level in dB(A) at a distance of 3 m.

Technical characteristics of the UVC germicidal chamber

According to the model, these purification units can integrate a germicidal chamber, built with UVC ultraviolet lamps in a 256 nm spectrum, a wave width indicated to inactivate a wide variety of microorganisms by absorbing short wavelength energy through DNA and RNA.

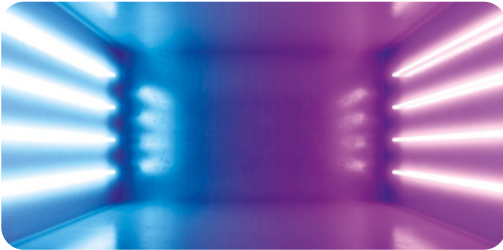

Model	Number of lamps	Total electrical power (W)	Total Uvc radiation power (W)	Radiation dose (mJ/cm ²)
UPT AC-CG	4	44	11.2	12.4
UPT EC-CG	4	44	11.2	5.3

Dimensions mm

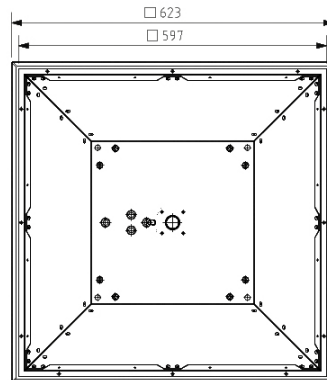
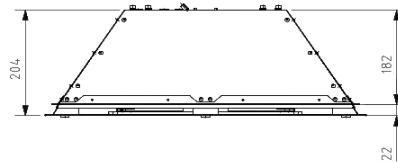

Accessories



CAP/EC



SI-PM2.5+VOC



SI-CO2+VOC



MICA-LITE/W



RAC WIFI

Recessed WiFi controller for AC motors up to 300 W with connections for auxiliary equipment

This controller allows fan speed adjustment and allows the germicidal chamber lamps to be turned on or off. Additionally, it is equipped with WiFi connectivity for remote operation, which also allows function and time programming via the Smart Life application.

CJK/FILTER/EC

Air purifying units for circular ducts, 25 mm acoustic casing, EC Technology motor

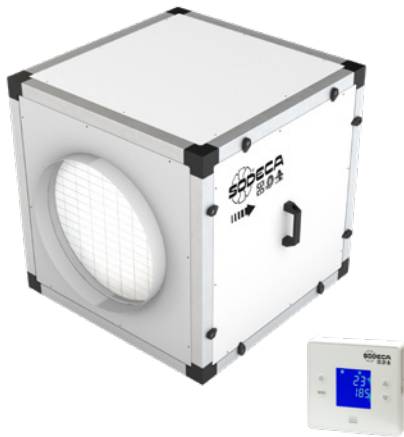
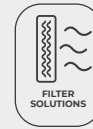

Characteristics:

- 40 mm aluminium profile structure.
- Covers with a high quality, 25 mm thick acoustic casing made of prefinished sheet.
- Backward curved impeller.
- Standardised inlet and outlet flanges allowing for easy installation in ducts.
- Filtration stages, depending on model:
 - F7 + F9.
 - F7 + HEPA H14.
- Active carbon filter for odour removal.
- Adjustable filter change alarm.
- Germicidal chamber with UVC ultraviolet lamps (256 nm), depending on model.
- Inspection cover for filter maintenance and replacement.
- Air inlet nozzle with diffusers that increase the efficiency of the fan.

Motor:

- High efficiency external rotor EC Technology motors, adjustable via 0-10 V signal.
- Single-phase 200-240 V 50/60 Hz and three-phase 380-480 V 50/60 Hz.
- Maximum temperature of air to be carried: -25 °C +60 °C.

Finish:

- Aluminium profile and prefinished sheet steel structure with 25 mm thick thermal and acoustic insulation panels.

On request:

- Particle sensor for automatic control.

Order code

CJK/FILTER/EC	—	220	—	F7+F9	—	CG
↓		↓		↓		↓
CJK/FILTER/EC: Air purifying units for circular ducts, 25 mm acoustic casing, EC Technology motor		Impeller diameter in mm		Filter F7 + F9 Filter F7 + HEPA H14		Uvc germicidal chamber

Filter characteristics

Filters	EN 779	EN 1822	ISO 16890			
	Em		ISO ePM ₁	ISO ePM _{2,5}	ISO ePM ₁₀	ISO COARSE
F7	90%	-	>50%	>65-95%	>85%	-
F9	95%	-	>80%	>95%	>95%	-
HEPA H14	-	>99.995%	-	-	-	-

Technical characteristics

Model	Recommended effective working area ¹ (m ²)		Speed (r/min)	Maximum power (W)	Power supply	Sound pressure level at 50% of max speed. ² (dB (A))	Maximum flow rate (m ³ /h)		Approx. weight (Kg)
	Filters (F7+F9)	Filters (F7+H14)					Filters (F7+F9)	Filters (F7+H14)	
CJK/FILTER/EC-220	50	-	3265	176	200-240V 50/60Hz 1Ph	48	420	-	32
CJK/FILTER/EC-250	60	-	2850	180	200-240V 50/60Hz 1Ph	49	500	-	33
CJK/FILTER/EC-310	65	55	1920	175	200-240V 50/60Hz 1Ph	47	550	450	34
CJK/FILTER/EC-400	190	155	1550	460	200-240V 50/60Hz 1Ph	47	1600	1300	68
CJK/FILTER/EC-500	270	230	1250	1150	380-480V 50/60Hz 3Ph	51	2250	1950	118

¹Recommended effective working area with a 3-meter-high premises.

² Irradiated sound pressure level in dB(A) at a distance of 3 m.

Technical characteristics of the UVC germicidal chamber

According to the model, these purification units can integrate a germicidal chamber, built with UVC ultraviolet lamps in a 256 nm spectrum, a wave width indicated to inactivate a wide variety of microorganisms by absorbing short wavelength energy through DNA and RNA.

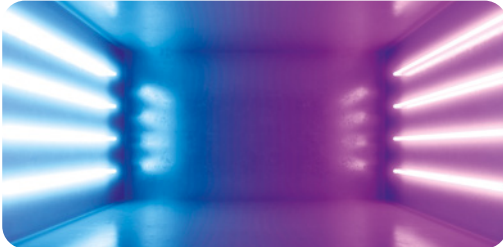

Model	Number of lamps	Total electrical power (W)	Total Uvc radiation power (W)	Radiation dose (mJ/cm ²)*
CJK/FILTER/EC-220	6	54	16.8	7.2
CJK/FILTER/EC-250	6	54	16.8	6.0
CJK/FILTER/EC-310	6	54	16.8	6.7
CJK/FILTER/EC-400	4	102	28	5.4
CJK/FILTER/EC-500	6	153	42	7.0

*Minimum dose calculated based on the maximum flow rate.



Erp. (Energy Related Products)

Information on Directive 2009/125/EC can be downloaded from the SODECA website or the QuickFan selector programme.

Acoustic characteristics

Sound power spectrum Lw(A) in dB(A) per Hz frequency band
Irradiated values at maximum speed and medium flow rate.

	63	125	250	500	1000	2000	4000	8000
CJK/FILTER/EC-220	63	65	63	58	55	51	45	35
CJK/FILTER/EC-250	64	66	64	59	56	52	46	36
CJK/FILTER/EC-310	62	64	62	57	54	50	44	34
CJK/FILTER/EC-400	66	61	56	53	54	49	43	32
CJK/FILTER/EC-500	69	65	60	61	61	58	59	54

Dimensions mm

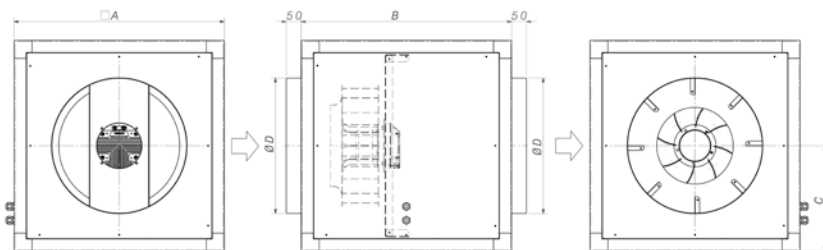

	A	B	C	ØD
CJK/FILTER/EC-220	500	500	250	315
CJK/FILTER/EC-250	500	500	250	355
CJK/FILTER/EC-310	500	500	250	355
CJK/FILTER/EC-400	700	700	350	450
CJK/FILTER/EC-500	900	900	450	500

Accessories



Characteristic curves

Q= Flow rate in m³/h, m³/s and cfm

Pe= Static pressure in mm H₂O, Pa and inwg

CJK/FILTER/EC -220

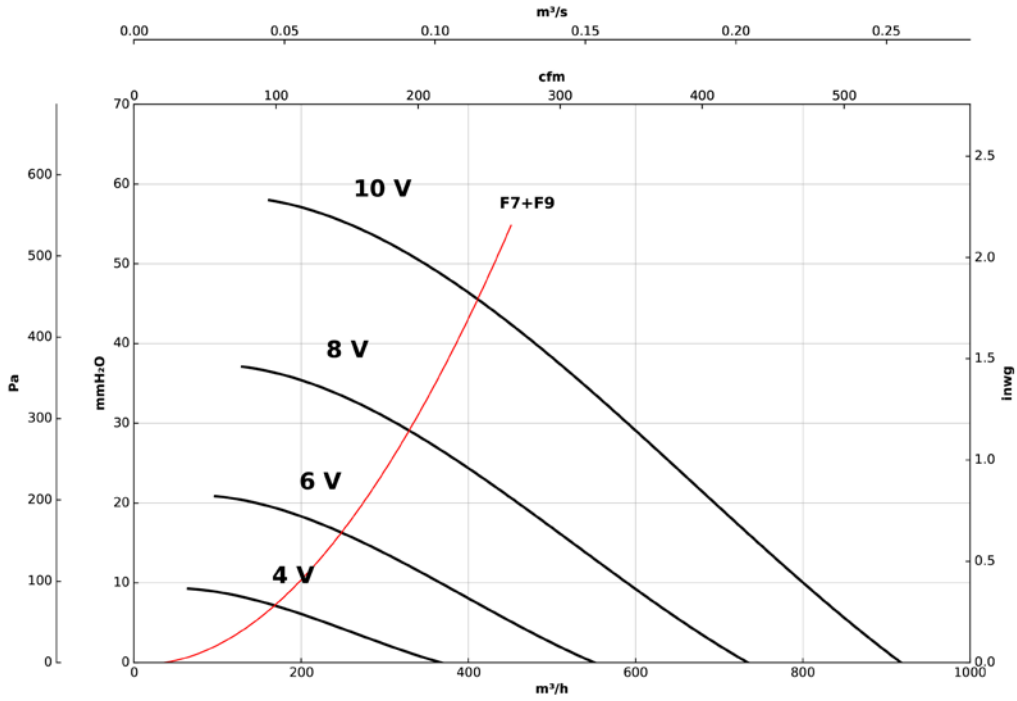

CJK/FILTER/EC -250

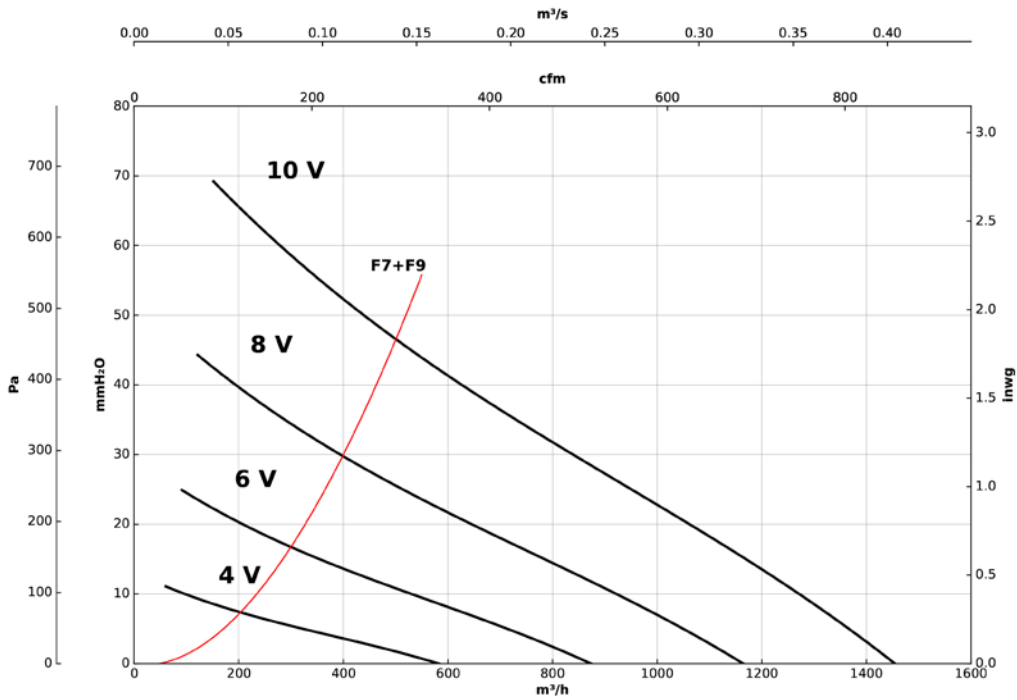

Characteristic curves

Q= Flow rate in m³/h, m³/s and cfm

Pe= Static pressure in mm H₂O, Pa and inwg

CJK/FILTER/EC -310

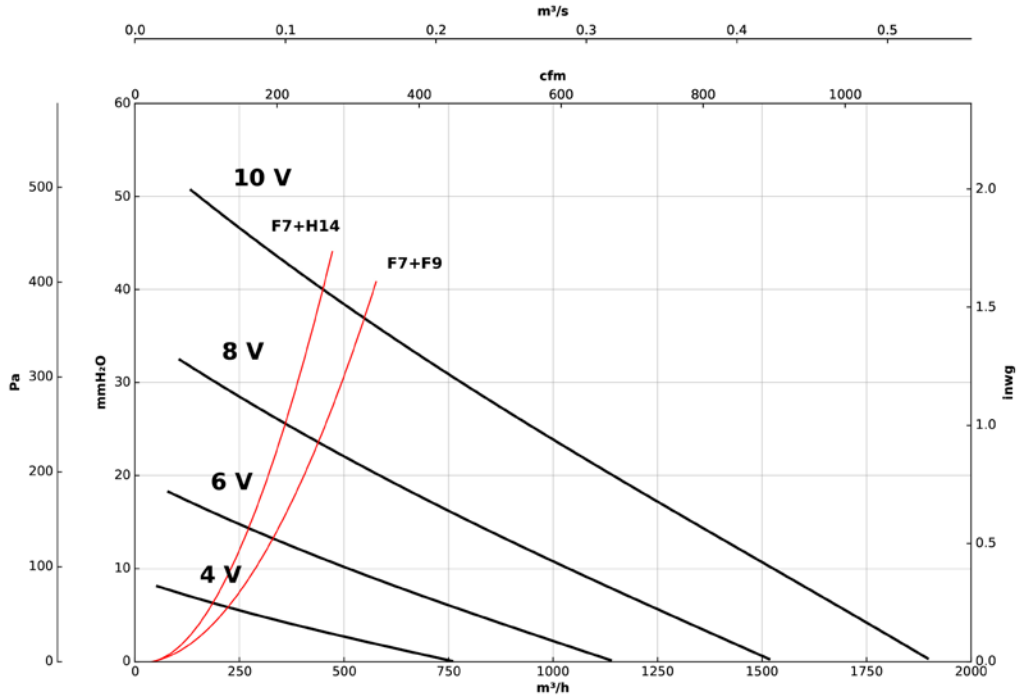

CJK/FILTER/EC -400

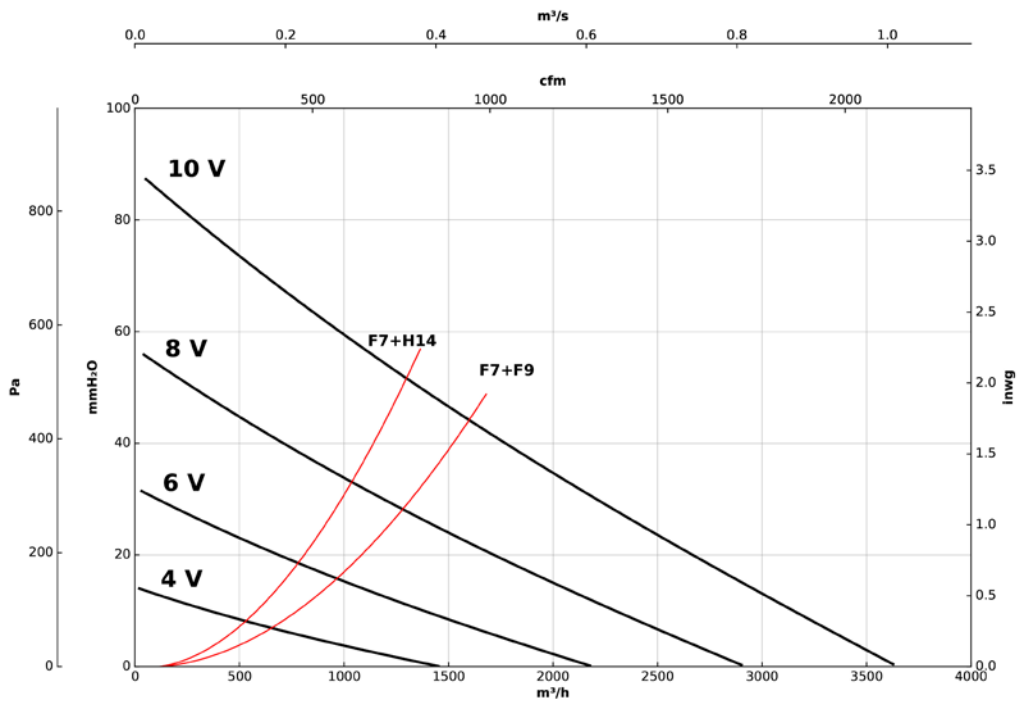

Characteristic curves

Q= Flow rate in m³/h, m³/s and cfm

Pe= Static pressure in mm H₂O, Pa and inwg

CJK/FILTER/EC -500

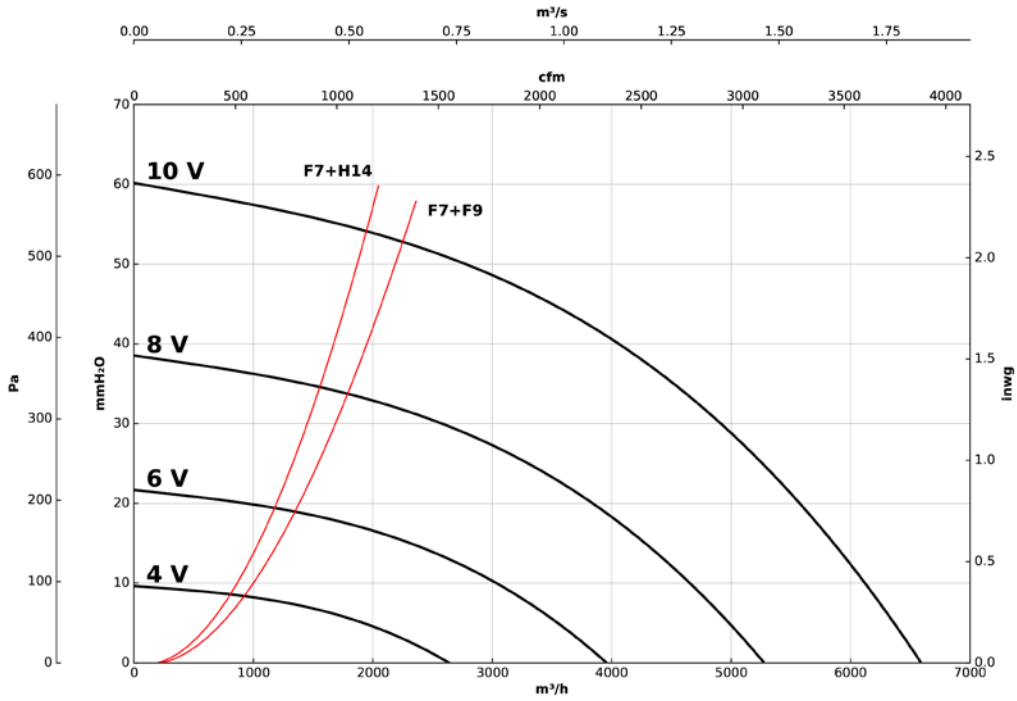

CJBD/ALF

Ventilation units with pre-lacquered sheet metal, built-in filter and aluminum profiles

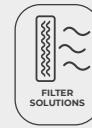

Fan:

- CBD series double inlet fans.
- Aluminium profile structure with thermal insulation and soundproofing.
- Forward curved impeller in galvanized sheet steel.
- Glands for cable entry.

Motor:

- Enclosed motors with built-in thermal protector, class F, with ball bearings, IP54 protection.
- Single-phase 220-240 V 50 Hz and

- three-phase 240 V/380-415 V 50 Hz.
- Maximum temperature of air to be carried: -20 °C +60 °C.

Finish:

- Anti-corrosive in pre-lacquered steel sheet and aluminum profiles.

On request:

- With circular outlet.

Order code

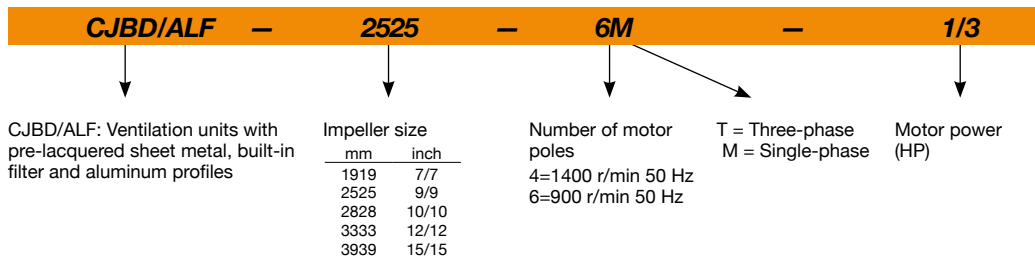

Technical characteristics

Model	Speed (r/min)	Maximum admissible current (A)		Installed power (kW)	Maximum flow rate (m³/h)	Noise level dB (A)	Approx. weight (Kg)	According ErP
		230V	400V					
CJBD/ALF-1919-4M 1/5	1320	1.15		0.15	1520	53	29	2018
CJBD/ALF-1919-6M 1/10	820	0.85		0.08	1230	48	29	2018
CJBD/ALF-2525-4M 1/2	1320	2.30		0.37	2800	61	41	2018
CJBD/ALF-2525-4M 3/4	1310	3.65		0.55	3600	65	41	2018
CJBD/ALF-2525-6M 1/3	830	2.20		0.25	2700	56	40	2018
CJBD/ALF-2525-6M 1/5	850	1.50		0.15	2200	54	39	2018
CJBD/ALF-2828-4M 1/2	1320	2.30		0.37	2800	60	48	2018
CJBD/ALF-2828-4M 3/4	1310	3.65		0.55	3950	65	49	2018
CJBD/ALF-2828-6M 1/3	830	1.60		0.25	3200	56	48	2018
CJBD/ALF-3333-6M 1	850	5.37		0.75	6000	65	68	2018
CJBD/ALF-3333-6M 3/4	850	3.30		0.55	4900	58	67	2018
CJBD/ALF-3333-6T 1 1/2	900	6.60	3.80	1.10	7800	69	68	2018
CJBD/ALF-3939-6T 3	890	10.90	6.30	2.20	11900	72	98	2018



Erp. (Energy Related Products)

Information on Directive 2009/125/EC can be downloaded from the SODECA website or the QuickFan selector programme.

Acoustic characteristics

Sound power spectrum Lw(A) in dB(A) per Hz frequency band

	63	125	250	500	1000	2000	4000	8000		63	125	250	500	1000	2000	4000	8000
CJBD/ALF-1919-4M 1/5	43	54	58	62	64	63	62	53	CJBD/ALF-2828-4M 3/4	55	66	70	74	76	75	74	65
CJBD/ALF-1919-6M 1/10	38	49	53	57	59	58	57	48	CJBD/ALF-2828-6M 1/3	46	57	61	65	67	66	65	56
CJBD/ALF-2525-4M 1/2	51	62	66	70	72	71	70	61	CJBD/ALF-3333-6T 1 1/2	59	70	74	78	80	79	78	69
CJBD/ALF-2525-4M 3/4	55	66	70	74	76	75	74	65	CJBD/ALF-3333-6M 3/4	48	59	63	67	69	68	67	58
CJBD/ALF-2525-6M 1/6	44	55	59	63	65	64	63	54	CJBD/ALF-3333-6M 1	55	66	70	74	76	75	74	65
CJBD/ALF-2525-6M 1/3	46	57	61	65	67	66	65	56	CJBD/ALF-3939-6T 3	61	72	77	81	83	81	80	71
CJBD/ALF-2828-4M 1/2	50	61	65	69	71	70	69	60									

Dimensions mm

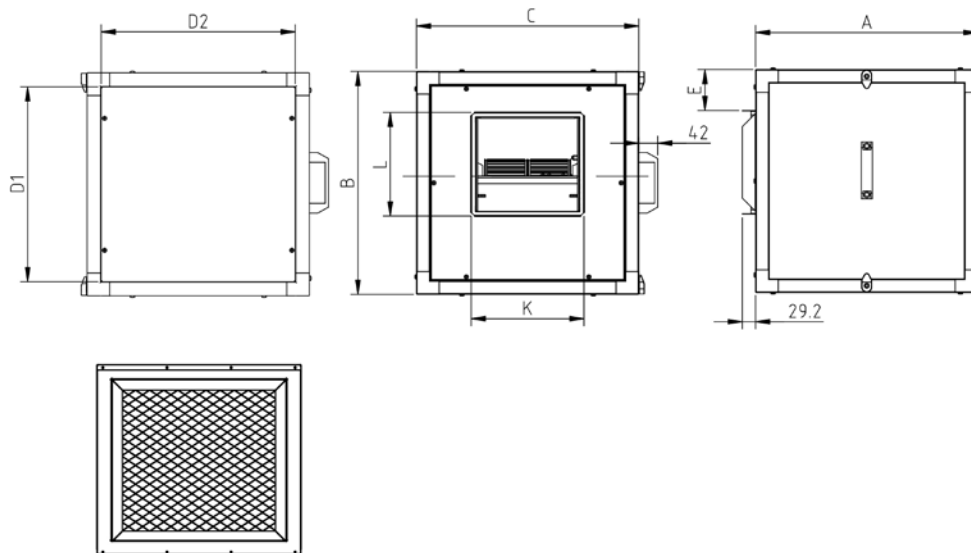

	A	B	C	D1	D2	E	L	K
CJBD/ALF-1919	490	490	490	428	428	91	226	247
CJBD/ALF-2525	550	550	550	488	488	86	279	317
CJBD/ALF-2828	605	605	605	543	543	88	306	343
CJBD/ALF-3333	680	680	680	618	618	84	360	404
CJBD/ALF-3939	855	855	855	793	793	119	423	490

Characteristic curves

Q= Flow rate in m³/h, m³/s and cfm

Pe= Static pressure in mm H₂O, Pa and inwg

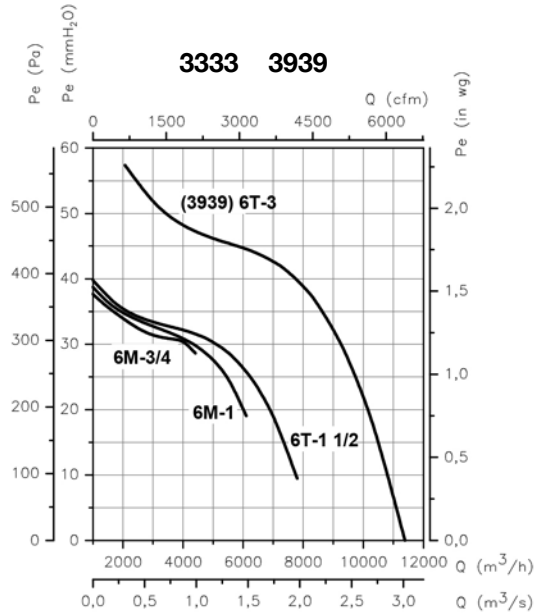
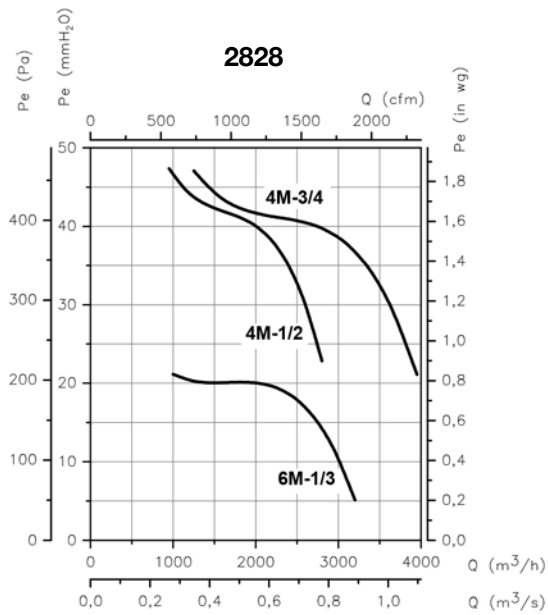
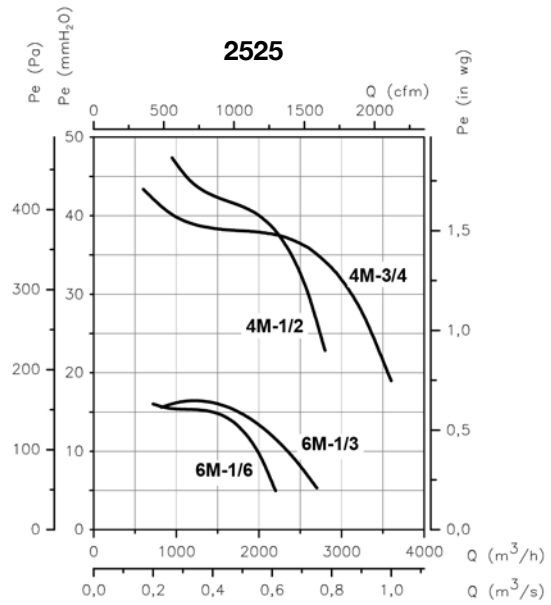
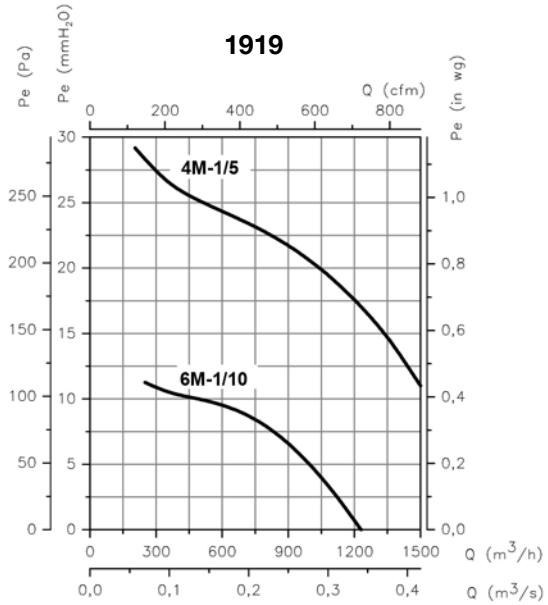

FILTRATION AND DISINFECTION UNITS

Characteristic curves

Q= Flow rate in m³/h, m³/s and cfm

Pe= Static pressure in mm H₂O, Pa and inwg

Load loss curves of units with filters

CJBD/ALF

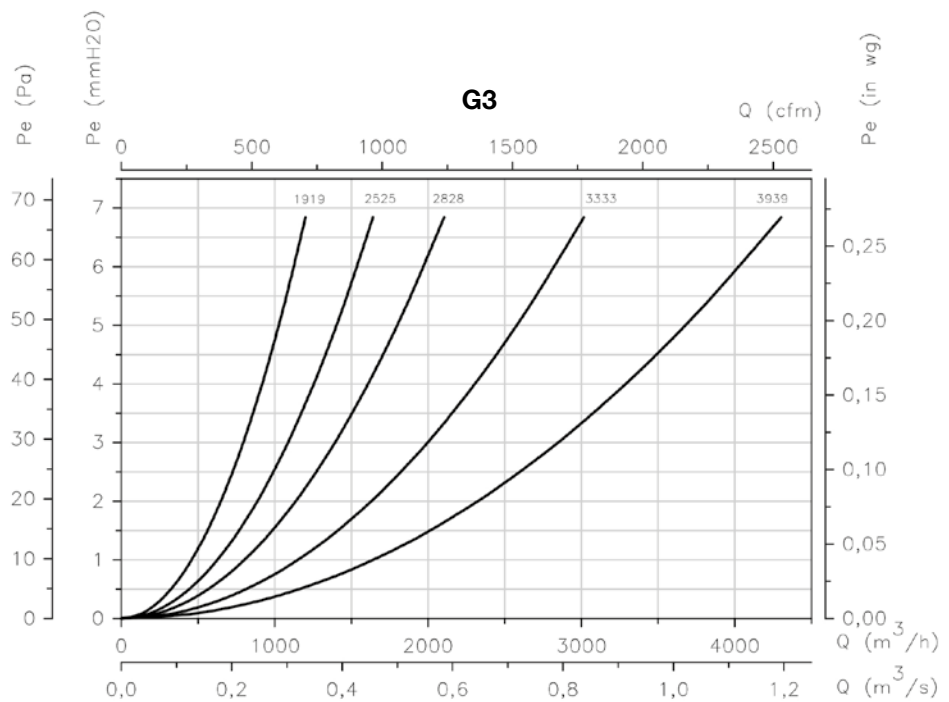
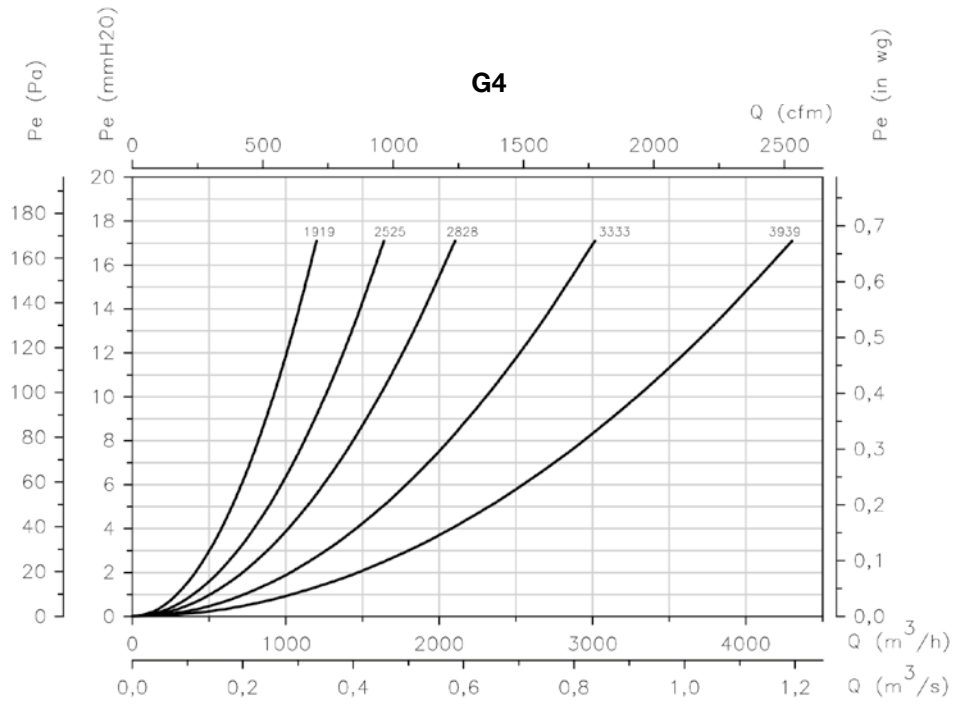

Accessories



INT



C2V



RM



VSD3/A-RFT
- VSD1/A-RFM



AET



TEJ



VIS



MF



MCA



MFE



MPCO

CJBX/ALF

Belt driven ventilation units with pre-lacquered sheet, built-in filters and aluminium profiles

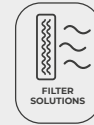

Fan:

- Ventilation units equipped with double inlet fans of the CBX, CBXC and CBXR series.
- Aluminium profile structure with thermal insulation and soundproofing.
- Forward curved impeller in galvanized sheet steel.
- Glands for cable entry.

- Three-phase 230/400 V 50 Hz (up to 4 kW) and 400/690 V 50 Hz (powers greater than 4 kW).
- Maximum temperature of air to be carried: -20 °C +60 °C.

Finish:

- Anti-corrosive in pre-lacquered steel sheet and aluminum profiles.

Motor:

- Motors with IE3 efficiency for powers equal to or greater than 0.75 kW, except single-phase, 2-speed and 8-pole.
- Class F motors with ball bearings and IP55 protection.

On request:

- With circular outlet.

Order code

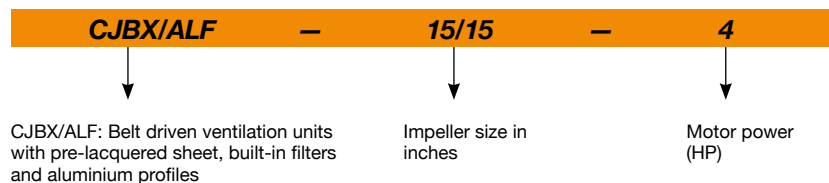

Technical characteristics

Model	Speed (r/min)	Maximum admissible current (A)			Installed power (kW)	Maximum flow rate (m ³ /h)	Sound pressure level dB (A)	Approx. weight (Kg)	Mounting type	According ErP
		230V	400V	690V						
CJBX/ALF-7/7-0.75	1400	2.92	1.69		0.55	1200	56	41	A	2018
CJBX/ALF-7/7-1 IE3	1600	3.10	1.79		0.75	1450	58	43	A	2018
CJBX/ALF-9/9-0.25	825	1.23	0.71		0.18	1700	45	48	A	2018
CJBX/ALF-9/9-0.33	920	1.66	0.96		0.25	1800	48	50	A	2018
CJBX/ALF-9/9-0.5	1020	2.02	1.17		0.37	2200	51	52	A	2018
CJBX/ALF-9/9-0.75	1050	2.92	1.69		0.55	2900	55	55	A	2018
CJBX/ALF-9/9-1 IE3	1070	3.10	1.79		0.75	3200	56	56	A	2018
CJBX/ALF-9/9-1.5 IE3	1260	4.03	2.32		1.10	3750	60	59	A	2018
CJBX/ALF-10/10-0.75	845	2.92	1.69		0.55	3800	56	57	A	2018
CJBX/ALF-10/10-1 IE3	960	3.10	1.79		0.75	4175	58	59	A	2018
CJBX/ALF-10/10-1.5 IE3	1070	4.03	2.32		1.10	4800	61	61	A	2018
CJBX/ALF-10/10-2 IE3	1140	5.96	3.44		1.50	5400	63	65	A	2018
CJBX/ALF-12/12-0.5	595	2.02	1.17		0.37	4200	52	69	A	2018
CJBX/ALF-12/12-0.75	675	2.92	1.69		0.55	4800	54	71	A	2018
CJBX/ALF-12/12-1 IE3	765	3.10	1.79		0.75	5400	57	72	A	2018
CJBX/ALF-12/12-1.5 IE3	855	4.03	2.32		1.10	5800	59	75	A	2018
CJBX/ALF-12/12-2 IE3	965	5.96	3.44		1.50	6500	62	79	A	2018

Technical characteristics

Model	Speed (r/min)	Maximum admissible current (A)			Installed power (kW)	Maximum flow rate (m ³ /h)	Sound pressure level dB (A)	Approx. weight (Kg)	Mounting type	According ErP
		230V	400V	690V						
CJBX/ALF-12/12-3 IE3	1180	8.36	4.83		2.20	7400	65	87	A	2018
CJBX/ALF-15/15-0.75	525	2.92	1.69		0.55	5900	49	85	B	2018
CJBX/ALF-15/15-1 IE3	595	3.10	1.79		0.75	6500	52	86	B	2018
CJBX/ALF-15/15-1.5 IE3	635	4.03	2.32		1.10	7500	54	89	B	2018
CJBX/ALF-15/15-2 IE3	670	5.96	3.44		1.50	8200	56	93	B	2018
CJBX/ALF-15/15-3 IE3	740	8.36	4.83		2.20	9500	59	101	B	2018
CJBX/ALF-15/15-4 IE3	805	10.96	6.33		3.00	10600	61	103	B	2018
CJBX/ALF-18/18-1.5 IE3	480	4.03	2.32		1.10	9000	48	122	B	2018
CJBX/ALF-18/18-2 IE3	605	5.96	3.44		1.50	9250	51	125	B	2018
CJBX/ALF-18/18-3 IE3	590	8.36	4.83		2.20	11500	54	134	B	2018
CJBX/ALF-18/18-4 IE3	640	10.96	6.33		3.00	13200	56	136	B	2018
CJBX/ALF-18/18-5.5 IE3	675	14.10	8.12		4.00	15000	58	141	B	2018
CJBX/ALF-18/18-7.5 IE3	760		11.60	6.72	5.50	17000	60	155	B	2018
CJBX/ALF-20/20-2 IE3	430	5.96	3.44		1.50	11500	56	222	B	2018
CJBX/ALF-20/20-3 IE3	530	8.36	4.83		2.20	12800	57	231	B	2018
CJBX/ALF-20/20-4 IE3	575	10.96	6.33		3.00	14200	58	233	B	2018
CJBX/ALF-20/20-5.5 IE3	635	14.10	8.12		4.00	15500	61	238	B	2018
CJBX/ALF-20/20-7.5 IE3	675		11.60	6.72	5.50	17500	63	252	B	2018
CJBX/ALF-20/20-10 IE3	725		13.90	8.06	7.50	20000	65	283	B	2018
CJBX/ALF-22/22-2 IE3	385	5.96	3.44		1.50	14000	50	250	B	2018
CJBX/ALF-22/22-3 IE3	475	8.36	4.83		2.20	15000	54	257	B	2018
CJBX/ALF-22/22-4 IE3	515	10.96	6.33		3.00	17000	55	261	B	2018
CJBX/ALF-22/22-5.5 IE3	570	14.10	8.12		4.00	19000	57	265	B	2018
CJBX/ALF-22/22-7.5 IE3	605		11.60	6.72	5.50	21500	60	279	B	2018
CJBX/ALF-22/22-10 IE3	675		13.90	8.06	7.50	25000	63	306	B	2018
CJBX/ALF-22/22-15 IE3	765		20.90	12.10	11.00	27000	65	341	B	2018
CJBX/ALF-25/25-3 IE3	375	8.36	4.83		2.20	17000	53	297	B	2018
CJBX/ALF-25/25-4 IE3	405	10.96	6.33		3.00	20500	55	299	B	2018
CJBX/ALF-25/25-5.5 IE3	450	14.10	8.12		4.00	22000	57	304	B	2018
CJBX/ALF-25/25-7.5 IE3	485		11.60	6.72	5.50	24500	59	318	B	2018
CJBX/ALF-25/25-10 IE3	545		13.90	8.06	7.50	28000	61	345	B	2018
CJBX/ALF-25/25-15 IE3	610		20.90	12.10	11.00	32000	64	374	B	2018
CJBX/ALF-30/28-3 IE3	330	8.36	4.83		2.20	20000	54	380	B	2018
CJBX/ALF-30/28-4 IE3	360	10.96	6.33		3.00	22000	56	382	B	2018
CJBX/ALF-30/28-5.5 IE3	380	14.10	8.12		4.00	25000	59	387	B	2018
CJBX/ALF-30/28-7.5 IE3	380		11.60	6.72	5.50	31500	60	402	B	2018
CJBX/ALF-30/28-10 IE3	410		13.90	8.06	7.50	36000	63	431	B	2018
CJBX/ALF-30/28-15 IE3	430		20.90	12.10	11.00	42000	65	451	B	2018
CJBX/ALF-30/28-20 IE3	480		27.90	16.20	15.00	48000	68	466	B	2018



Erp. (Energy Related Products)

Information on Directive 2009/125/EC can be downloaded from the SODECA website or the QuickFan selector programme.

Dimensions mm

CJBX/ALF
Standard supply
horizontal impulsion
(H) LG 90

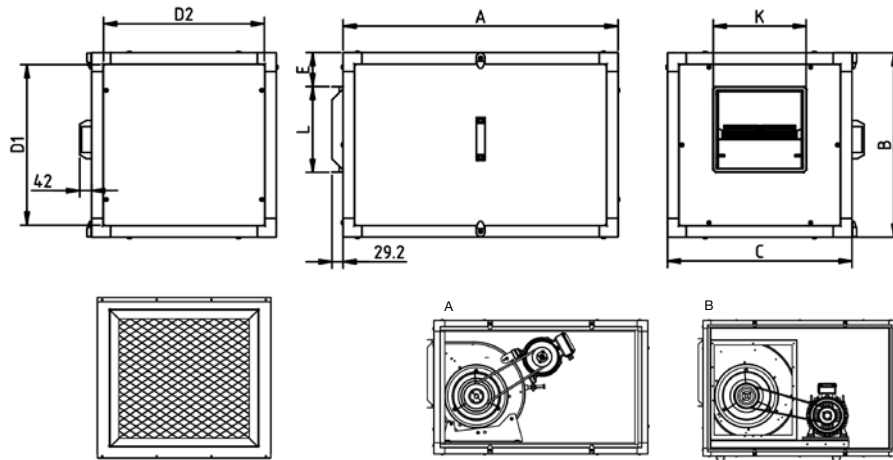

	A	B	C	D1	D2	E	L	K	Mounting type
CJBX/ALF-7/7	830	490	490	428	428	91	226	247	A
CJBX/ALF-9/9	920	550	550	488	488	86	279	317	A
CJBX/ALF-10/10	970	605	605	543	543	88	306	343	A
CJBX/ALF-12/12	1050	680	680	618	618	84	360	404	A
CJBX/ALF-15/15	1220	855	855	793	793	119	423	490	B
CJBX/ALF-18/18	1356	1000	1000	938	938	137	498	554	B
CJBX/ALF-20/20	1500	1195	1195	1115	1115	140	615	615	B
CJBX/ALF-22/22	1600	1250	1250	1170	1170	104	705	668	B
CJBX/ALF-25/25	1870	1450	1450	1370	1370	200	792	767	B
CJBX/ALF-30/28	1975	1670	1670	1590	1590	188	938	896	B

CJBX/ALF
On request vertical
impulsion (V) LG 0

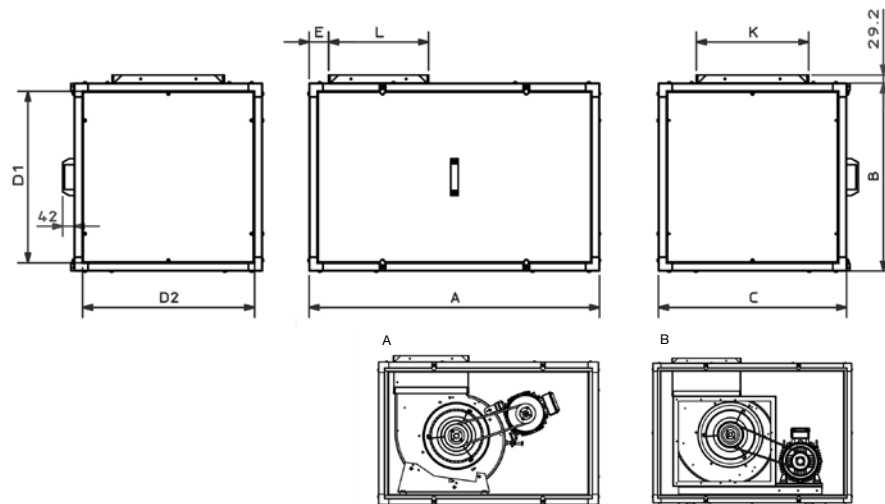

	A	B	C	D1	D2	E	L	K	Mounting type
CJBX/ALF-7/7	830	490	490	428	428	63	226	247	A
CJBX/ALF-9/9	920	550	550	488	488	85	279	317	A
CJBX/ALF-10/10	970	605	605	543	543	87	306	343	A
CJBX/ALF-12/12	1050	680	680	618	618	69	360	404	A
CJBX/ALF-15/15	1220	855	855	793	793	115	423	490	B
CJBX/ALF-18/18	1356	1000	1000	938	938	80	498	554	B
CJBX/ALF-20/20	1500	1195	1195	1115	1115	125	615	615	B
CJBX/ALF-22/22	1600	1250	1250	1170	1170	125	705	668	B
CJBX/ALF-25/25	1870	1450	1450	1370	1370	85	792	767	B
CJBX/ALF-30/28	1975	1670	1670	1590	1590	155	938	896	B

Characteristic curves

Q= Flow rate in m³/h, m³/s and cfm

Pe= Static pressure in mm H₂O, Pa and inwg

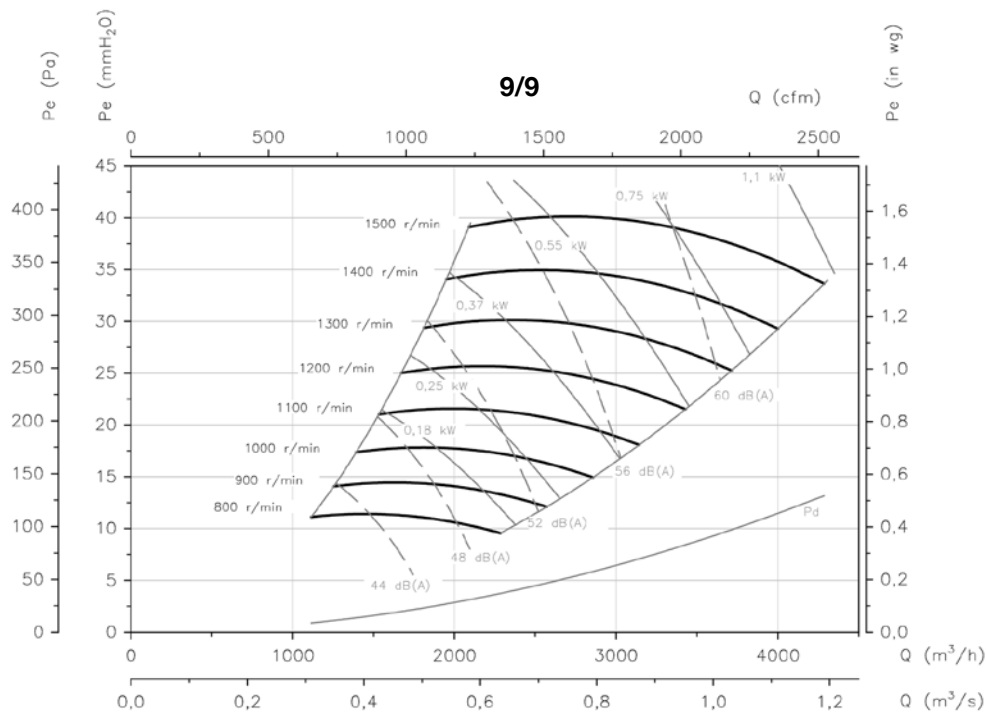
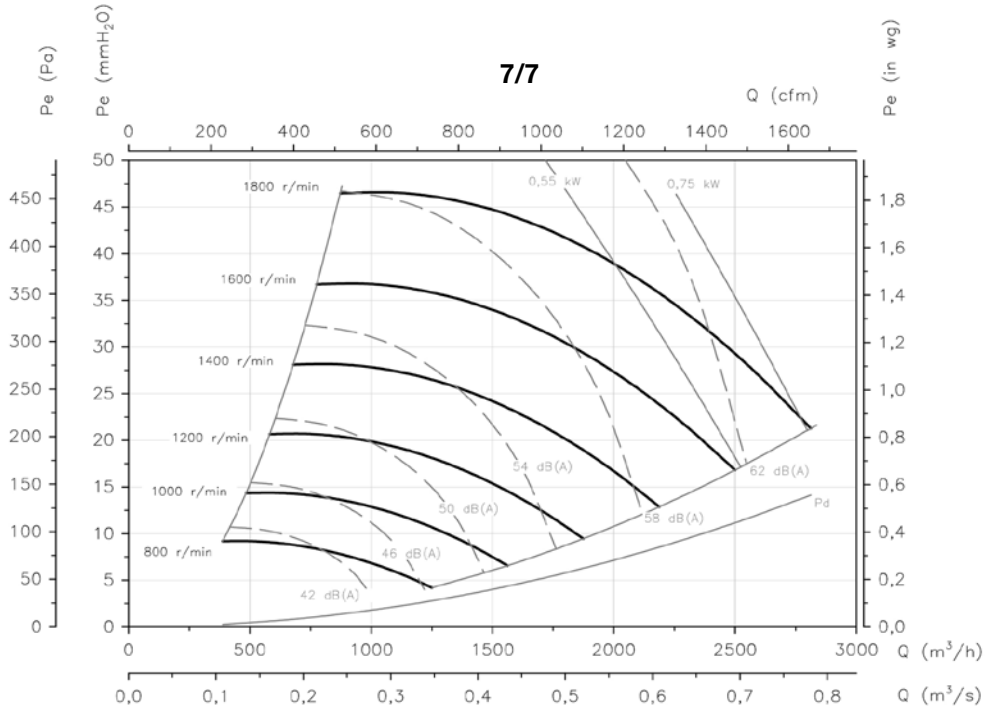

Characteristic curves

Q= Flow rate in m³/h, m³/s and cfm

Pe= Static pressure in mm H₂O, Pa and inwg

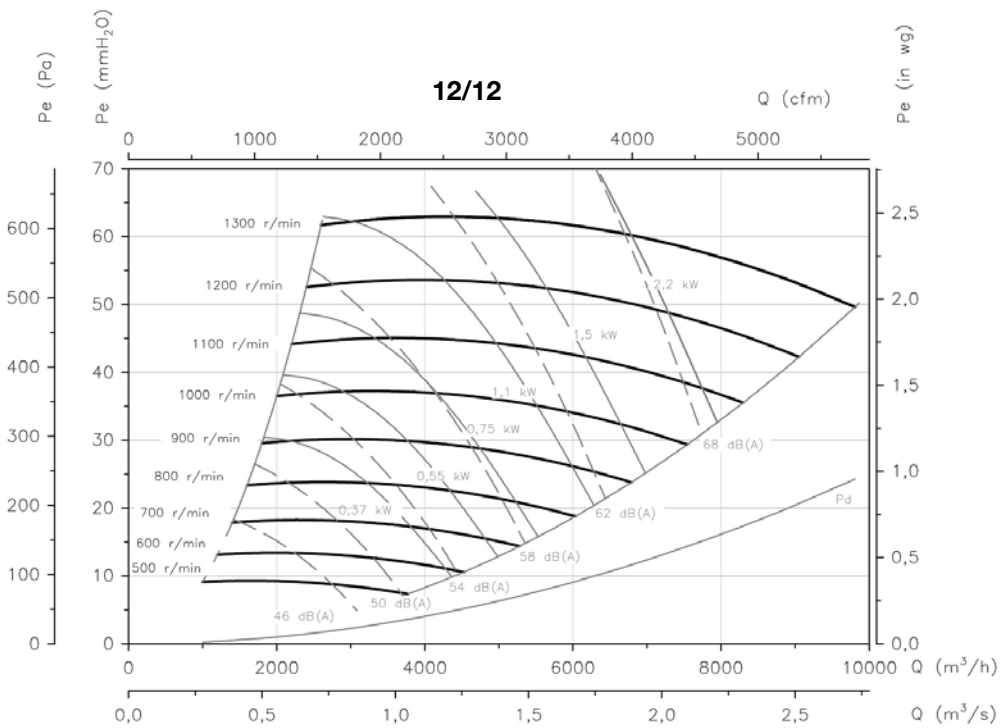
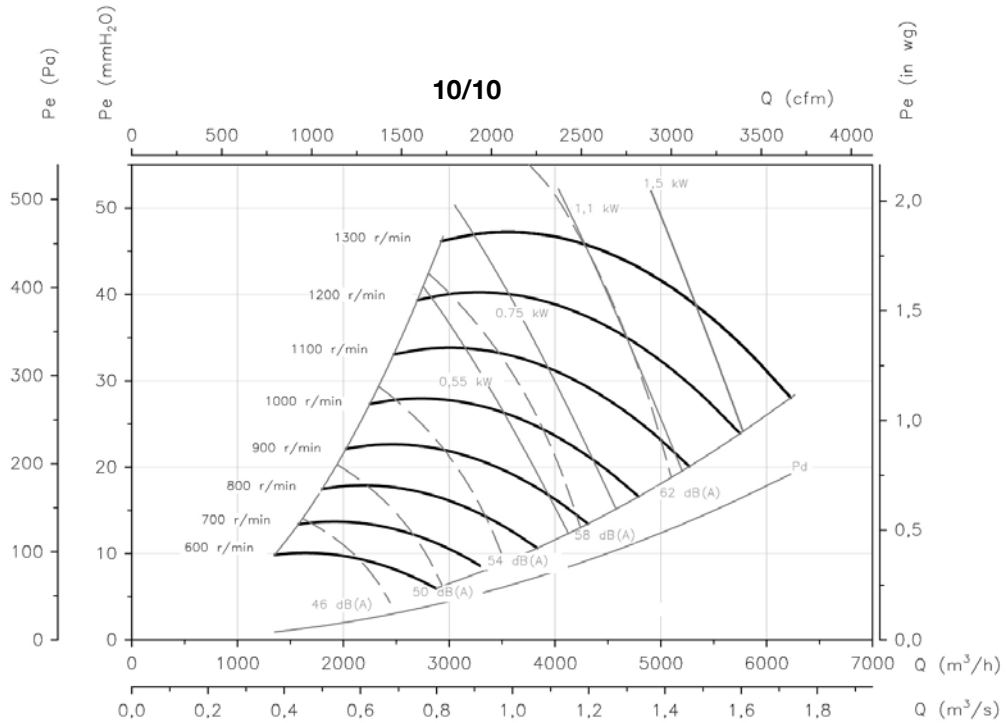

Characteristic curves

Q= Flow rate in m³/h, m³/s and cfm

Pe= Static pressure in mm H₂O, Pa and inwg

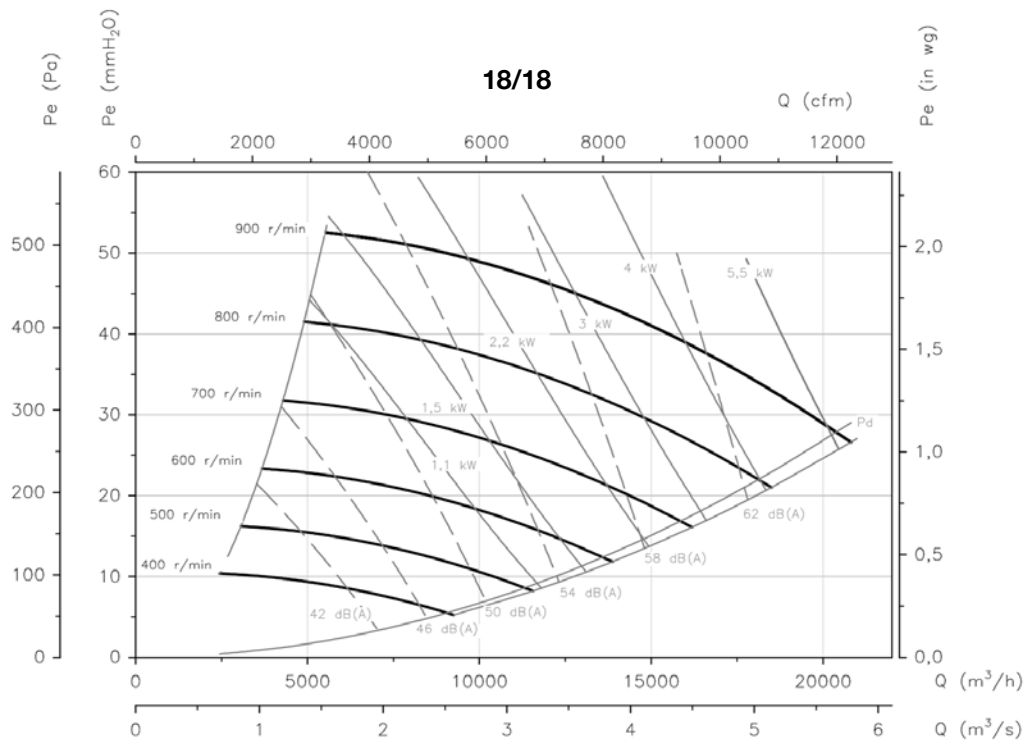
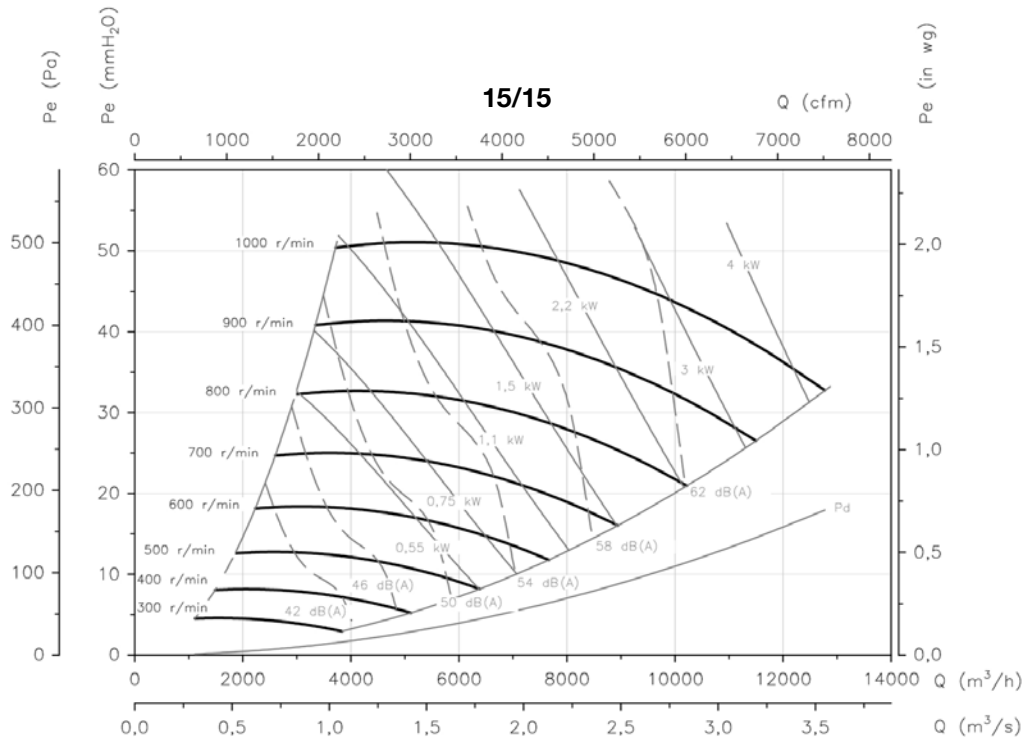

Characteristic curves

Q= Flow rate in m³/h, m³/s and cfm

Pe= Static pressure in mm H₂O, Pa and inwg

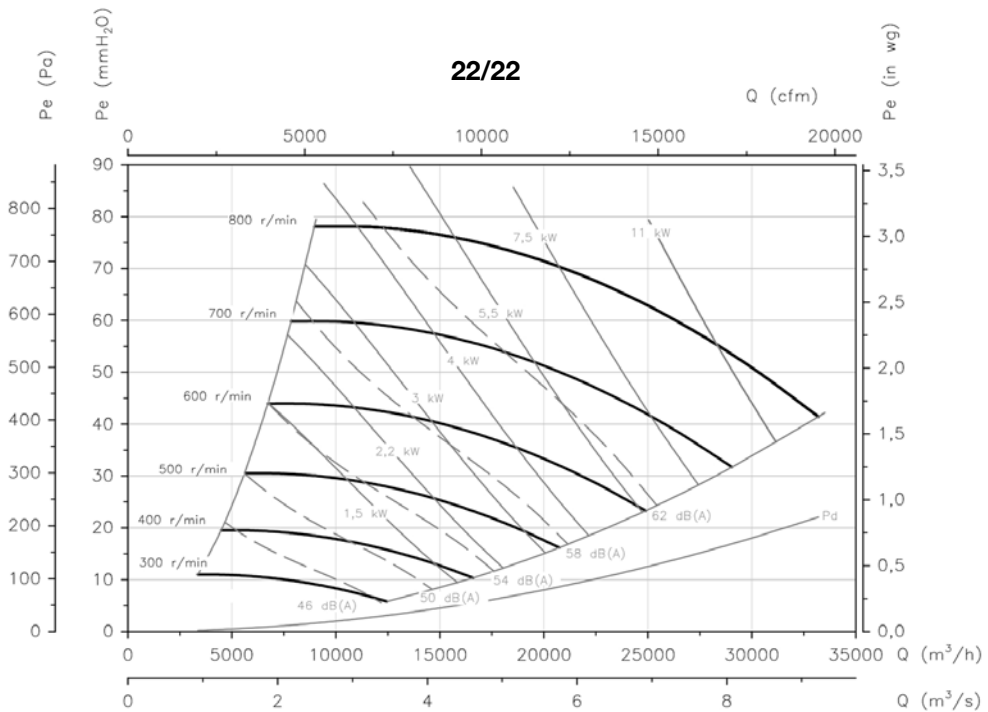
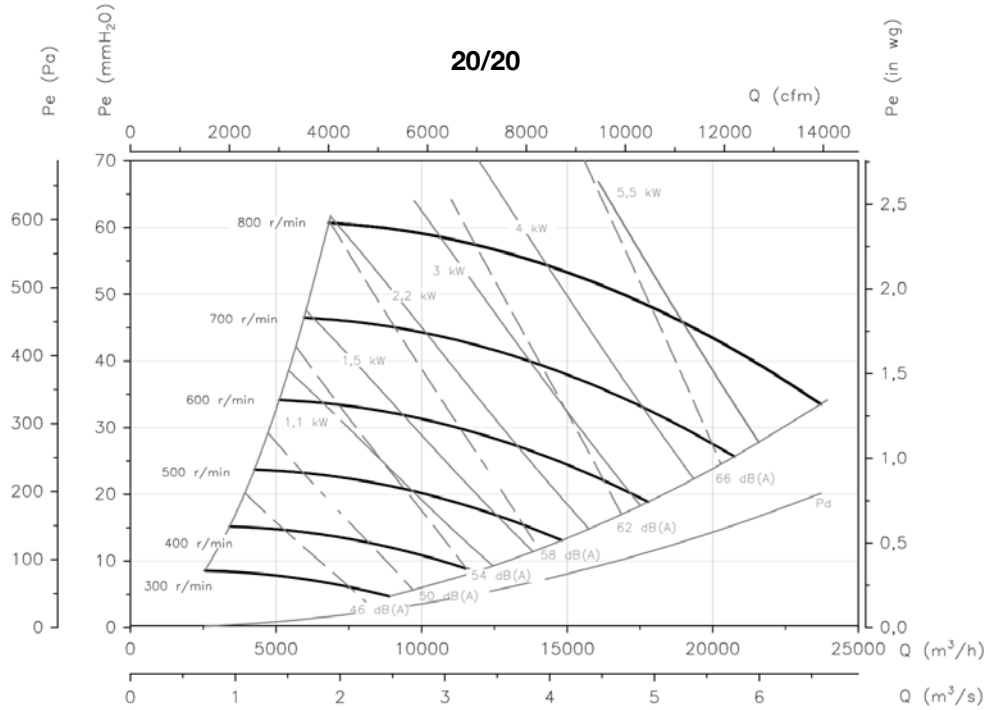

Characteristic curves

Q= Flow rate in m³/h, m³/s and cfm

Pe= Static pressure in mm H₂O, Pa and inwg

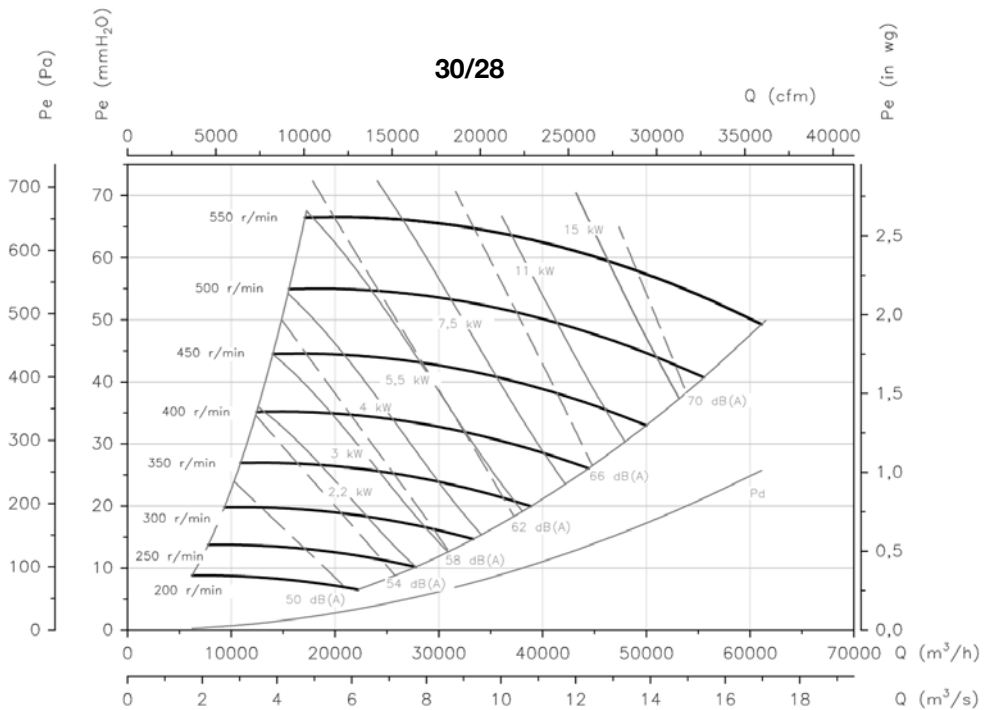
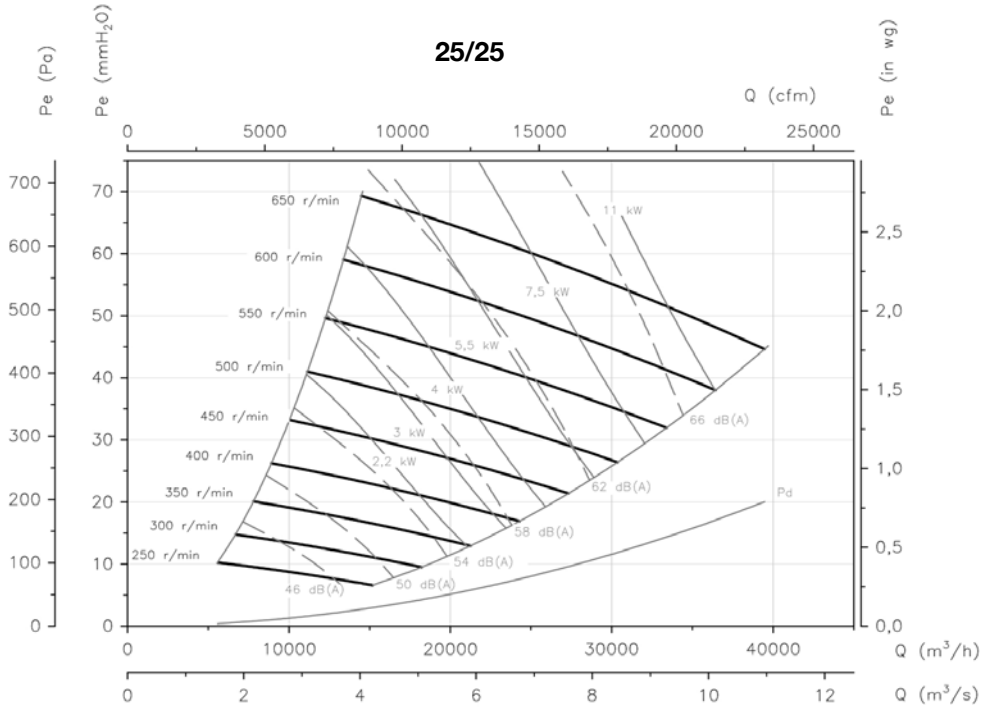

Characteristic curves

Q= Flow rate in m³/h, m³/s and cfm

Pe= Static pressure in mm H₂O, Pa and inwg

Load loss curves of units with filters

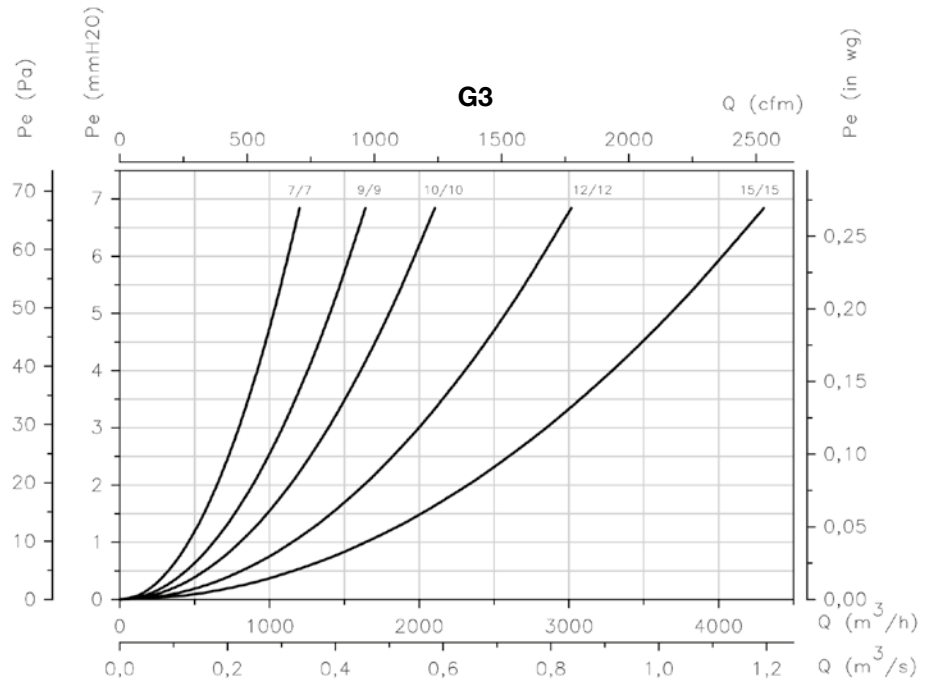
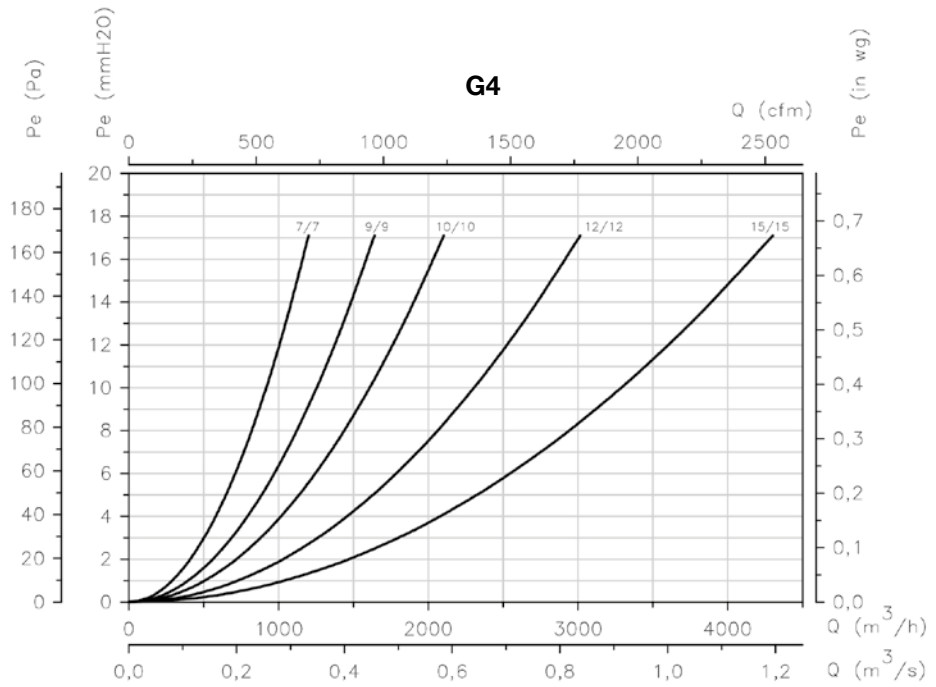

FILTRATION AND DISINFECTION UNITS

Characteristic curves

Q= Flow rate in m³/h, m³/s and cfm

Pe= Static pressure in mm H₂O, Pa and inwg

Load loss curves of units with filters

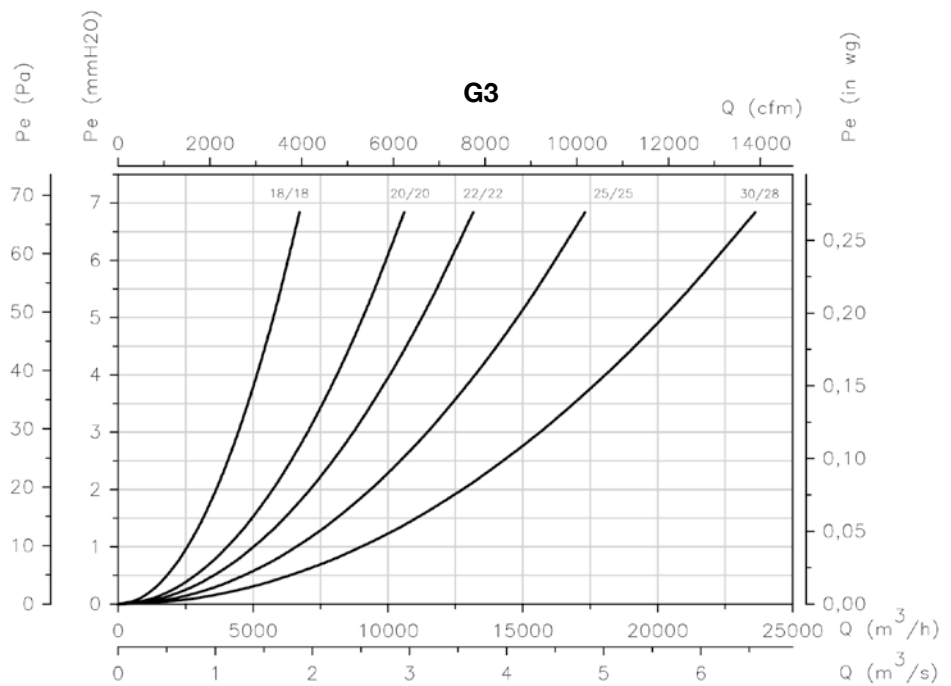
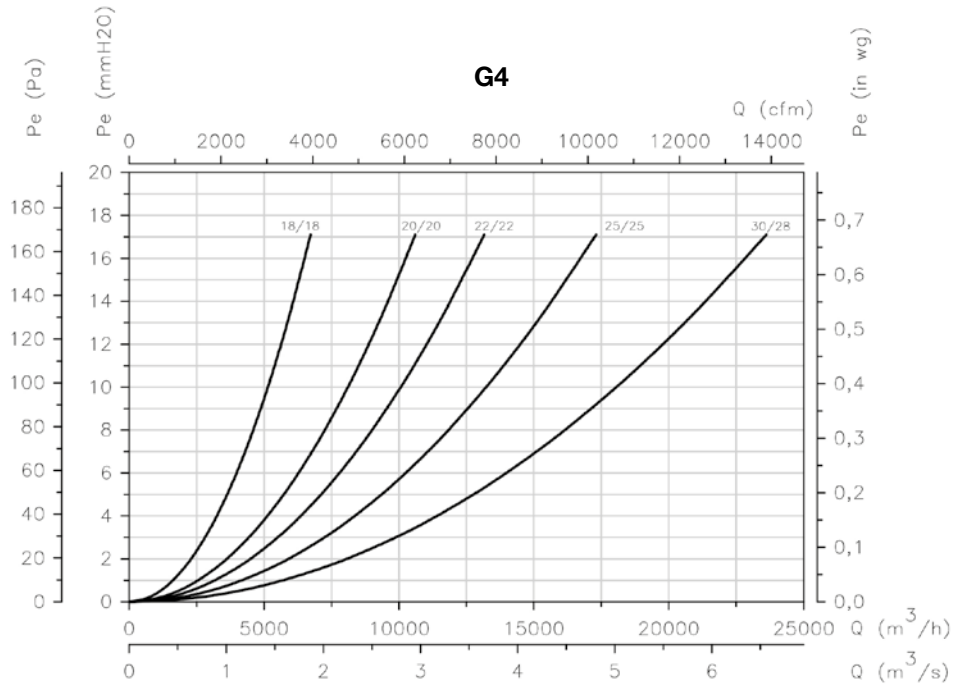

Accessories



INT



C2V



RM



VSD3/A-RFT
- VSD1/A-RFM



AET



TEJ



VIS



MF



MCA



MFE



MPCO

UFRX/ALS PCO

Air purifying units with photocatalysis-based technology

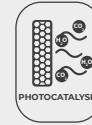

Filtration, disinfection and air purification units with photocatalysis technology, especially designed for disinfecting and cleaning indoor air and nearby surfaces.

Characteristics:

- Aluminium profile structure.
- Covers with a high quality, 25 mm thick acoustic casing made of prefinished sheet.
- Backward curved impeller.
- Built-in photocatalyst device with negative and positive ionisation.
- Filtration stages: F7 + F9.
- Inspection cover for filter maintenance and replacement.
- Effective for up to 40 linear metres of ducting.
- Belt-driven.
- Glands for cable entry.

Motor:

- IE3 efficiency motors.
- Class F motors with ball bearings and IP55 protection.
- Three-phase 230/400 V 50 Hz (up to 4 kW) and 400/690 V 50 Hz (powers greater than 4 kW).
- Maximum temperature of air to be carried: -20 °C +60 °C.

Finish:

- Aluminium profile and prefinished sheet, with 25 mm thick double-wall thermal and acoustic insulation panels.

On request:

- Circular outlet.

Order code

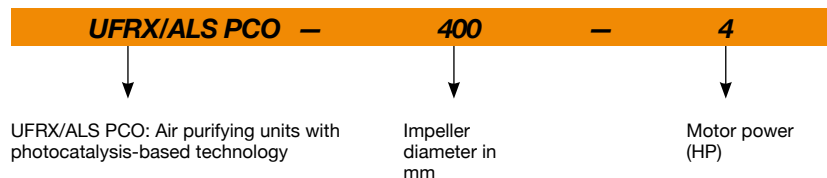

Filter characteristics

STANDARD FILTERS	EN 779	EN 1822	ISO 16890			
	<i>Em</i>		ISO ePM ₁	ISO ePM _{2,5}	ISO ePM ₁₀	ISO COARSE
F7	90%	-	>50%	>65-95%	>85%	-
F9	95%	-	>80%	>95%	>95%	-

Technical characteristics

Model	Speed (r/min)	Maximum admissible current (A)			Installed power (kW)	Maximum flow rate (m ³ /h)	Sound pressure level dB (A)	Air temperature (°C)		Approx. weight (Kg)	According ErP
		230V	400V	690V				min.	max.		
UFRX/ALS PCO-315-2 IE3	2100	5.34	3.07		1.50	6460	75	-20	+60	87	2018
UFRX/ALS PCO-315-3 IE3	2350	7.70	4.43		2.20	6460	75	-20	+60	92	2018
UFRX/ALS PCO-355-3 IE3	1930	7.93	4.56		2.20	8980	78	-20	+60	118	2018
UFRX/ALS PCO-355-4 IE3	2180	10.70	6.15		3.00	8980	78	-20	+60	124	2018
UFRX/ALS PCO-400-4 IE3	1820	10.70	6.15		3.00	10370	75	-20	+60	135	2018
UFRX/ALS PCO-400-5.5 IE3	2000	13.90	8.00		4.00	10370	75	-20	+60	147	2018
UFRX/ALS PCO-500-5.5 IE3	1370	13.90	8.00		4.00	15030	73	-20	+60	188	2018
UFRX/ALS PCO-500-7.5 IE3	1510		10.30	5.97	5.50	15030	73	-20	+60	214	2018
UFRX/ALS PCO-630-7.5 IE3	1020		11.20	6.49	5.50	23330	72	-20	+60	320	2018
UFRX/ALS PCO-630-10 IE3	1135		14.80	8.58	7.50	23330	72	-20	+60	340	2018



Erp. (Energy Related Products)

Information on Directive 2009/125/EC can be downloaded from the SODECA website or the QuickFan selector programme.

Dimensions mm

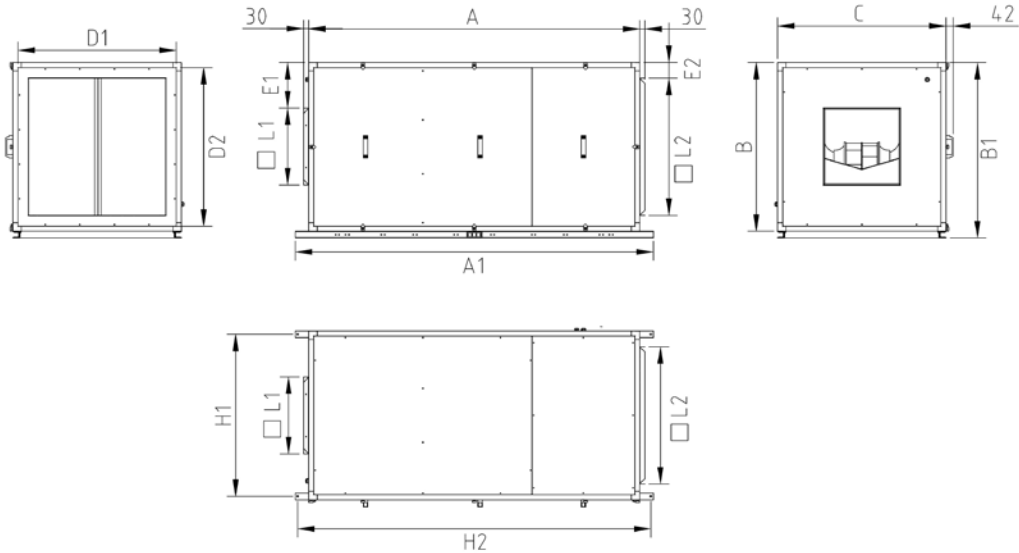

	A	A1	B	B1	C	D1	D2	E1	E2	L1	L2	H1	H2
UFRX/ALS PCO 315	1867	1998	855	895	855	795	795	200	85	405	685	815	1968
UFRX/ALS PCO 355	2005	2125	1000	1040	1000	940	940	270	90	455	815	960	2095
UFRX/ALS PCO 400	2130	2250	1195	1235	1195	1115	1115	365	130	510	930	1155	2220
UFRX/ALS PCO 500	2500	2620	1450	1490	1450	1370	1370	340	170	640	1110	1410	2590
UFRX/ALS PCO 630	2605	2725	1670	1710	1670	1590	1590	420	140	805	1395	1630	2695

Characteristic curves

Q= Flow rate in m³/h, m³/s and cfm

Pe= Static pressure in mm H₂O, Pa and inwg

UFRX/ALS PCO -315

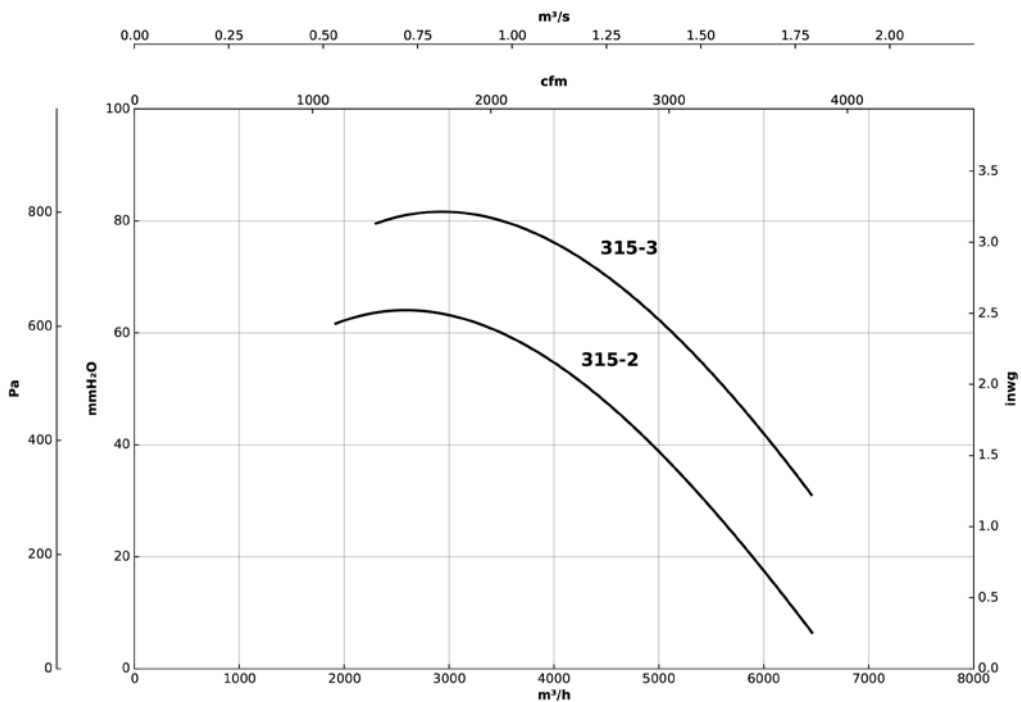

Characteristic curves

Q= Flow rate in m³/h, m³/s and cfm

Pe= Static pressure in mm H₂O, Pa and inwg

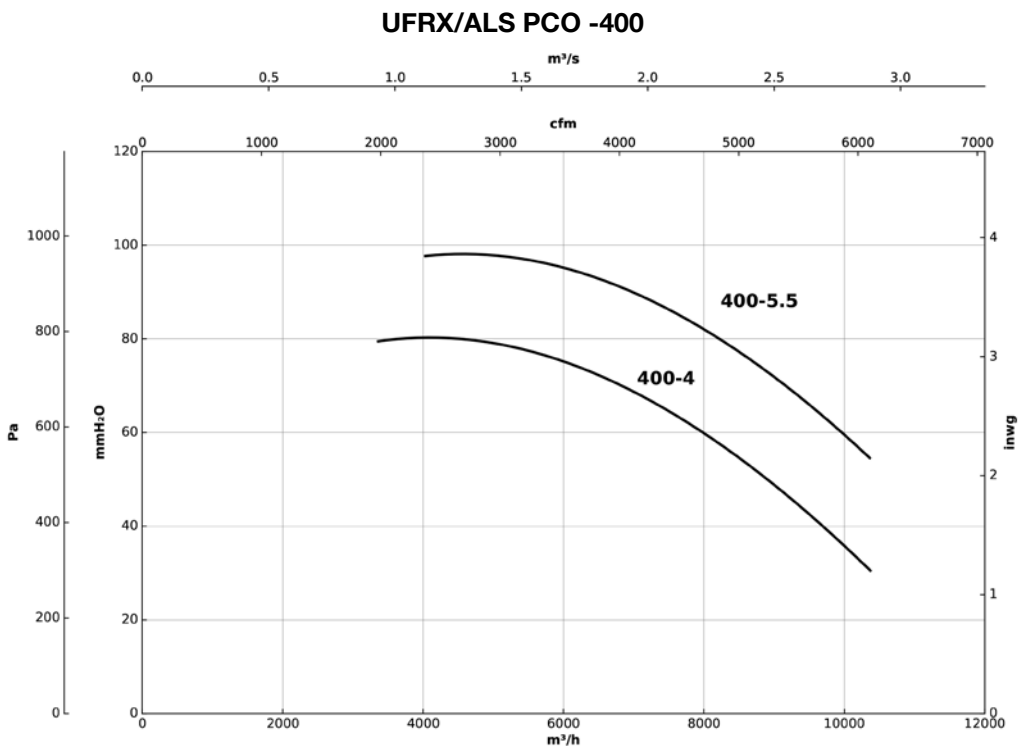
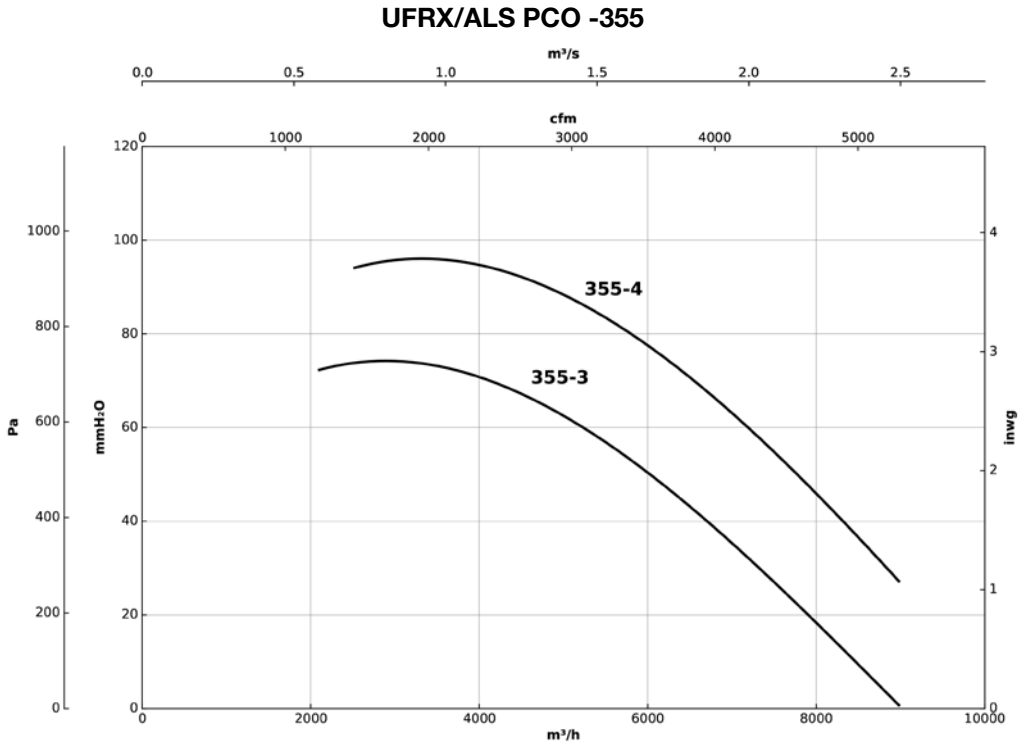

Characteristic curves

Q= Flow rate in m³/h, m³/s and cfm

Pe= Static pressure in mm H₂O, Pa and inwg

UFRX/ALS PCO -500

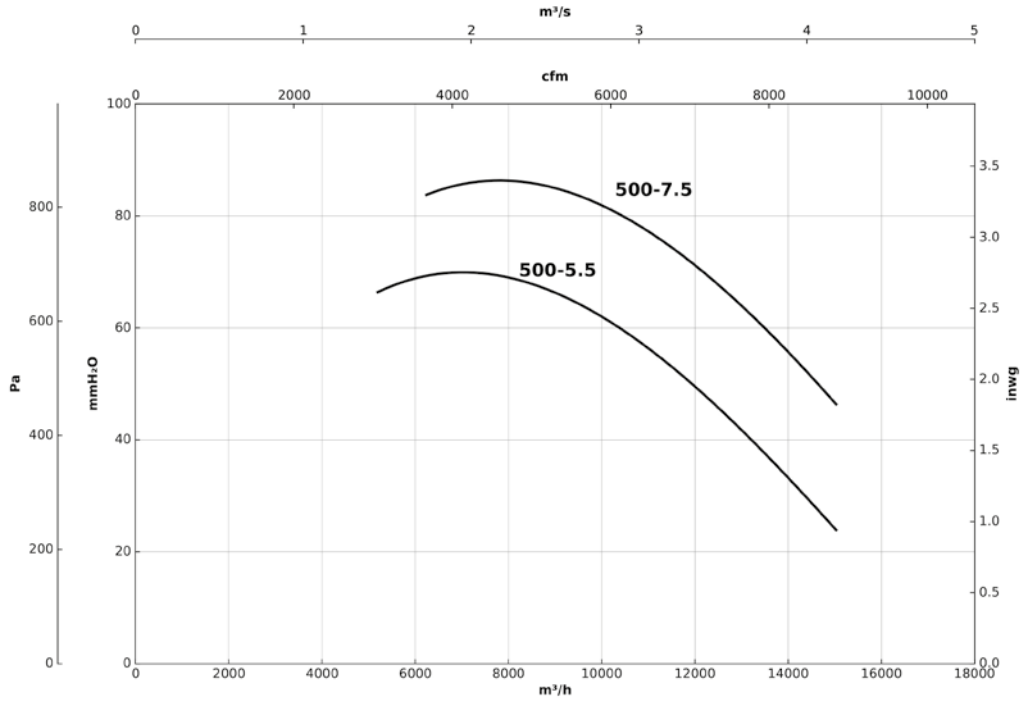

UFRX/ALS PCO -630

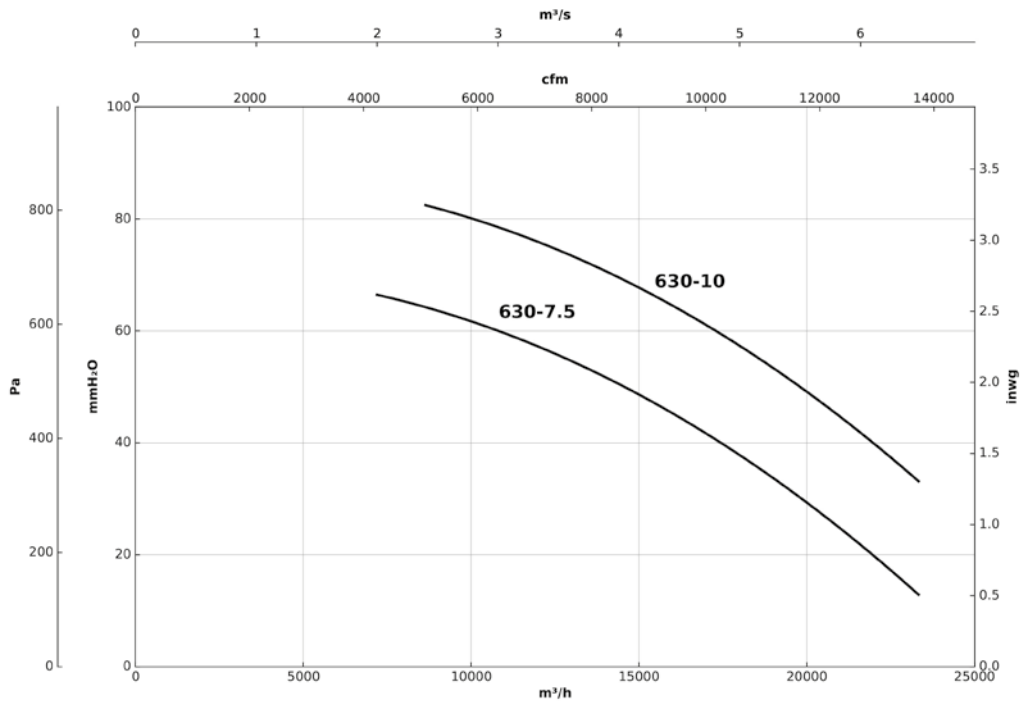

Accessories



INT



RM



VSD3/A-RFT
VSD1/A-RFM



AET



TEJ



VIS



MF



MCA



MFE



MPCO

UFRX/ALS FE

Air purifying units with high efficiency electrostatic filters. For use in applications with greasy particles



Air disinfection, purification and filter units with high efficiency electrostatic filters, specifically designed for cleaning and purifying indoor air in locations that contain a high amount of airborne greasy or suspended particulate matter.

Characteristics:

- Aluminium profile structure.
- Covers with a high quality, 25 mm thick acoustic casing made of prefinished sheet.
- Backward curved impeller.
- High efficiency (95% ePM1) electrostatic filter device with built-in thermal sensor.
- Filtration stages:
 - Washable pre-filter.
 - Electrostatic filter.
 - Active carbon filter.
- Inspection cover for filter maintenance and replacement.

- Grease-collection trays.
- Belt-driven.
- Glands for cable entry.

Motor:

- IE3 efficiency motors.
- Class F motors with ball bearings and IP55 protection.
- Three-phase 230/400 V 50 Hz (up to 4 kW) and 400/690 V 50 Hz (powers greater than 4 kW).
- Maximum temperature of air to be carried: -20 °C +50 °C.

Finish:

- Aluminium profile and prefinished sheet, with 25 mm thick double-wall thermal and acoustic insulation panels.

On request:

- Circular outlet.

Order code



UFRX/ALS FE: Air purifying units with high efficiency electrostatic filters. For use in applications with greasy particles

Impeller diameter in mm

Motor power (HP)

Filter characteristics

ELECTROSTATIC FILTER	ePM ₁				ACTIVE CARBON FILTER	EN 779 Em	EN 1822	ISO 16890				
	95%	90%	80%	70%				ISO ePM ₁	ISO ePM _{2,5}	ISO ePM ₁₀	ISO COARSE	
Filtration class EN 779	-	-	F9	F8	F7	FCA	90%	-	-	-	-	60%
Air speed (m/s)	1	2	2.5	3	4							
Air flow capacity (%)	40	50	65	75	100							
Pressure drop (Pa)	10	17	24	37	64							

Technical characteristics

Model	Speed (r/min)	Maximum admissible current (A)			Installed power (kW)	Minimum recommended flow (m ³ /h)	Maximum flow rate (m ³ /h)		Sound pressure level dB (A)	Air temperature (°C)		Approx. weight (Kg)	According ErP
		230V	400V	690V			Grease particles	Dry particles		min.	max.		
UFRX/ALS FE-355-2 IE3	1700	5.48	3.15	1.50	1920	3675	4900	72	-20	+50	146	2018	
UFRX/ALS FE-355-3 IE3	1930	7.93	4.56	2.20	1920	3675	4900	75	-20	+50	155	2018	
UFRX/ALS FE-400-3 IE3	1620	7.93	4.56	2.20	3360	6300	8400	72	-20	+50	190	2018	
UFRX/ALS FE-400-4 IE3	1820	10.70	6.15	3.00	3360	6300	8400	75	-20	+50	196	2018	
UFRX/ALS FE-450-4 IE3	1510	10.70	6.15	3.00	3600	6990	9320	73	-20	+50	223	2018	
UFRX/ALS FE-450-5.5 IE3	1670	13.90	8.00	4.00	3600	6990	9320	75	-20	+50	235	2018	
UFRX/ALS FE-500-5.5 IE3	1370	13.90	8.00	4.00	5200	10200	13600	73	-20	+50	276	2018	
UFRX/ALS FE-500-7.5 IE3	1510	10.30	5.97	5.50	5200	10200	13600	76	-20	+50	302	2018	
UFRX/ALS FE-630-7.5 IE3	1020	11.20	6.49	5.50	7200	14625	19500	69	-20	+50	459	2018	
UFRX/ALS FE-630-10 IE3	1135	14.80	8.58	7.50	7200	14625	19500	72	-20	+50	479	2018	



Erp. (Energy Related Products)

Information on Directive 2009/125/EC can be downloaded from the SODECA website or the QuickFan selector programme.

Dimensions mm

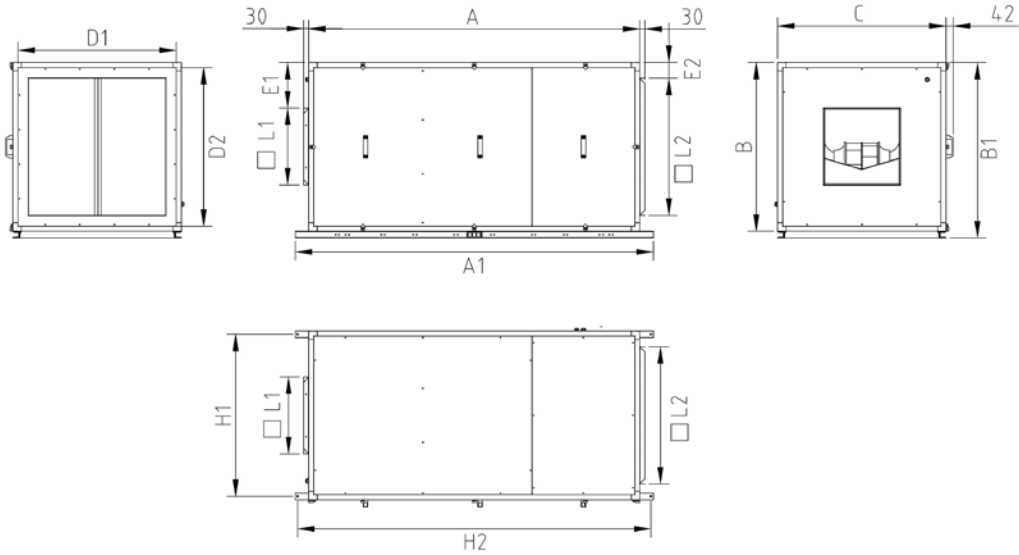

	A	A1	B	B1	C	D1	D2	E1	E2	L1	L2	H1	H2
UFRX/ALS FE 355	2005	2125	1000	1040	1000	940	940	270	90	455	815	960	2095
UFRX/ALS FE 400	2130	2250	1195	1235	1195	1115	1115	365	130	510	930	1155	2220
UFRX/ALS FE 450	2230	2350	1250	1290	1250	1170	1170	330	170	575	910	1210	2320
UFRX/ALS FE 500	2500	2620	1450	1490	1450	1370	1370	340	170	640	1110	1410	2590
UFRX/ALS FE 630	2605	2725	1670	1710	1670	1590	1590	420	140	805	1395	1630	2695

Characteristic curves

Q= Flow rate in m³/h, m³/s and cfm

Pe= Static pressure in mm H₂O, Pa and inwg

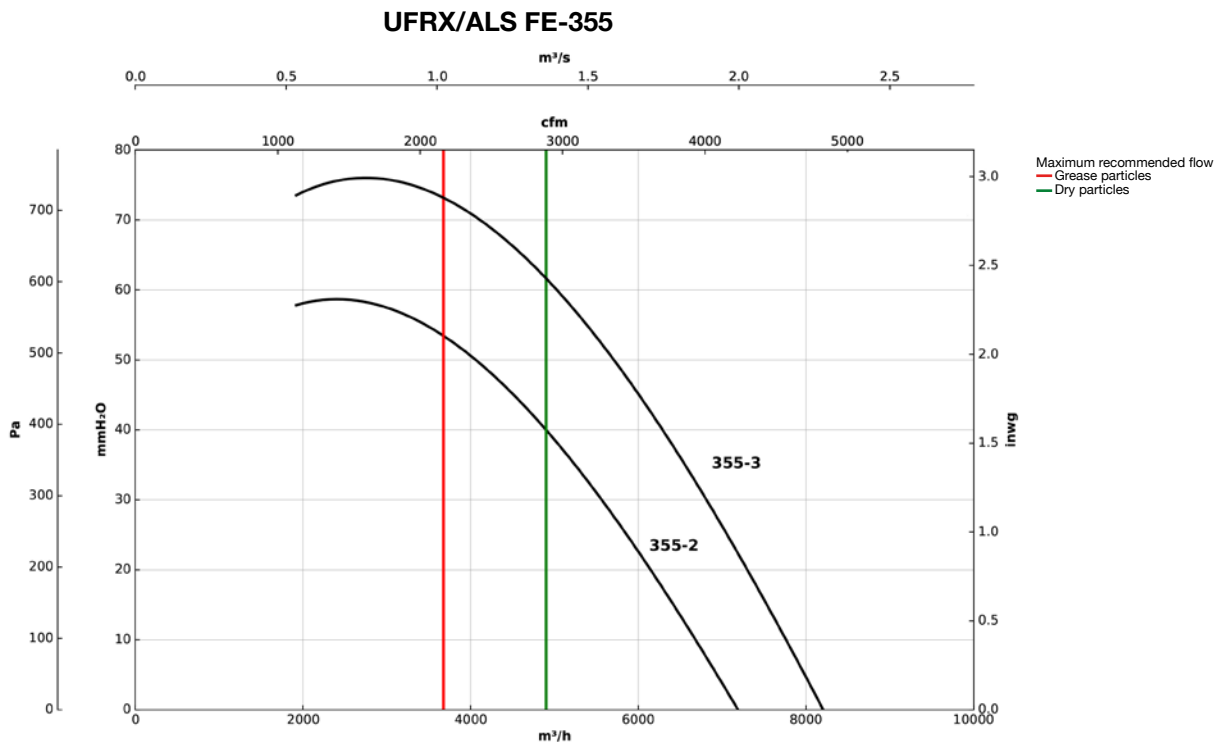

Characteristic curves

Q= Flow rate in m³/h, m³/s and cfm

Pe= Static pressure in mm H₂O, Pa and inwg

UFRX/ALS FE-400

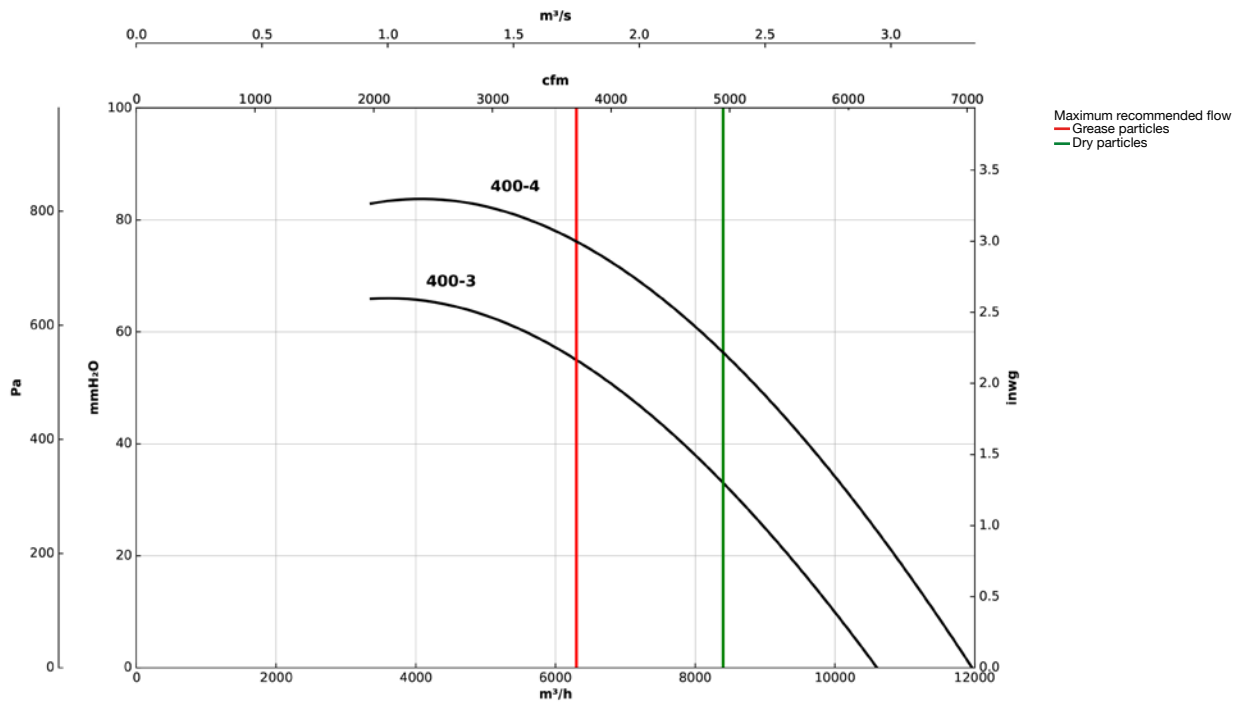

UFRX/ALS FE-450

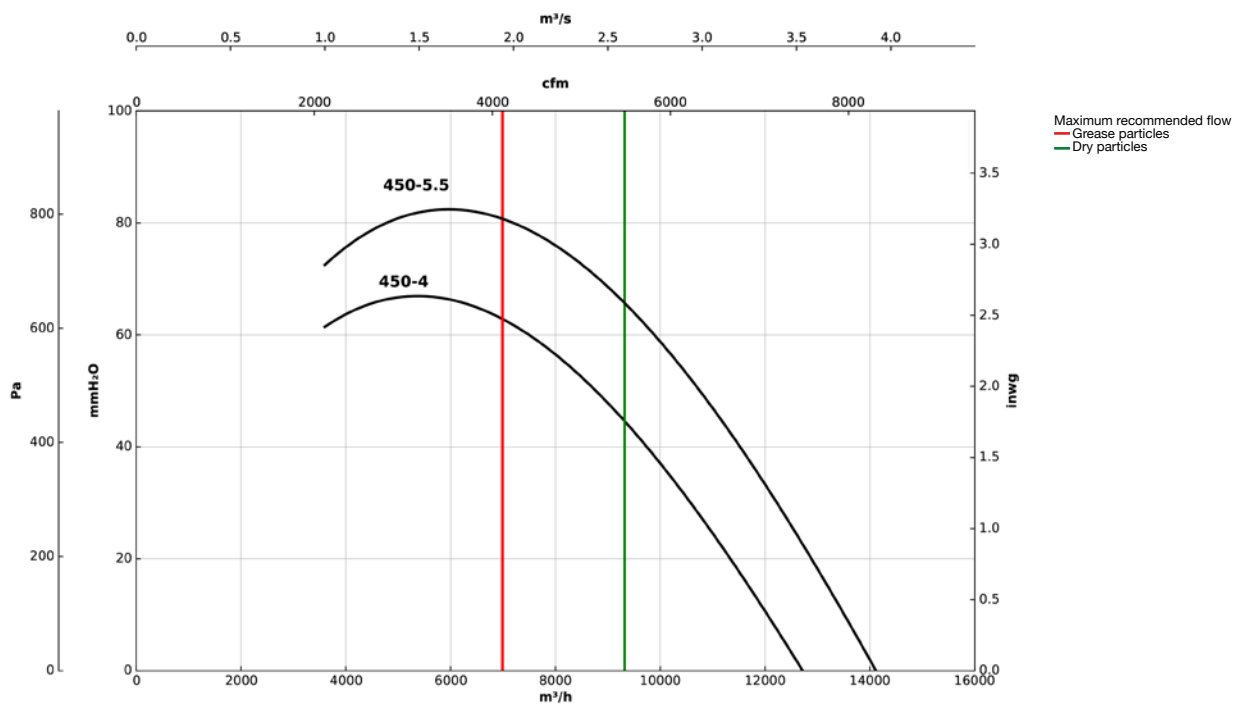

FILTRATION AND DISINFECTION UNITS

Characteristic curves

Q= Flow rate in m³/h, m³/s and cfm

Pe= Static pressure in mm H₂O, Pa and inwg

UFRX/ALS FE-500

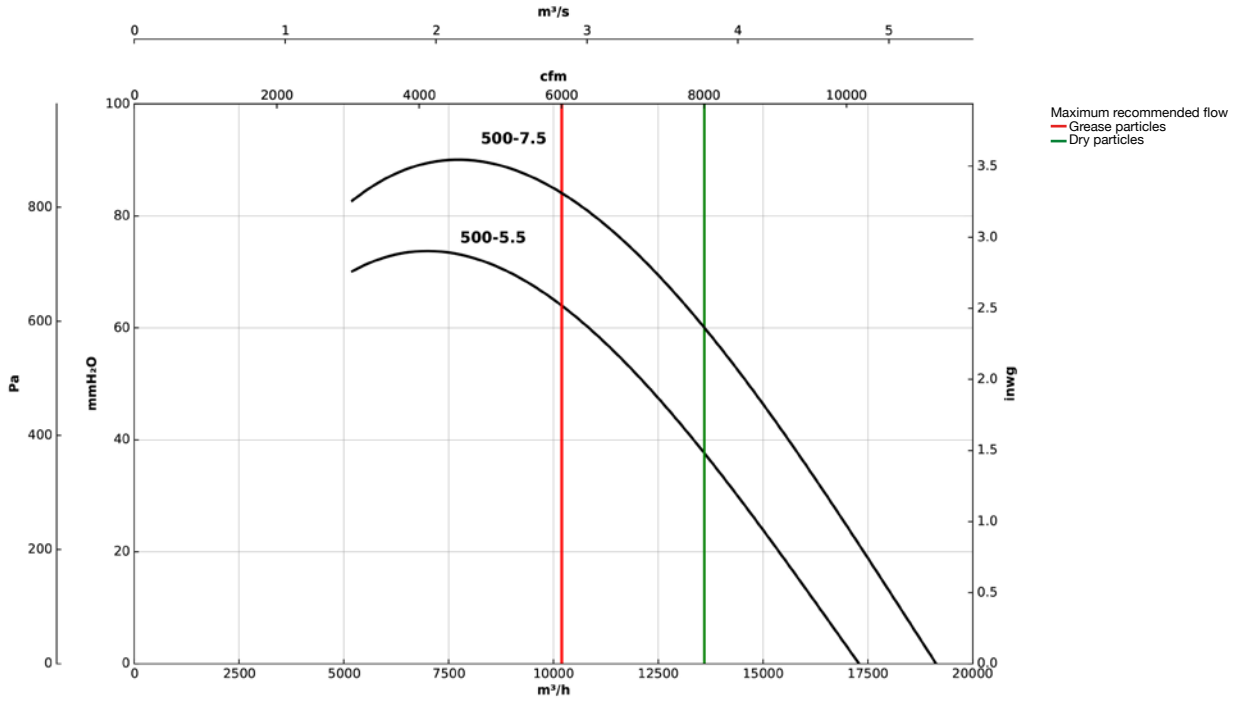

UFRX/ALS FE-630

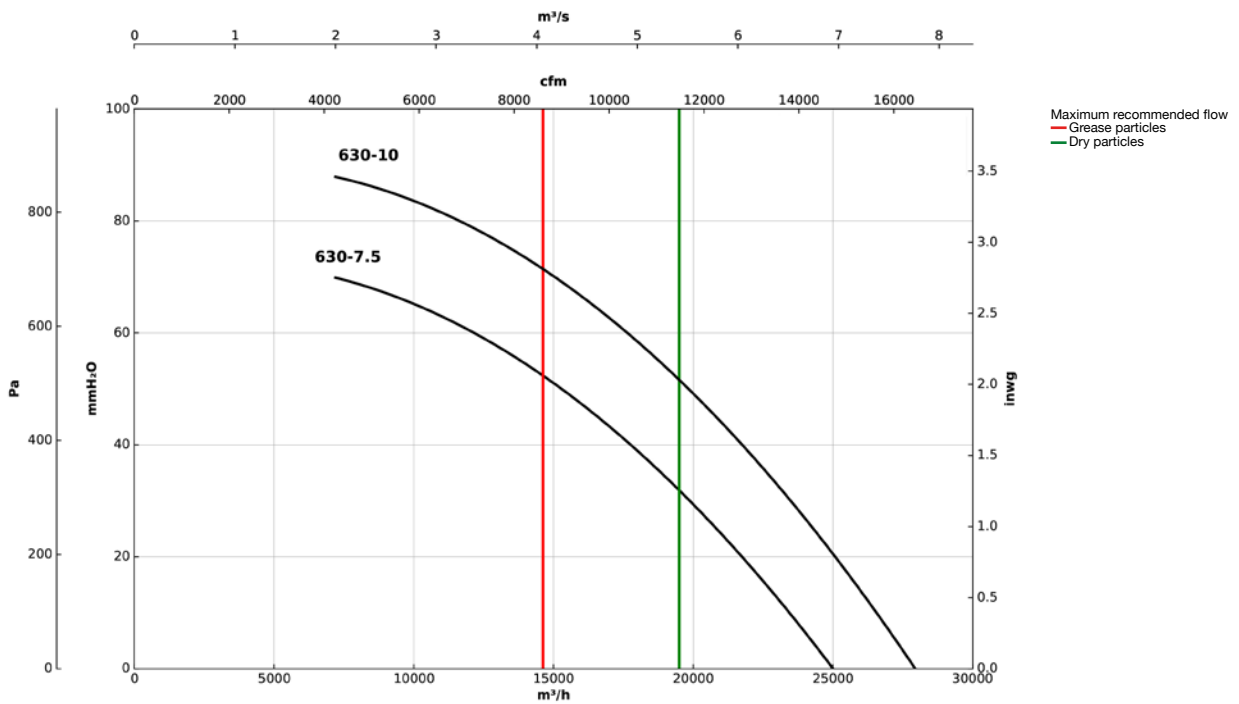

Accessories



UPC/EC PCO

Air purifying units with photocatalysis-based technology

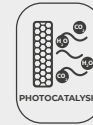

Ventilation and purification units with photocatalysis technology and HEPA filter for cleaning and disinfecting air and surfaces inside any high occupancy area.

Characteristics:

- 40 mm aluminium profile structure.
- Dirty filter monitoring and alarm.
- Covers with a high quality, 25 mm thick acoustic casing made of prefinished sheet.
- Backward curved impeller.
- Built-in photocatalyst device with negative ionisation.
- Filtration stages: F7 + HEPA H14.
- Inspection cover for filter maintenance and replacement.
- Effective for up to 40 linear metres of ducting.

Motor:

- High efficiency EC Technology motors, outer rotor adjustable via 0-10 V signal.
- Single-phase 200-240 V 50/60 Hz and three-phase 380-480 V 50/60 Hz.
- Maximum temperature of air to be carried: -25 °C +60 °C.

Finish:

- Aluminium profile and prefinished sheet steel structure with 25 mm thick thermal and acoustic insulation panels.

On request:

- Particulate matter sensor for automatic control SI-PM2.5+VOC or SI-CO2+VOC.

Order code

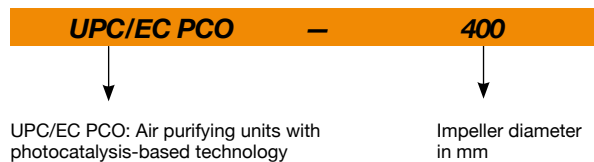

Filter characteristics

STANDARD FILTERS	EN 779 <i>Em</i>	EN 1822	ISO 16890			
			ISO ePM ₁	ISO ePM _{2,5}	ISO ePM ₁₀	ISO COARSE
F7	90%	-	>50%	>65%	>85%	-
H14	-	>99.995%	-	-	-	-

Technical characteristics

Model	Recommended effective working area ¹ (m ²)	Speed (r/min)	Power (W)	Power supply	Sound pressure level at 50% of max speed. ² dB (A)	Maximum flow rate (m ³ /h)	Approx. weight (Kg)
UPC/EC PCO-310	100	2377	450	200-240V 50/60Hz 1Ph	55	800	56
UPC/EC PCO-400	160	1550	460	200-240V 50/60Hz 1Ph	47	1300	98
UPC/EC PCO-500	240	1250	1150	380-480V 50/60Hz 3Ph	51	1950	166

¹Recommended effective working area with a 3-meter-high premises.

² Irradiated sound pressure level in dB(A) at a distance of 3 m.



Erp. (Energy Related Products)

Information on Directive 2009/125/EC can be downloaded from the SODECA website or the QuickFan selector programme.

Dimensions mm

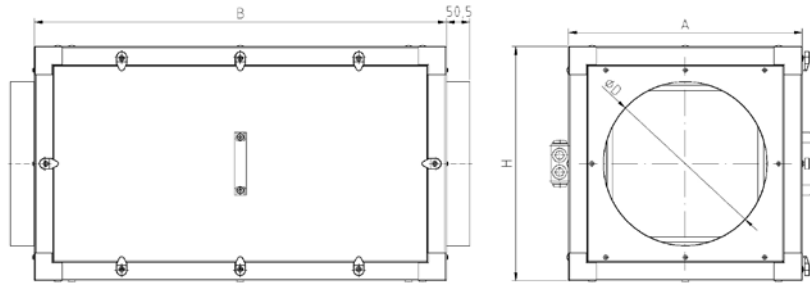

	A	B	H	øD
UPC/EC PCO-310	500	880	500	350
UPC/EC PCO-400	700	1080	700	450
UPC/EC PCO-500	900	1280	900	500

Characteristic curves

Q= Flow rate in m³/h, m³/s and cfm

Pe= Static pressure in mm H₂O, Pa and inwg

UPC/EC PCO -310

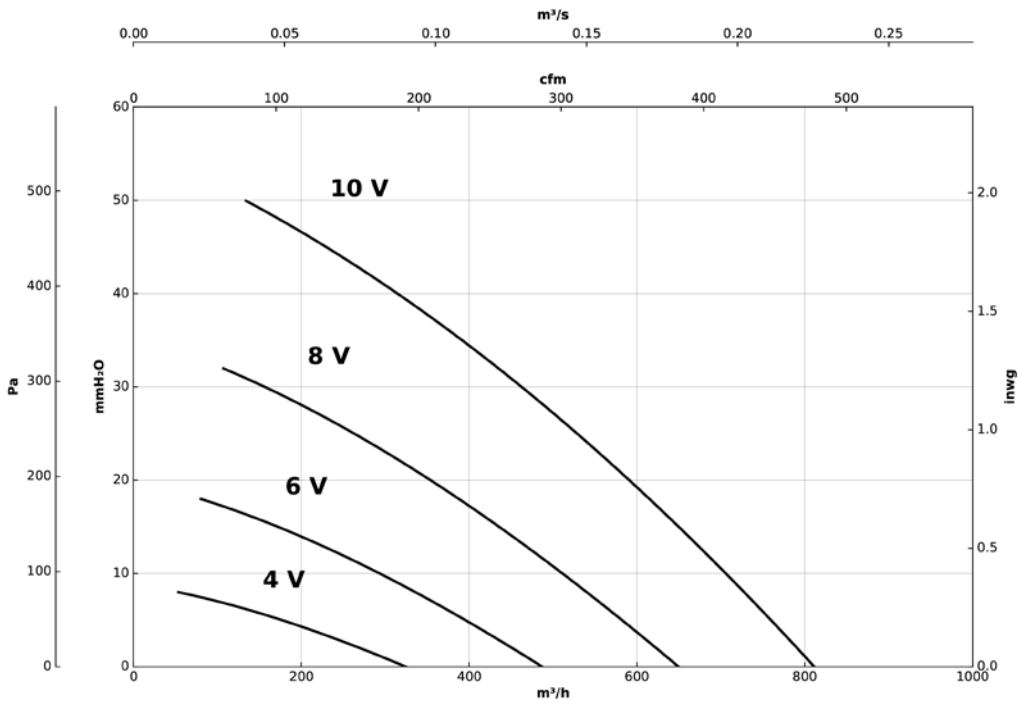

Characteristic curves

Q= Flow rate in m³/h, m³/s and cfm

Pe= Static pressure in mm H₂O, Pa and inwg

UPC/EC PCO -400

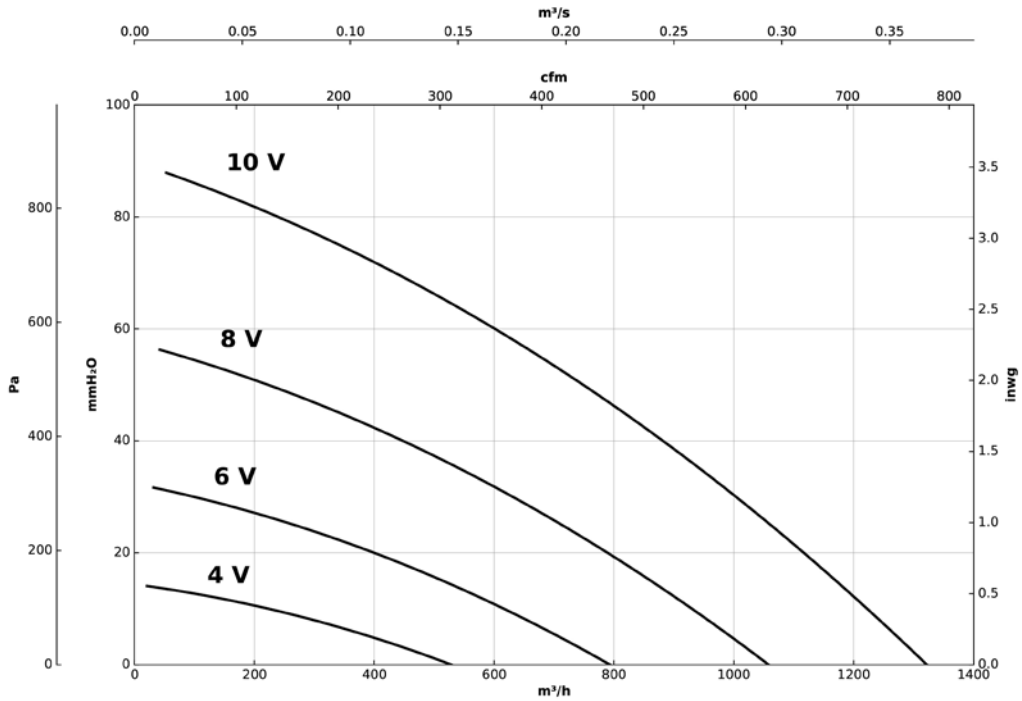

UPC/EC PCO -500

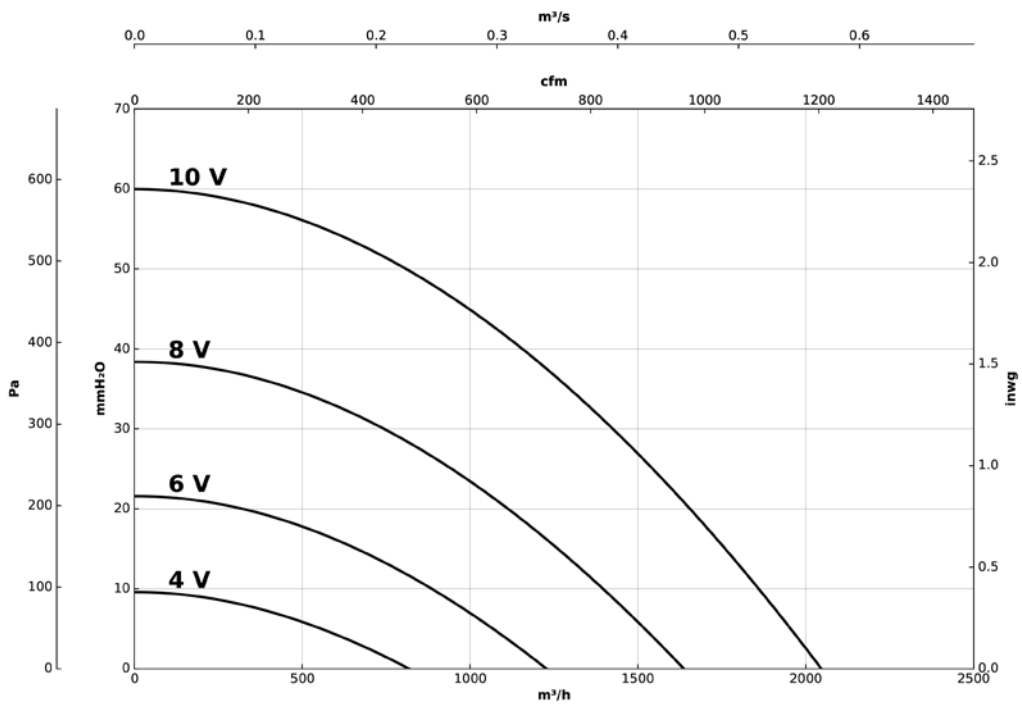

Accessories



UPC/EC FE

Air purifying units with high efficiency electrostatic filters. For use in applications with greasy particles

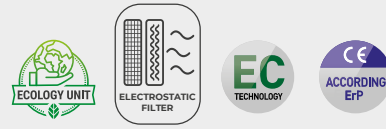

Ventilation and purification units with high efficiency electrostatic filters and active carbon filters that are specifically designed for cleaning air in locations containing a high amount of greasy or suspended particulate matter.

Characteristics:

- 40 mm aluminium profile structure.
- Dirty filter monitoring and alarm.
- Covers with a high quality, 25 mm thick acoustic casing made of prefinished sheet.
- Backward curved impeller.
- Washable pre-filter.
- High efficiency (95% ePM1) electrostatic filter device with built-in thermal sensor.
- Additional active carbon filter stage.
- Inspection cover for filter maintenance and replacement.
- Grease-collection tray.

Motor:

- High efficiency EC Technology motors, outer rotor adjustable via 0-10 V signal.
- Single-phase 200-240 V 50/60 Hz and three-phase 380-480 V 50/60 Hz.
- Maximum temperature of air to be carried: -25 °C +50 °C.

Finish:

- Aluminium profile and prefinished sheet steel structure with 25 mm thick thermal and acoustic insulation panels.

On request:

- Particulate matter sensor for automatic control SI-PM2.5+VOC or SI-CO2+VOC.
- Negative ion ioniser.

Order code

UPC/EC FE – 400

UPC/EC FE: Air purifying units with high efficiency electrostatic filters. For use in applications with greasy particles

Impeller diameter in mm

Filter characteristics

ELECTROSTATIC FILTER	ePM ₁				ACTIVE CARBON FILTER	EN 779 Em	EN 1822	ISO 16890				
	95%	90%	80%	70%				ISO ePM ₁	ISO ePM _{2.5}	ISO ePM ₁₀	ISO COARSE	
Filtration class EN 779	-	-	F9	F8	F7							
Air speed (m/s)	1	2	2.5	3	4							
Air flow capacity (%)	40	50	65	75	100							
Pressure drop (Pa)	10	17	24	37	64							

FCA	90%	-	-	-	-	60%
-----	-----	---	---	---	---	-----

Technical characteristics

Model	Recommended effective working area (m ²) ¹		Speed (r/min)	Power (W)	Power supply	Sound pressure level at 50% of max speed. ² (dB (A))	Maximum flow rate (m ³ /h)		Approx. weight (Kg)
	Grease particles	Dry particles					Grease particles	Dry particles	
UPC/EC FE-310	65	85	1920	175	200-240V 50/60Hz 1Ph	47	525	700	60
UPC/EC FE-400	195	245	1550	460	200-240V 50/60Hz 1Ph	47	1575	2000	111
UPC/EC FE-500	315	385	1250	1150	380-480V 50/60Hz 3Ph	51	2550	3120	184

¹Recommended effective working area with a 3-meter-high premises.

²Irradiated sound pressure level in dB(A) at a distance of 3 m.



Erp. (Energy Related Products)

Information on Directive 2009/125/EC can be downloaded from the SODECA website or the QuickFan selector programme.

Dimensions mm

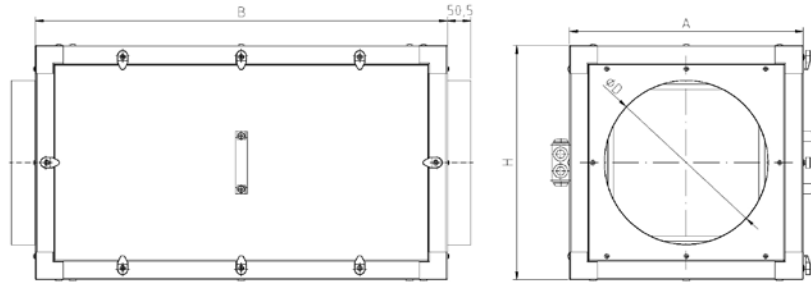

	A	B	H	øD
UPC/EC FE-310	500	880	500	350
UPC/EC FE-400	700	1080	700	450
UPC/EC FE-500	900	1280	900	500

Characteristic curves

Q= Flow rate in m³/h, m³/s and cfm

Pe= Static pressure in mm H₂O, Pa and inwg

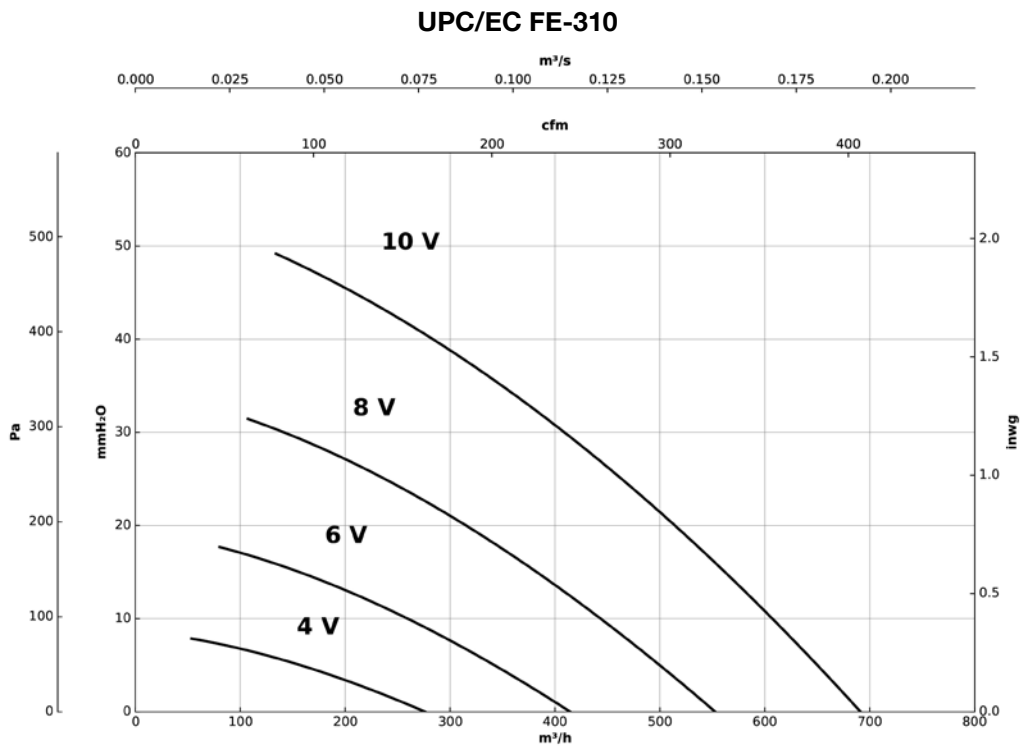

FILTRATION AND DISINFECTION UNITS

Characteristic curves

Q= Flow rate in m³/h, m³/s and cfm

Pe= Static pressure in mm H₂O, Pa and inwg

UPC/EC FE-400

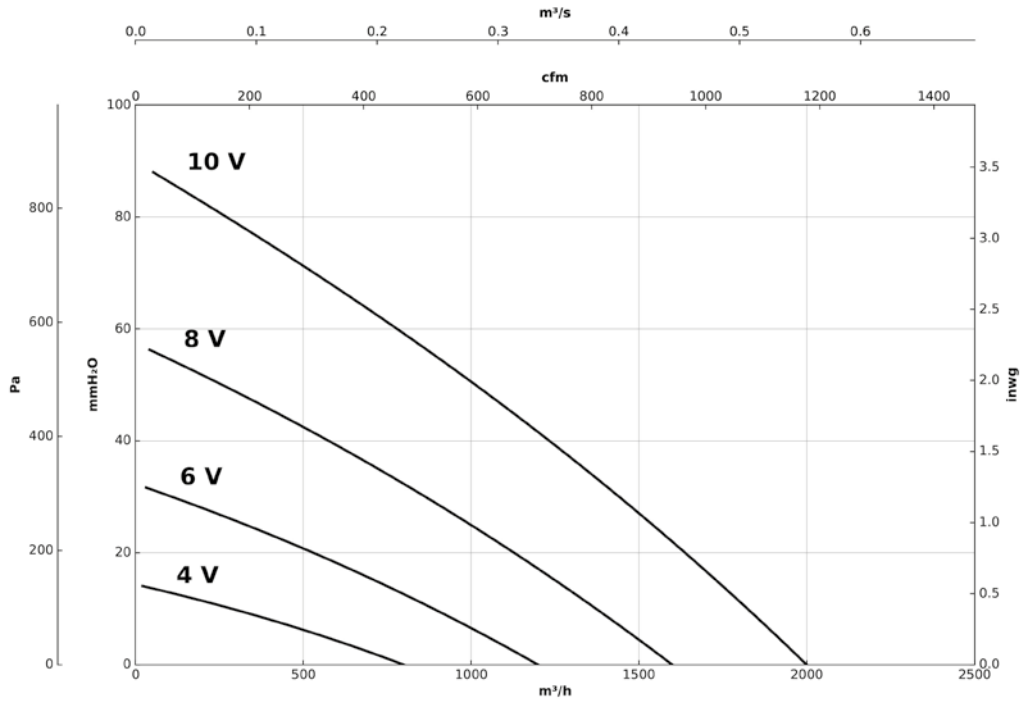

UPC/EC FE-500

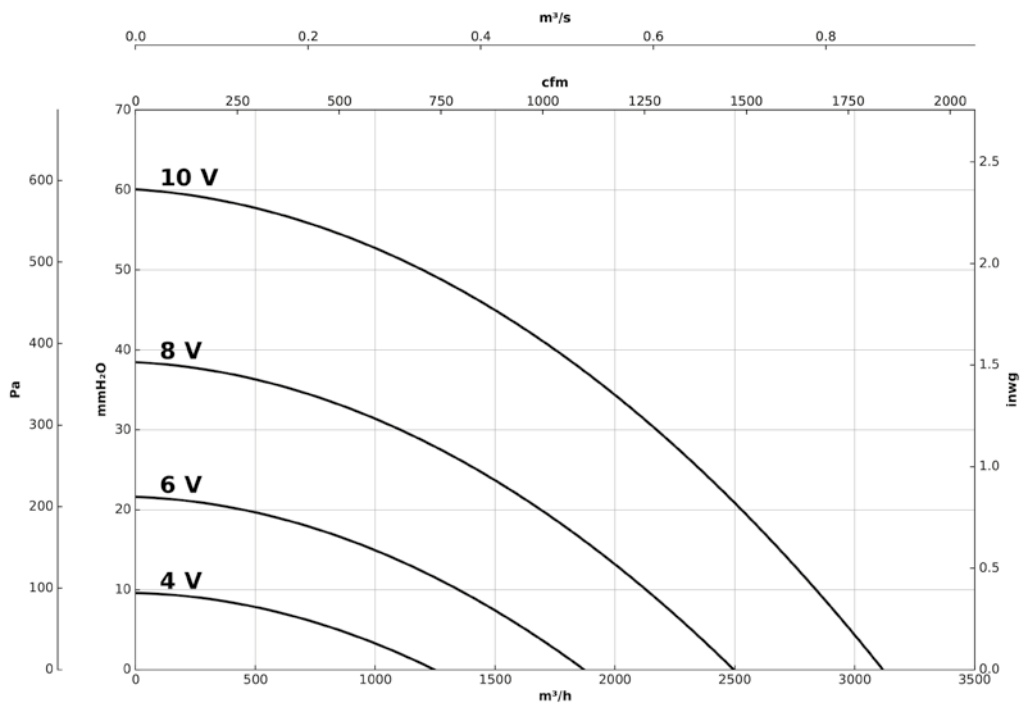

Accessories



MF

MCA

MFE

MPCO

UFR

Acoustically insulated filtration units, backward curved impeller fans with different filtration stages depending on the model

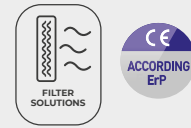

- F6 + F8
- F7 + F9
- G4 + F6

Acoustically insulated filter units with sandwich panel equipped with high performance backward curved impeller fans and different filtration stages depending on the model.

Characteristics:

- Acoustically insulated structure.
- Direct driven.
- Air outlet, configurable on 4 sides.
- F6 + F8, F7 + F9 and G4 + F6 filters, depending on selected model.
- Possibility of pre-filter, plus two filtration stages.
- Easy access inspection and cleaning hatch.
- Pressure taps and pressure switches for filter control.

- High performance backward curved impeller in sheet steel.
- Built-in support bench.

Motor:

- Class F motors with ball bearings and IP55 protection.
- Motors with IE3 efficiency for powers equal to or greater than 0.75 kW, except single-phase, 2-speed and 8-pole.
- Three-phase 230/400 V 50 Hz (up to 4 kW) and 400/690 V 50 Hz (powers greater than 4 kW).
- Temperature of the air to be carried: -20 °C to +60 °C.

Finish:

- Anti-corrosive in galvanized steel sheet.

Construction:

- Galvanised sheet steel structure with acoustic insulation.



Order code



UFR: Acoustically insulated filtration units, backward curved impeller fans with different filtration stages depending on the model

Impeller size

Number of motor poles
4=1400 r/min 50 Hz
6=900 r/min 50 Hz

T = Three-phase

Combination filters

Technical characteristics

Model	Speed (r/min)	Maximum admissible current (A)			Installed power (kW)	Maximum flow rate (m³/h)			N° Pré-filters		N° Filters		Approx. weight (Kg)	According ErP
		230V	400V	690V		Filters (F6+F8)	Filters (F7+F9)	Filters (G4+F6)	Whole*	Medium*	Whole*	Medium*		
UFR-1240-4T IE3	1430	3.34	1.93		0.75	3,245	3,185	3,005	1	0	1	0	107.5	2018
UFR-1850-4T IE3	1420	5.97	3.45		1.50	4,705	4,620	4,350	1	0	1	0	110	2018
UFR-2056-4T IE3	1430	8.38	4.84		2.20	7,680	7,580	7,235	1	2	1	2	168.5	2018
UFR-2056-6T IE3	935	3.77	2.18		0.75	5,325	5,250	5,010	1	2	1	2	163	2018
UFR-2263-4T IE3	1460		11.03	6.37	5.50	11,995	11,680	11,375	1	2	1	2	221.5	2018
UFR-2263-6T IE3	950	5.23	3.02		1.10	7,200	7,100	7,000	1	2	1	2	177.5	2018
UFR-2071-4T IE3	1460		20.64	11.92	11.00	15,045	14,535	14,060	1	2	1	2	265	2018
UFR-2071-6T-3 IE3	940	9.28	5.36		2.20	9,175	8,990	8,810	1	2	1	2	195	2018
UFR-2071-6T-5.5 IE3	970	16.35	9.44		4.00	10,130	9,770	9,440	1	2	1	2	241.5	2018
UFR-2880-6T IE3	970	16.35	9.44		4.00	11,500	11,165	10,845	1	2	1	2	242	2018

*Pre-filter dimensions: Whole: 585x585x48. Medium: 290x585x48

*Filter dimensions: Whole: 593x593x292. Medium: 288x593x292



Erp. (Energy Related Products)

Information on Directive 2009/125/EC can be downloaded from the SODECA website or the QuickFan selector programme.

Dimensions mm

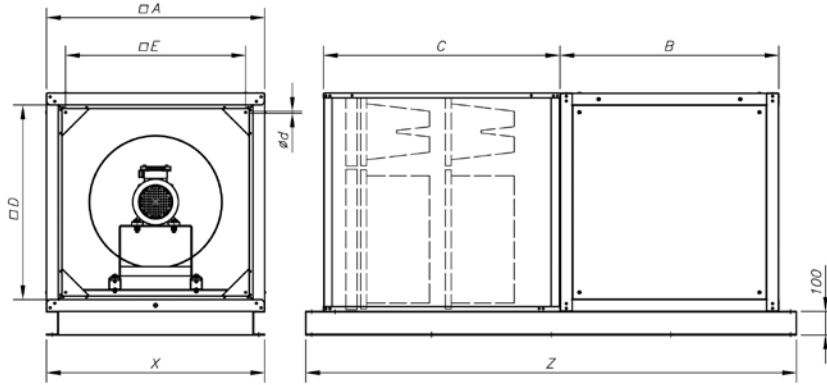

	A	B	C	D	E	Ø d	X	Z
UFR-1240-4T	800	800	950	700	640	M6	800	1906
UFR-1850-4T	800	800	950	700	640	M6	800	1906
UFR-2056-4T	925	925	1000	823	763	M6	925	2081
UFR-2056-6T	925	925	1000	823	763	M6	925	2081
UFR-2263-4T	1000	1000	1000	960	838	M6	1000	2156
UFR-2263-6T	925	925	1000	960	763	M6	925	2081
UFR-2071-4T	1060	1060	1000	960	900	M6	1060	2216
UFR-2071-6T	1000	1000	1000	960	838	M6	1000	2156
UFR-2071-6T-5,5	1060	1060	1000	960	900	M6	1060	2216
UFR-2880-6T	1060	1060	1000	960	900	M6	1060	2216

Characteristic curves

Equipment curve according to built-in filters **1** F6+F8 **2** F7+F9 **3** G4+F6

Static pressure

Dynamic pressure

Absorbed power

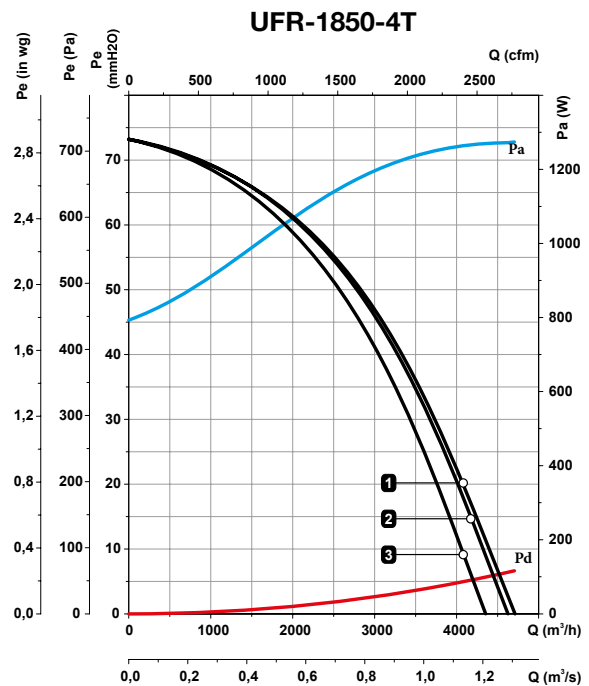
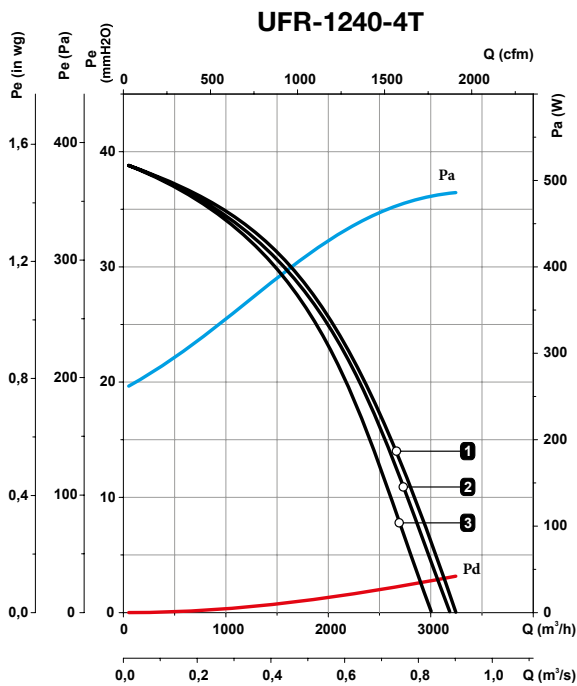

Characteristic curves

Equipment curve according to built-in filters **1** F6+F8 **2** F7+F9 **3** G4+F6

Static pressure

Dynamic pressure

Absorbed power

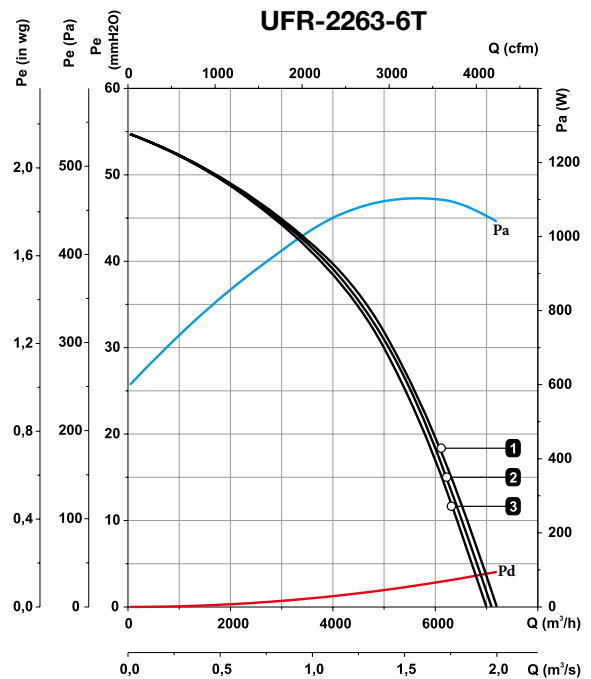
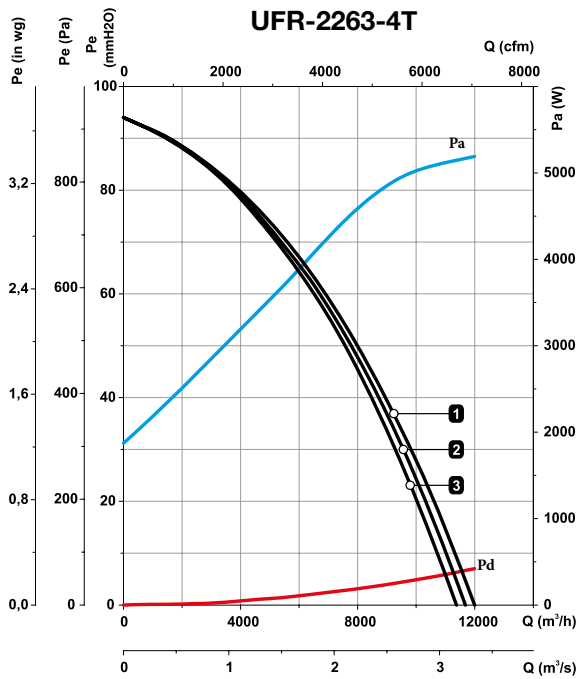
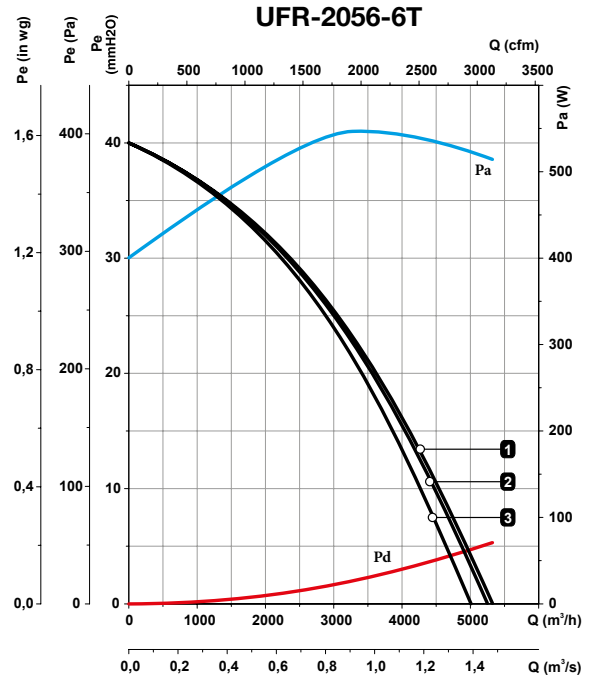
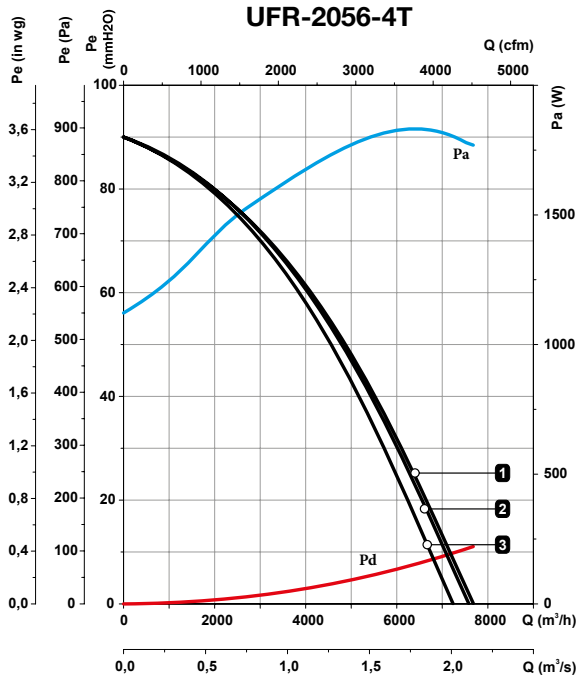

Accessories



FILTROS



CJFILTER



SI-PRESOSTATO



SI-PRESIÓN



KIT CAUDAL
CONSTANTE



SONDA PRESIÓN
DIFERENCIAL



INT



VIS

Characteristic curves

Equipment curve according to built-in filters **1** F6+F8 **2** F7+F9 **3** G4+F6

Static pressure

Dynamic pressure

Absorbed power

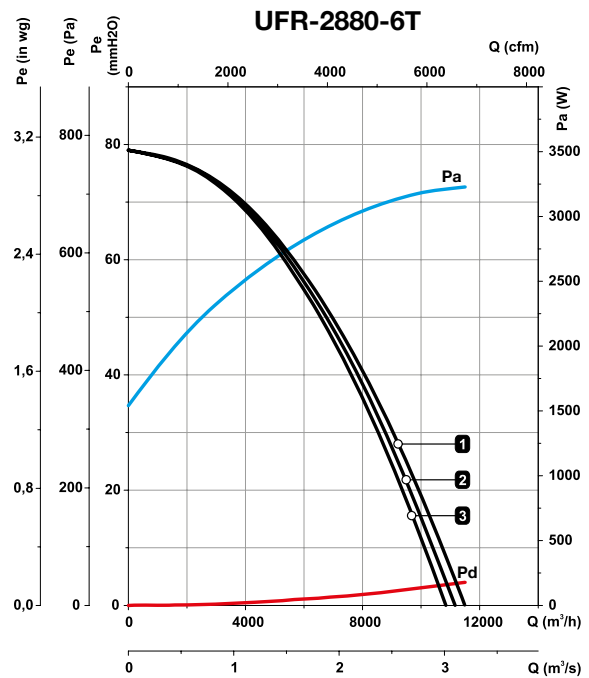
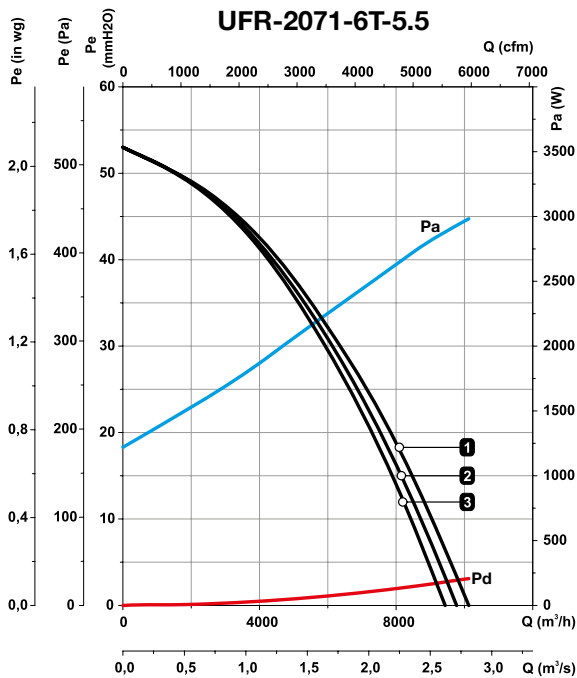
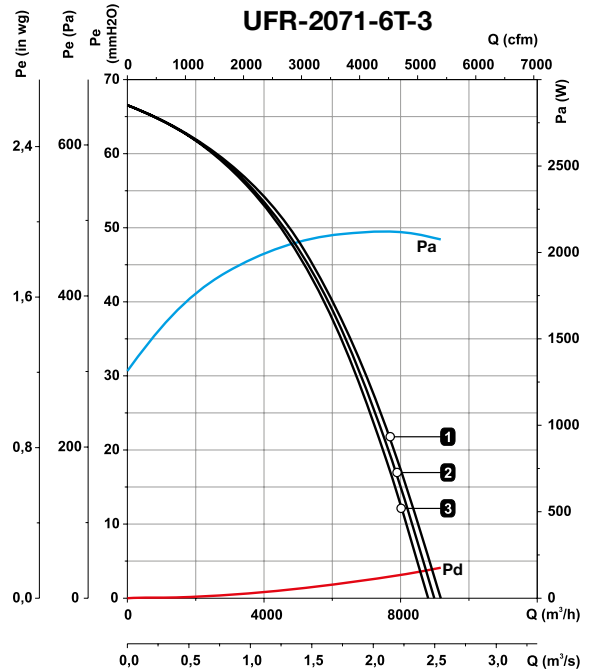
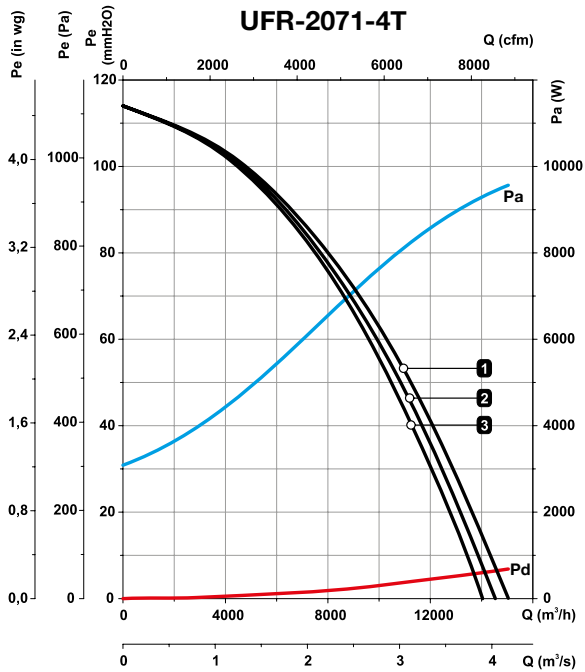

Accessories



TEJ



BS



SB

UFX

Acoustically insulated filtration units, equipped with double inlet fans and different filtration stages depending on the model

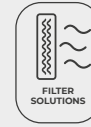

Characteristics:

- Acoustically insulated structure.
- Belt driven.
- F6 + F8, F7 + F9 and G4 + F6 filters, depending on selected model.
- Possibility of pre-filter, plus two filtration stages.
- Easy access inspection and cleaning hatch.
- Pressure taps for filter control.

Construction:

- Galvanised sheet steel structure with acoustic insulation.
- Forward curved impeller in galvanized sheet steel.
- Glands for cable entry.
- Built-in support bench.

Motor:

- Class F motors with ball bearings and IP55 protection.
- Motors with IE3 efficiency for powers equal to or greater than 0.75 kW, except single-phase, 2-speed and 8-pole.
- Three-phase 230/400 V 50 Hz (up to 4 kW) and 400/690 V 50 Hz (powers greater than 4 kW).
- Temperature of the air to be carried: -20 °C to +60 °C.

Finish:

- Anti-corrosive in galvanized steel sheet.

Order code

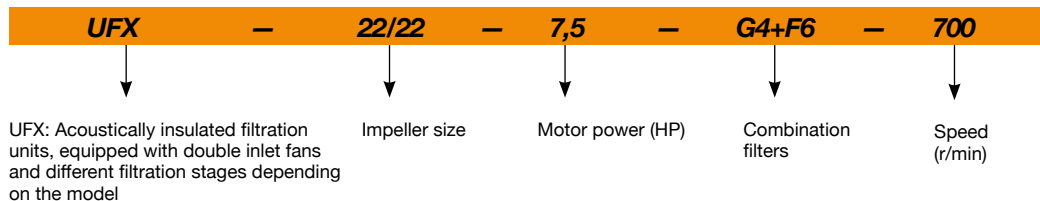

Technical characteristics

Model	Installed power max. (kW)	Maximum flow rate (m ³ /h)			N° Pré-filters		N° Filters		Approx. weight (Kg)	According ErP
		Filters (F6+F8)	Filters (F7+F9)	Filters (G4+F6)	Whole*	Medium*	Whole*	Medium*		
UFX-12/12	2.20	5,250	5,100	4,650	1	0	1	0	112	2018
UFX-15/15	3.00	9,050	8,870	8,225	1	2	1	2	148	2018
UFX-18/18	4.00	10,735	10,370	9,320	1	2	1	2	195.5	2018
UFX-20/20	7.50	16,805	16,510	15,575	4	0	4	0	351.5	2018
UFX-22/22	11.00	21,100	20,610	19,110	4	0	4	0	401	2018
UFX-25/25	11.00	26,760	26,190	24,355	4	4	4	4	457	2018
UFX-30/28	15.00	41,060	40,310	37,840	9	0	9	0	575	2018

*Pre-filter dimensions: Whole: 585x585x48. Medium: 290x585x48

*Filter dimensions: Whole: 593x593x292. Medium: 288x593x292



Erp. (Energy Related Products)

Information on Directive 2009/125/EC can be downloaded from the SODECA website or the QuickFan selector programme.

Dimensions mm

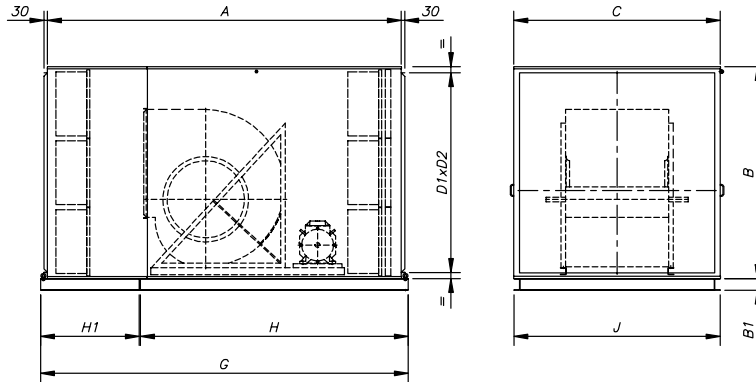

	A	B	C	D1	D2	B1	H	H1	G	J
UFX-12/12	1782	650	700	556	606	60	-	-	1902	698
UFX-15/15	2157.5	932.5	888	826	794	80	1610	657.5	2277.5	886
UFX-18/18	2272.5	932.5	888	826	794	80	1725	657.5	2392.5	886
UFX-20/20	2515	1236.5	1192	1123	1095	80	1855	770	2635	1194
UFX-22/22	2630	1236.5	1192	1123	1095	80	1970	770	2750	1194
UFX-25/25	2827	1524.5	1480	1422	1386	100	2083	854	2947	1478
UFX-30/28	3060	1832.5	1786	1727	1690	100	2316	854	3180	1784

FILTRATION AND DISINFECTION UNITS

Accessories



FILTROS



CJFILTER



SI-PRESOSTATO



SI-PRESIÓN



KIT CAUDAL
CONSTANTE



SONDA PRESIÓN
DIFERENCIAL



INT



VIS



TEJ



SB



BS

EXAMPLE OF SELECTING FILTRATION UNIT UFX

Useful areas according to filters **1** F6+F8 **2** F7+F9 **3** G4+F6

Static pressure Dynamic pressure Sound power dB(A)

Initial data:

- Working flow with clean filters. It is advised to increase the required flow by 10%. In total: 4500 m³/h.
- Head loss from the installation 12 mm H₂O.
- Desired combination of filters: F7+F9.

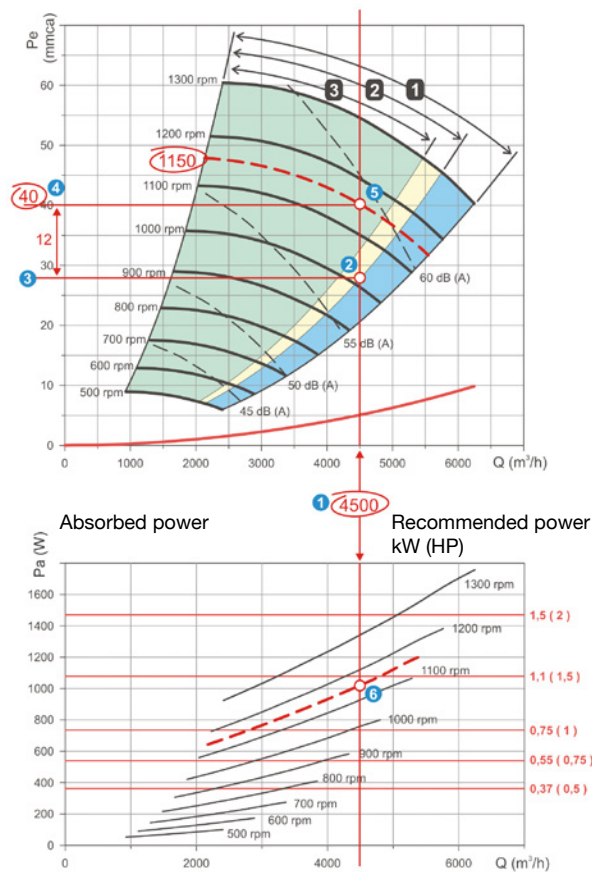

Procedure:

- On the flow-pressure graph, trace a vertical line from the point of 4500 m³/h on the flow (1) axis, through the entire graph, to the point of least pressure of the working area of F7 + F9 (2).

- Trace a horizontal line to the pressure scale (3). The value on the Pe scale is the resistance of the 100% clean filters. In this case, 28 mm H₂O.

- Trace a line parallel to the horizontal line, by adding on the installation's head loss of 12 mm H₂O (4).

- Point (5) is the service point of the equipment, under operating conditions: 4500 m³/h at 40 mm H₂O. It must be checked that the service point is within the useful area of F7+F9. If this is not the case, another piece of equipment must be found.

- The speed of transmission is determined by the position of the service point, between two curves at a known speed. In this case, the result is: 1150 r/min.

- As the filters get dirty, the pressure will increase and the flow will diminish following the curve of: 1150 r/min. The dirty filter must be replaced by a clean one when the flow is reduced to below the acceptable level, or the pressure rises above the maximum indicated on the RITE.

- In the graph of absorbed power, it is possible to find the appropriate motor, tracing a curve of 1150 r/min, between the curves drawn. In the intersection with the flow line, the service point is obtained (6).

- The power immediately above the operating point is: 1,5 CV.

Characteristic curves

Useful areas according to filters **1** F6+F8 **2** F7+F9 **3** G4+F6

Static pressure Dynamic pressure Sound power dB(A)

UFX-12/12

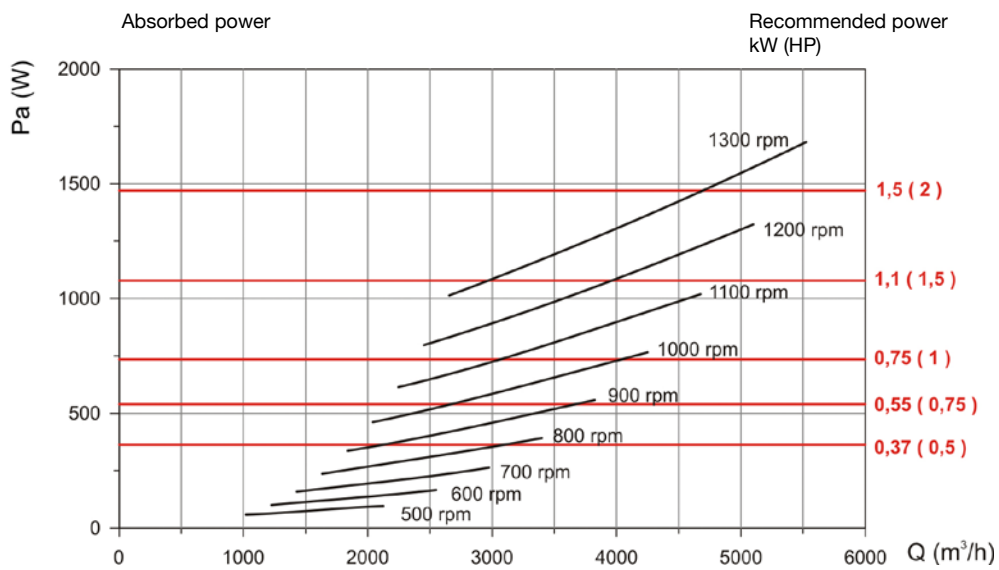
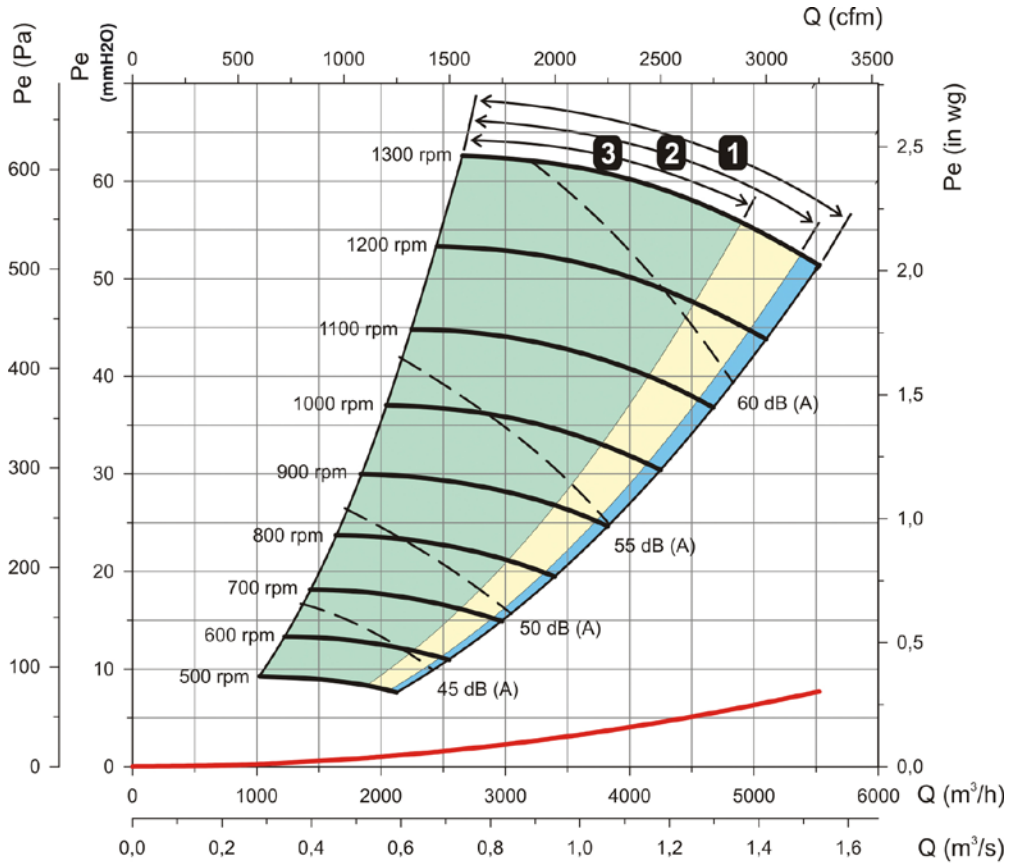

Characteristic curves

Useful areas according to filters **1** F6+F8 **2** F7+F9 **3** G4+F6

Static pressure Dynamic pressure Sound power dB(A)

UFX-15/15

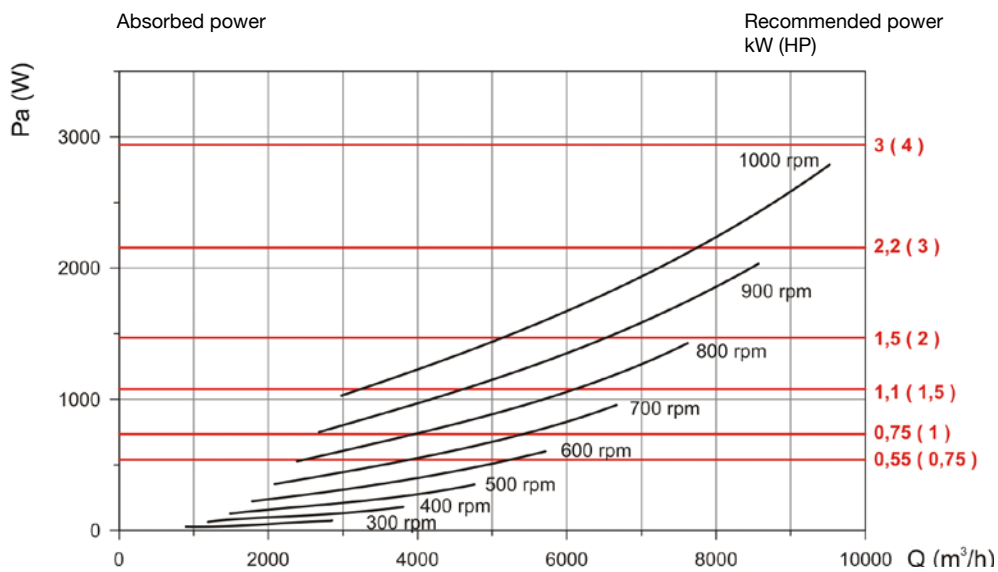
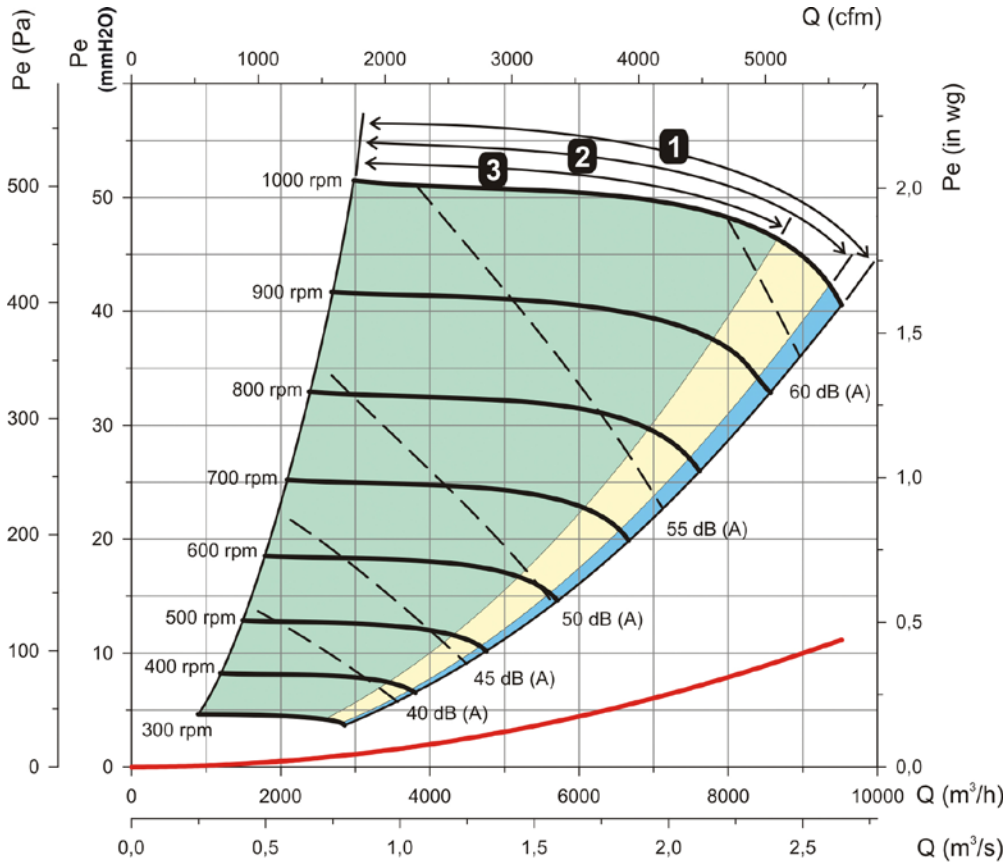

FILTRATION AND DISINFECTION UNITS

Characteristic curves

Useful areas according to filters **1** F6+F8 **2** F7+F9 **3** G4+F6

Static pressure Dynamic pressure Sound power dB(A)

UFX-18/18

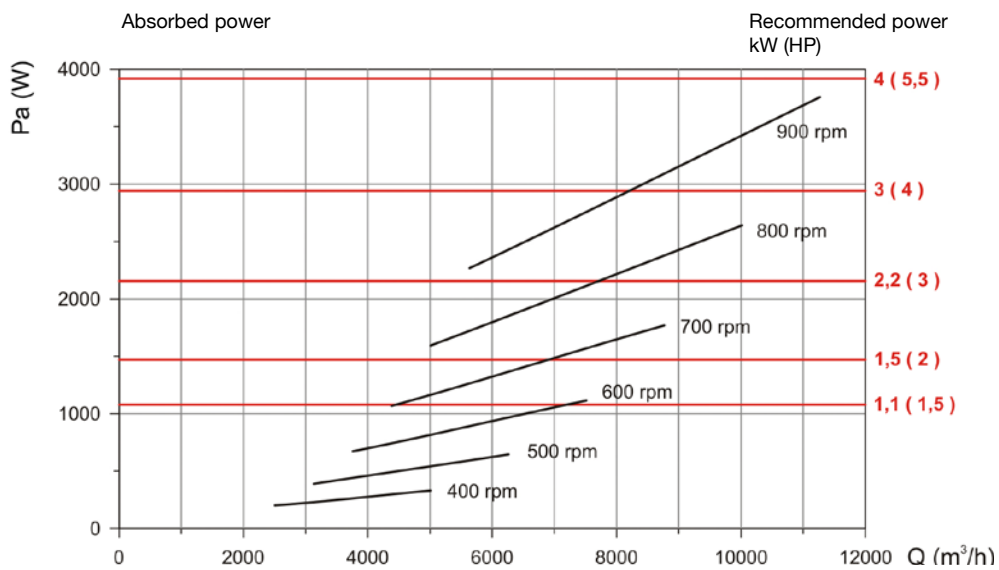
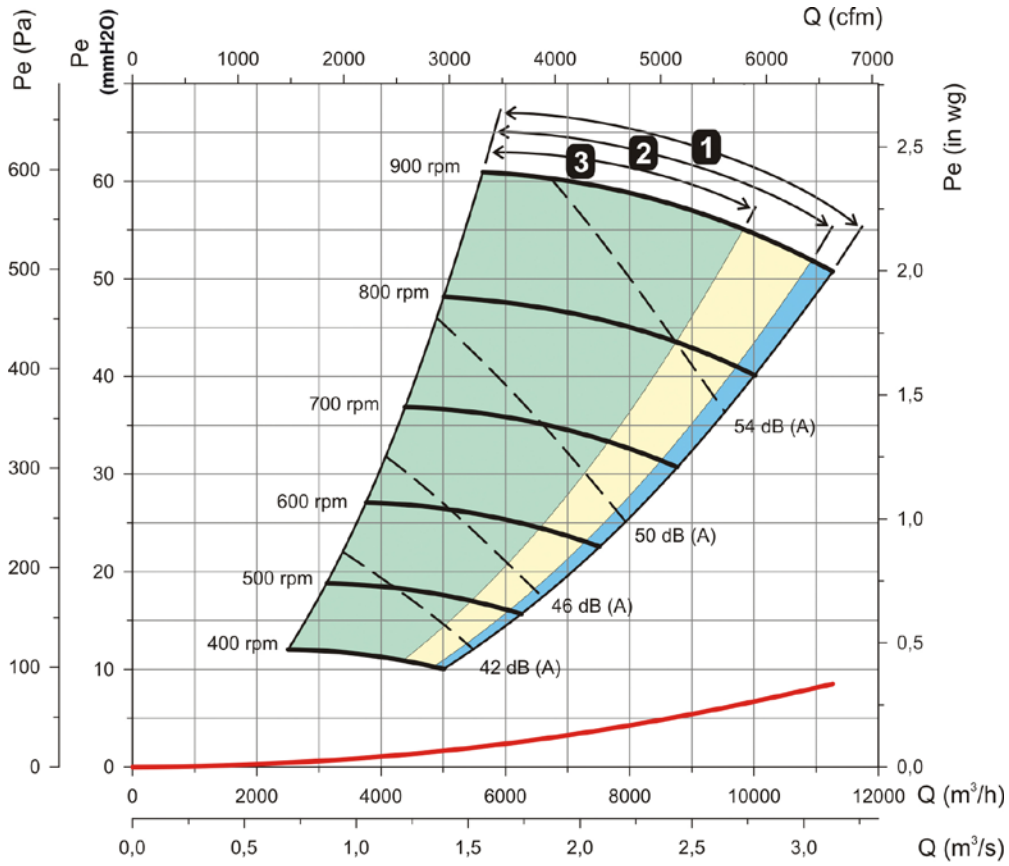

Characteristic curves

Useful areas according to filters **1** F6+F8 **2** F7+F9 **3** G4+F6
 Static pressure Dynamic pressure Sound power dB(A)

UFX-20/20

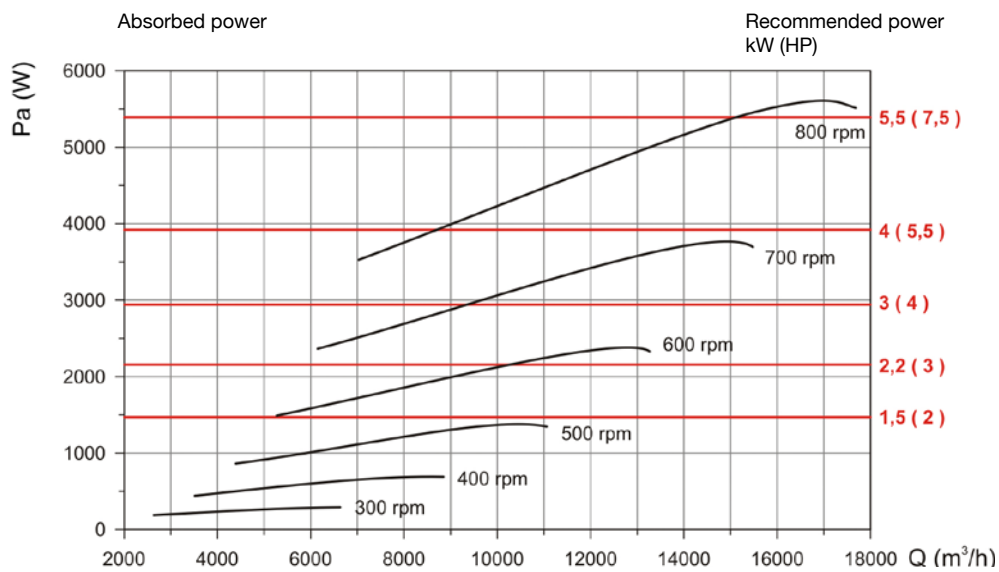
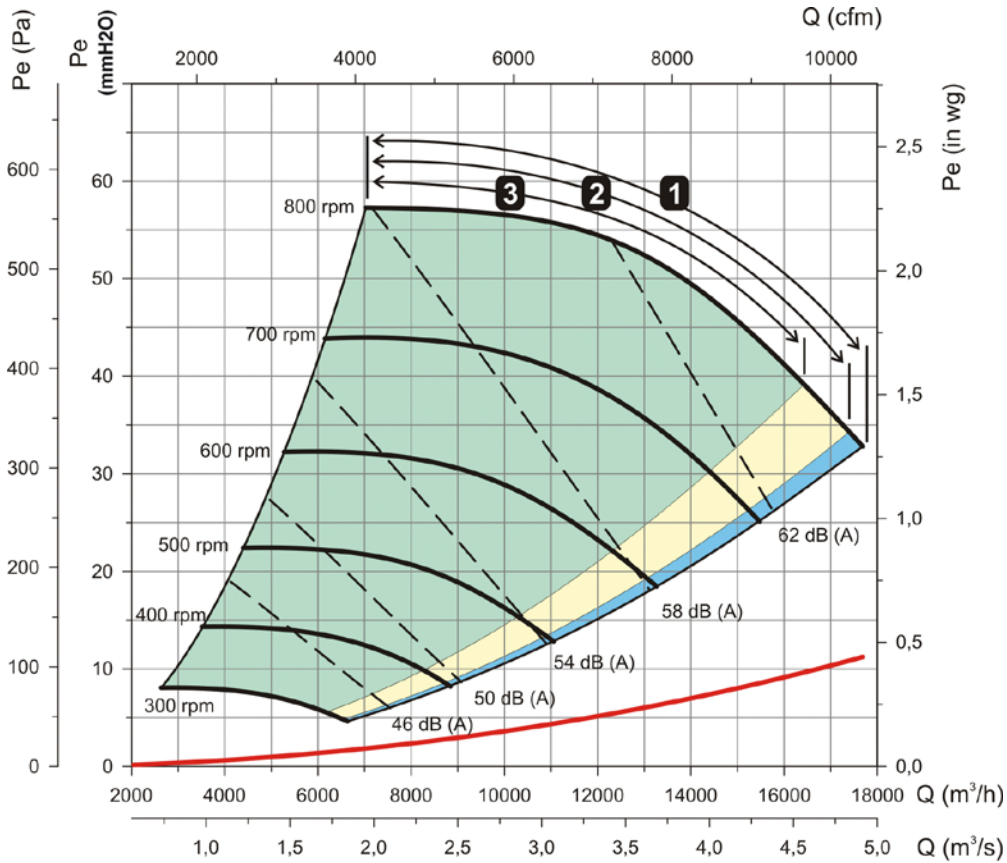

Characteristic curves

Useful areas according to filters **1** F6+F8 **2** F7+F9 **3** G4+F6
 Static pressure Dynamic pressure Sound power dB(A)

UFX-22/22

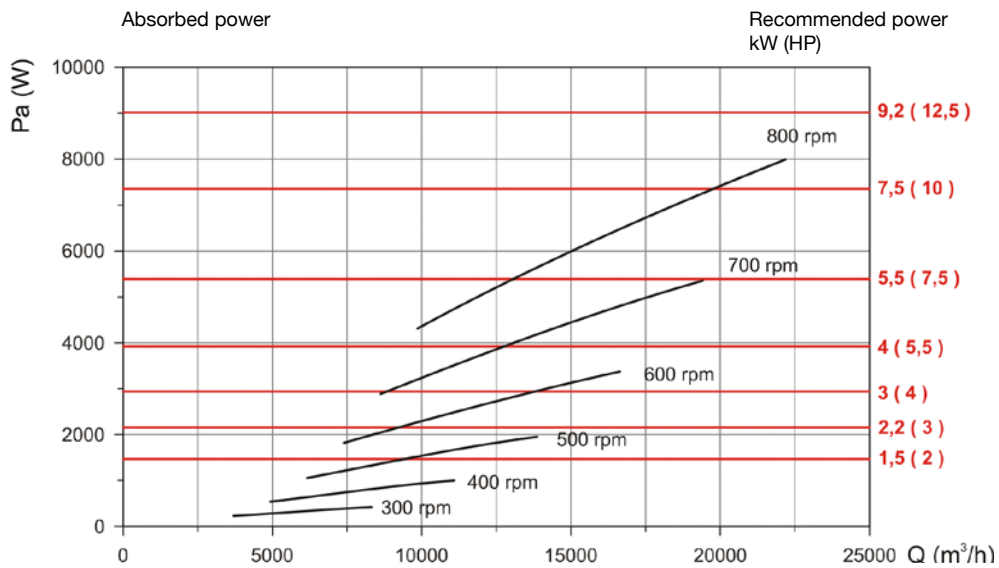
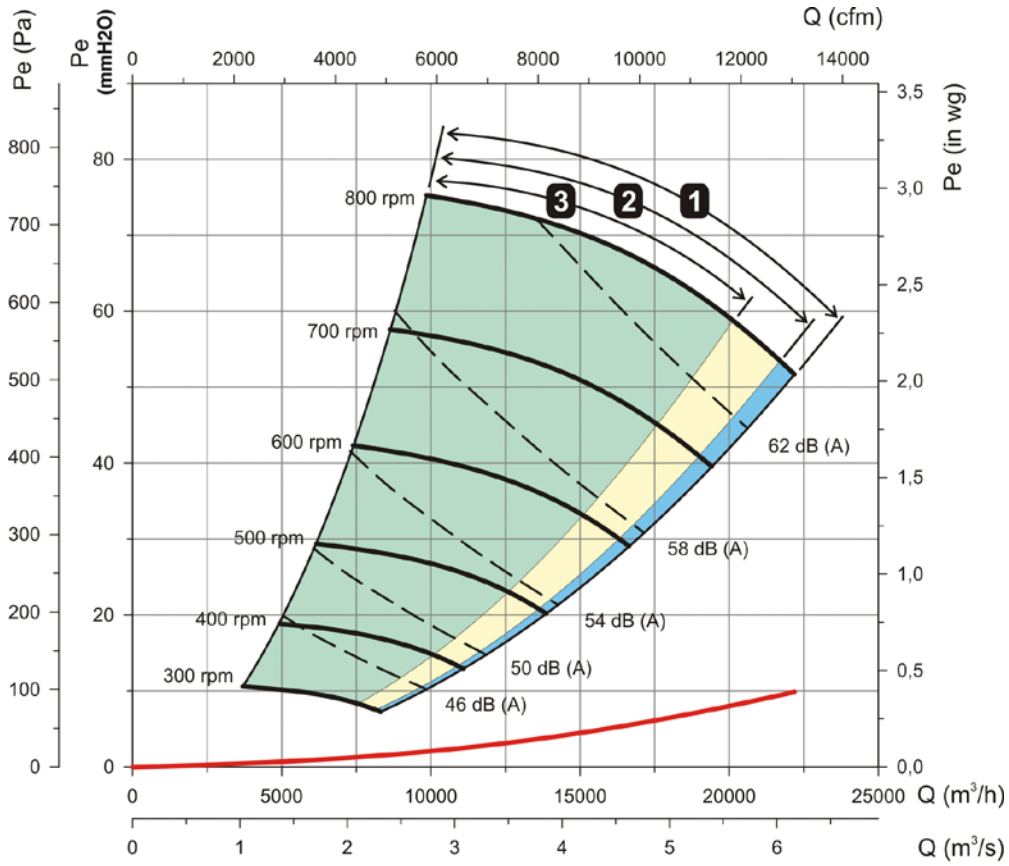

FILTRATION AND DISINFECTION UNITS

Characteristic curves

Useful areas according to filters **1** F6+F8 **2** F7+F9 **3** G4+F6

Static pressure Dynamic pressure Sound power dB(A)

UFX-25/25

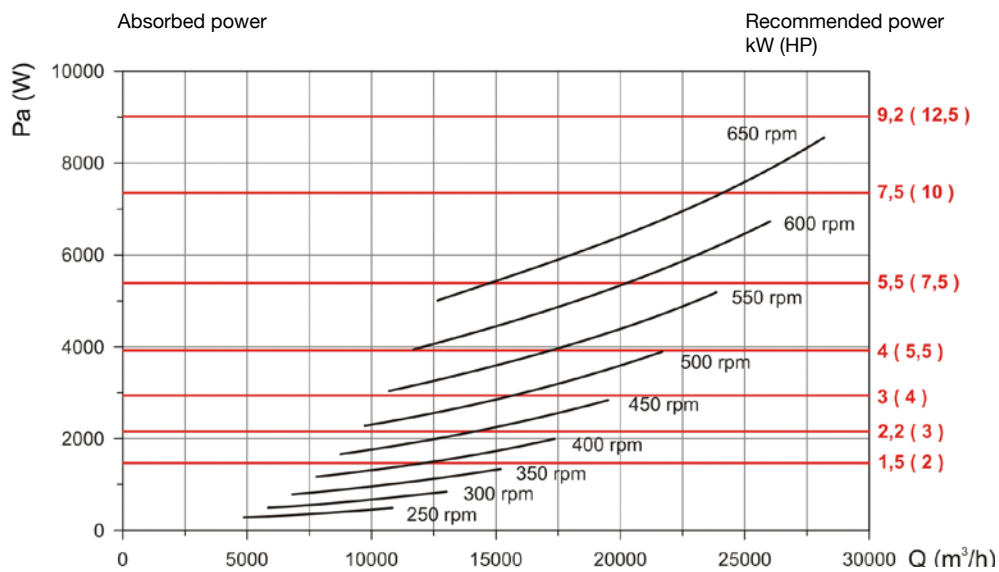
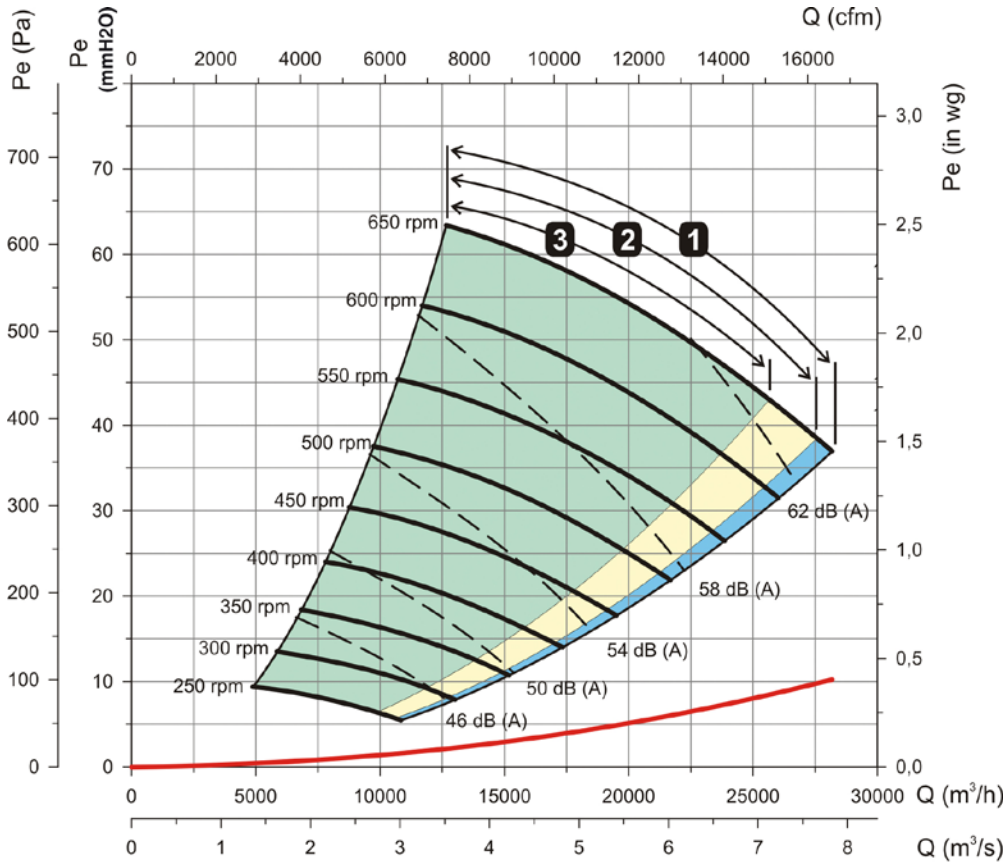

FILTRATION AND DISINFECTION UNITS

Characteristic curves

Useful areas according to filters **1** F6+F8 **2** F7+F9 **3** G4+F6

Static pressure Dynamic pressure Sound power dB(A)

UFX-30/28

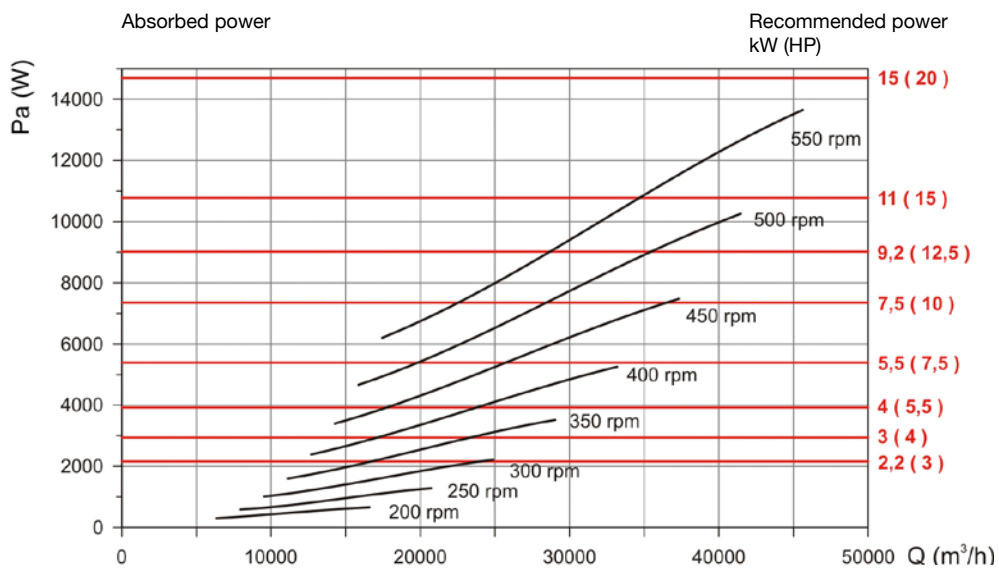
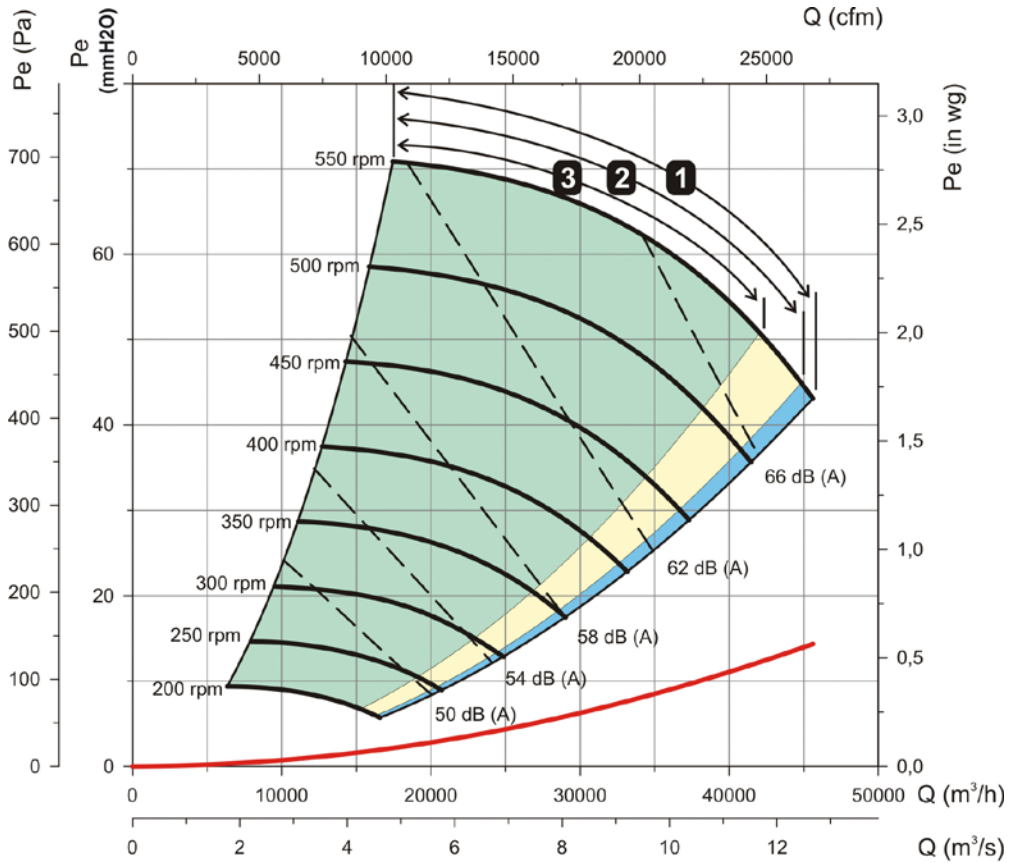

FILTRATION AND DISINFECTION UNITS

UFRX

Acoustically insulated filtration units, highly robust backward curved impeller and different filtration stages depending on the model

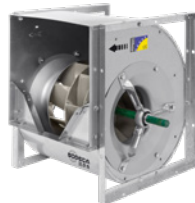
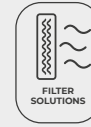

Acoustically insulated filtration units, equipped with highly robust double inlet fans, backward curved impeller and different filtration stages depending on the model.

Characteristics:

- Belt driven.
- Built-in support bench.
- Filters F6 + F8, F7 + F9 and G4 + F6.
- Possibility of pre-filter, plus three stages of filtration.
- Easy access inspection and cleaning hatch.
- Pressure taps and pressure switches for filter control.

Construction:

- Galvanised sheet steel structure with acoustic insulation.

- Backward curved impeller made of sheet steel.
- Built-in support bench.

Motor:

- Class F motors with ball bearings and IP55 protection.
- Motors with IE3 efficiency for powers equal to or greater than 0.75 kW, except single-phase, 2-speed and 8-pole.
- Three-phase 230/400 V 50 Hz (up to 4 kW) and 400/690 V 50 Hz (powers greater than 4 kW).
- Temperature of the air to be carried: -20 °C to +60 °C.

Finish:

- Anti-corrosive in pre-lacquered steel sheet.

Order code

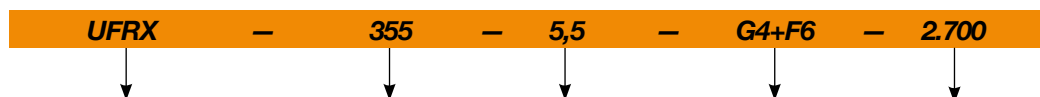

UFRX: Acoustically insulated filtration units, highly robust backward curved impeller and different filtration stages depending on the model

Impeller size

Motor power (HP)

Combination filters

Speed r/min

Technical characteristics

Model	Installed power max. (kW)	Maximum flow rate (m³/h)			N° Pré-filters		N° Filters		Approx. weight (Kg)	According ErP
		Filters (F6+F8)	Filters (F7+F9)	Filters (G4+F6)	Whole*	Medium*	Whole*	Medium*		
UFRX-315	3.0	8,550	8,075	7,600	1	2	1	2	117	2018
UFRX-355	5.5	12,330	11,645	10,960	4	0	4	0	155.5	2018
UFRX-400	7.5	16,470	15,555	14,640	4	0	4	0	204	2018
UFRX-450	11.0	20,700	19,550	18,400	4	4	4	4	364.5	2018
UFRX-500	15.0	28,800	27,200	25,600	4	4	4	4	415	2018
UFRX-560	18.5	36,360	34,340	32,320	9	0	9	0	478	2018
UFRX-630	18.5	43,000	42,000	41,000	9	0	9	0	594	2018

*Pre-filter dimensions: Whole: 585x585x48. Medium: 290x585x48

*Filter dimensions: Whole: 593x593x292. Medium: 288x593x292



Erp. (Energy Related Products)

Information on Directive 2009/125/EC can be downloaded from the SODECA website or the QuickFan selector programme.

Dimensions mm

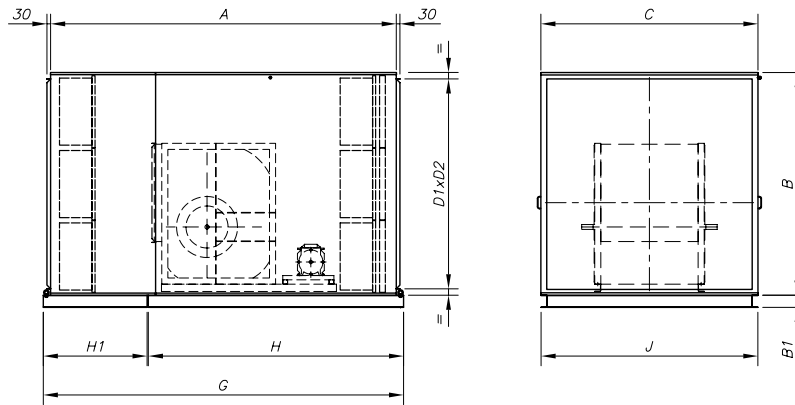

	A	B	C	Height D1	Width D2	B1	H	H1	G	J
UFRX-315	1987.5	932.5	888	826	794	80	1440	657.5	2107.5	886
UFRX-355	2401	1236.5	1192	1123	1095	80	1741	770.5	2521.5	1194
UFRX-400	2401	1236.5	1192	1123	1095	80	1741	770.5	2521.5	1194
UFRX-450	2485	1551.5	1480	1422	1386	100	1741	854	2605.5	1478
UFRX-500	2725	1551.5	1480	1422	1386	100	1981	854	2845.5	1478
UFRX-560	2844	1855.5	1786	1727	1690	100	2100	854	2964.5	1784
UFRX-630	2844	1855.5	1786	1727	1690	100	2100	854	2964.5	1784

Accessories



EXAMPLE OF SELECTING FILTRATION UNIT UFRX

Useful areas according to filter **1** **F6+F8** **2** **F7+8** **3** **G4+F6**

Static pressure Dynamic pressure Sound power dB(A) - - - - -

Initial data:

- Working flow with clean filters. It is advised to increase the required flow by 10%. In total: 7000 m³/h.
- Head loss from the installation 72 mmH₂O.
- Desired combination of filters: F6+F8.

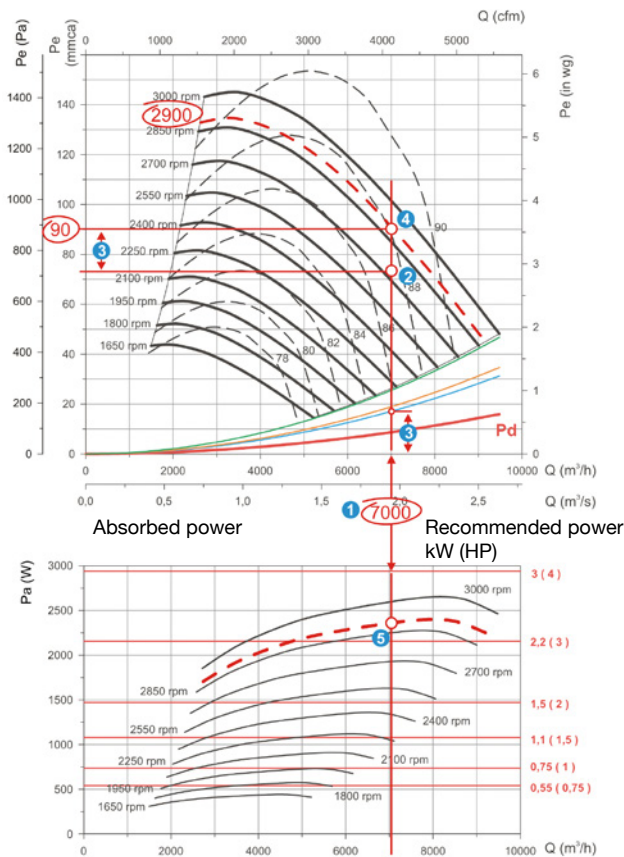

Procedure:

- On the flow-pressure graph, trace a vertical line from the point of 7000 m³/h on the flow (1) axis, through the entire graph, to the working pressure of the installation (2)
- At point (2) add the head loss from the F6+F8 filters, in this case 18 mm H₂O. (3), obtaining point (4). The head loss from the 100% clean filters is taken into account.
- The resulting Point (4) is the service point of the equipment, under operating conditions: 7000 m³/h at 90 mm H₂O. Check that the service point is within the useful area of F7+F9. If this is not the case, another piece of equipment must be found.
- The speed of transmission is determined by the position of the service point, between two curves at a known speed. In this case, the result is: 2900 r/min.
- As the filters get dirty, the pressure will increase and the flow will diminish following the curve of: 2900 r/min. The dirty filter must be replaced by a clean one when the flow is reduced to below the acceptable level, or the pressure rises above the maximum indicated on the RITE.
- In the graph of absorbed power, it is possible to find the appropriate motor, tracing a curve of 2900 r/min, between the curves drawn. In the intersection with the flow line, the service point is obtained (5).
- The recommended power is immediately above the operating point, 4 HP in the example.

Characteristic curves

Useful areas according to filter **1** F6+F**2** F7+**3** G4+F6
 Static pressure Dynamic pressure Sound power dB(A)

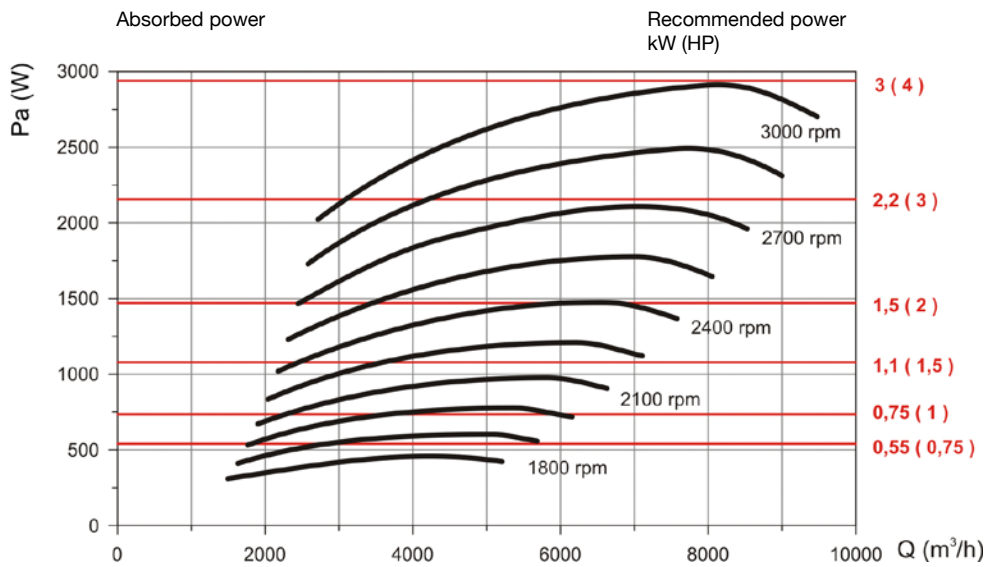
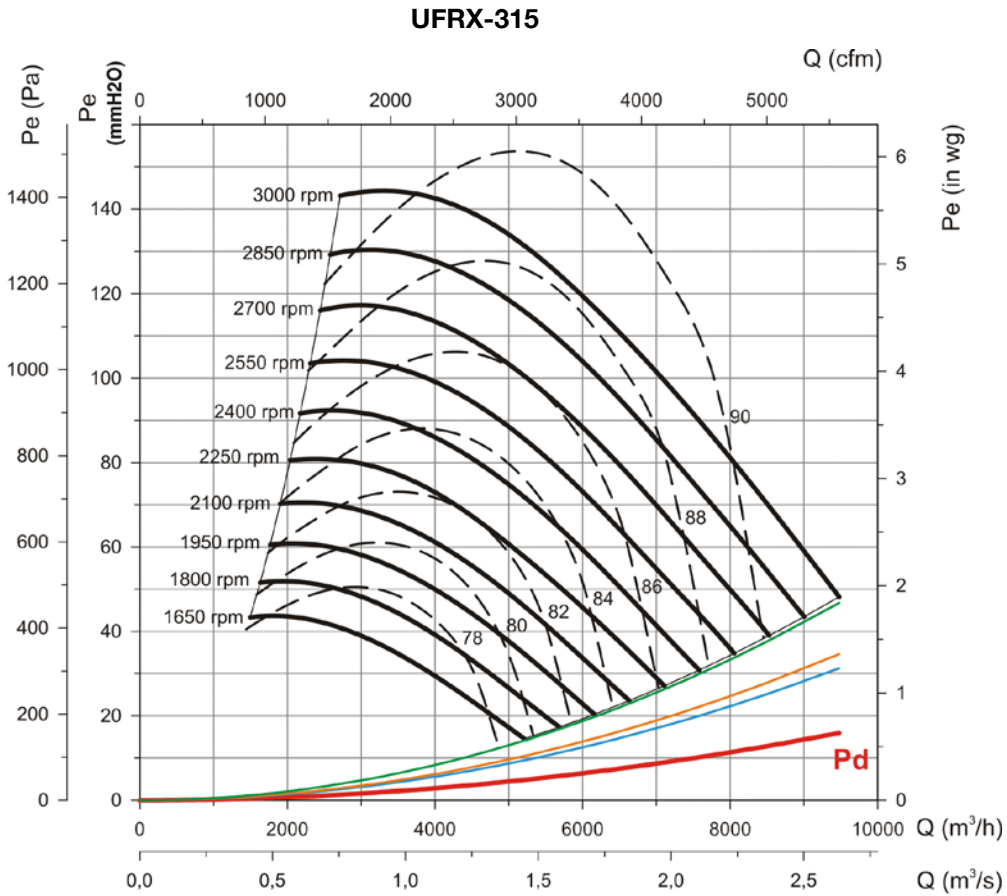

FILTRATION AND DISINFECTION UNITS

Characteristic curves

Useful areas according to filter **1** **F6+F2** **F7+3** **G4+F6**
 Static pressure Dynamic pressure Sound power dB(A) - - - - -

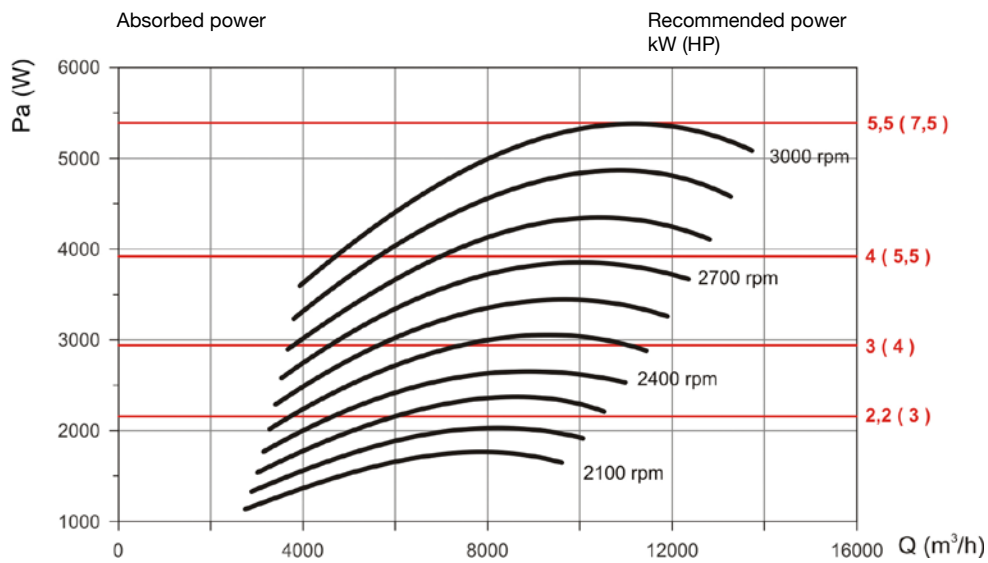
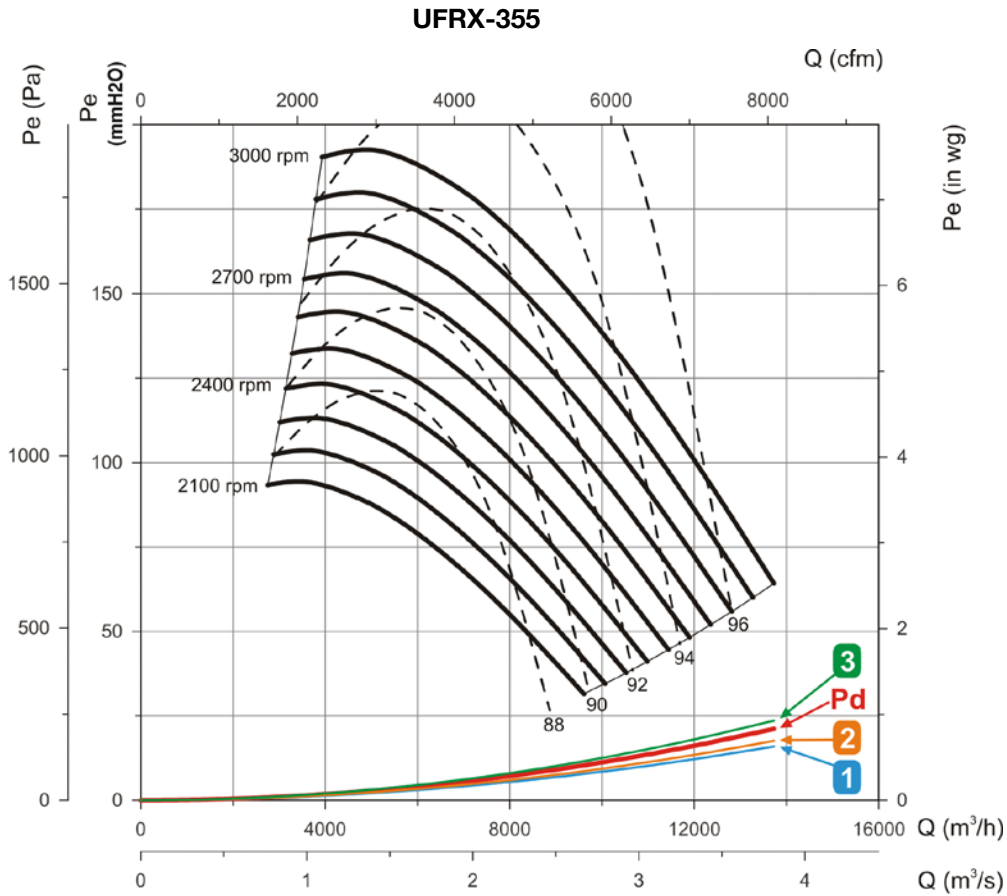

Characteristic curves

Useful areas according to filter **1** F6+F**2** F7+**3** G4+F6
 Static pressure Dynamic pressure Sound power dB(A)

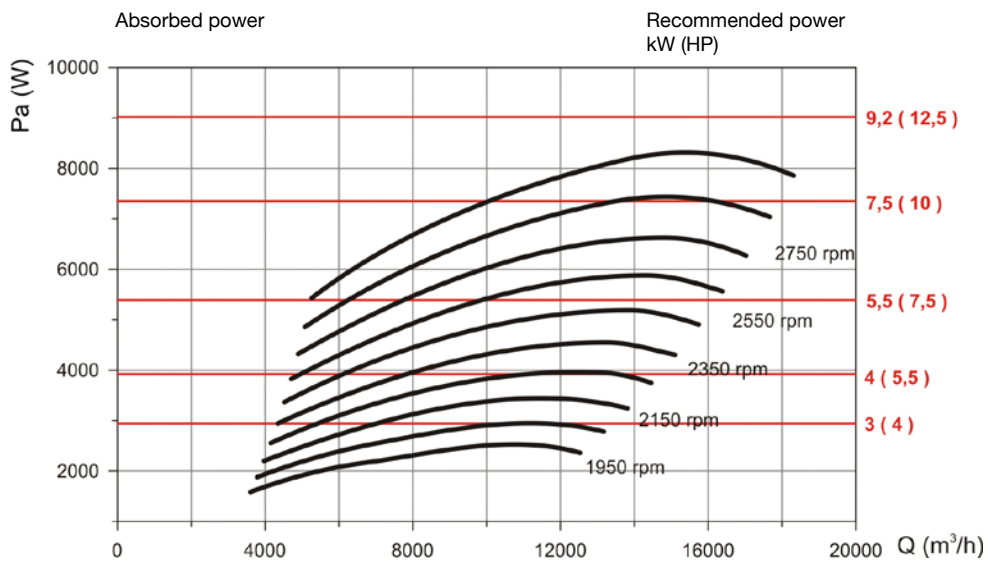
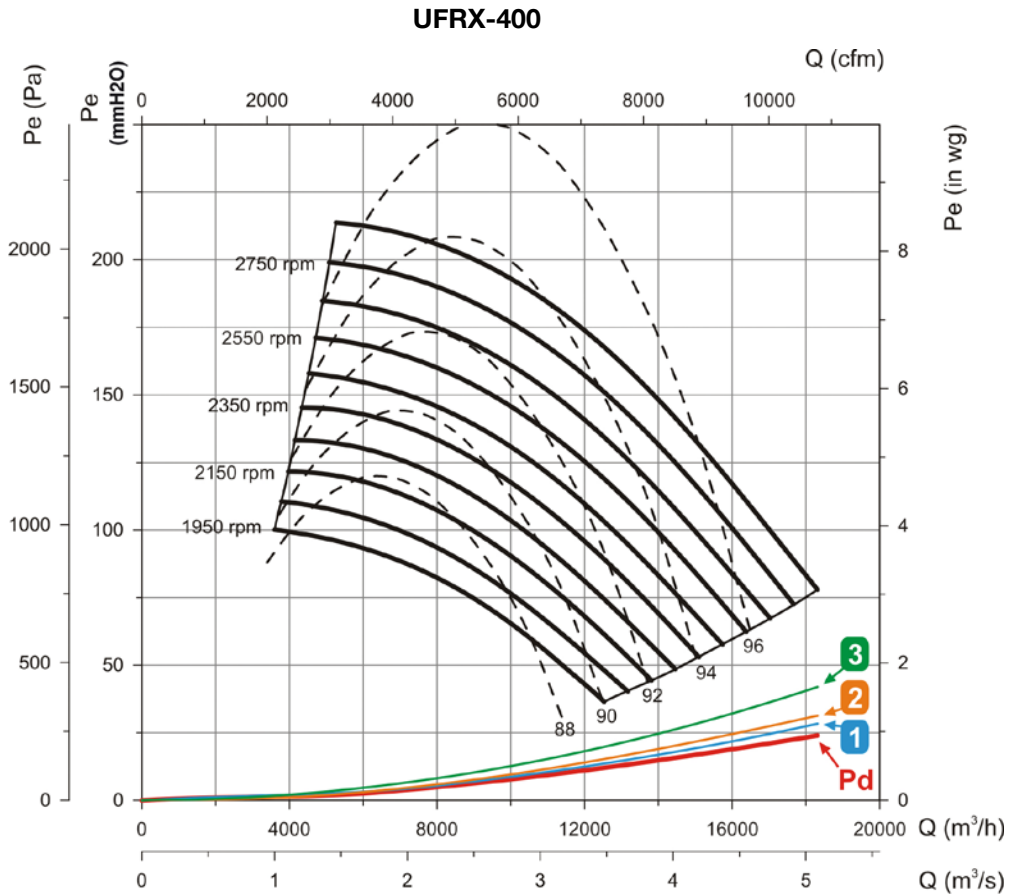

FILTRATION AND DISINFECTION UNITS

Characteristic curves

Useful areas according to filter **1** **F6+F2** **F7+3** **G4+F6**
 Static pressure Dynamic pressure Sound power dB(A) - - - - -

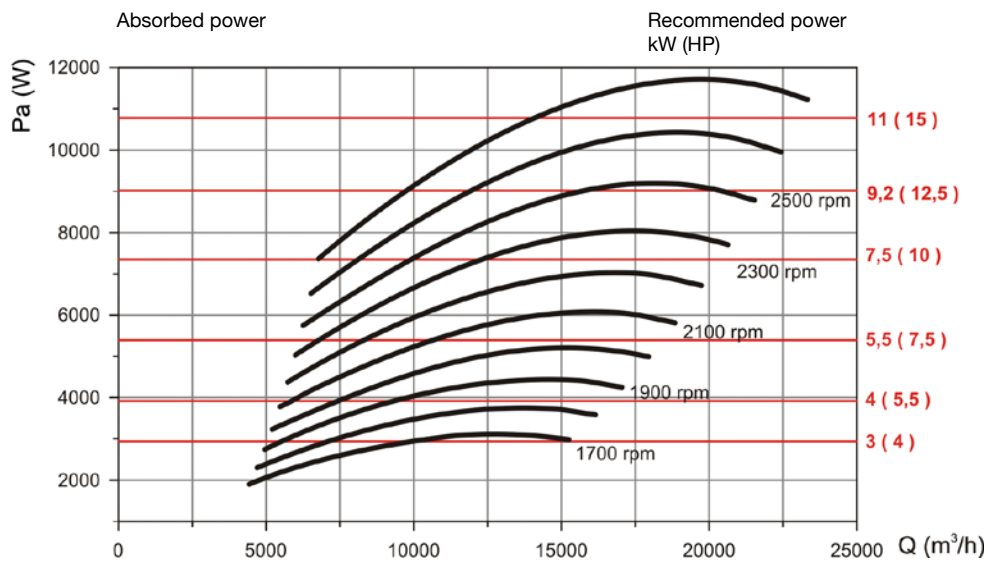
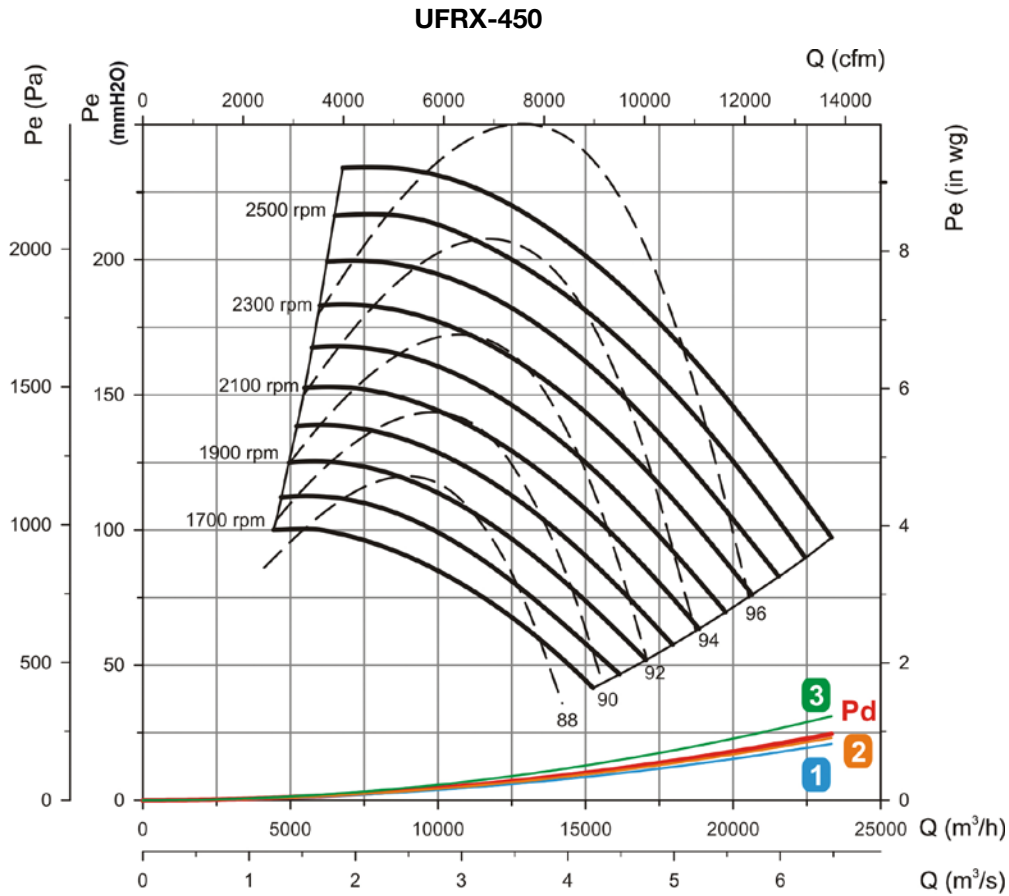

FILTRATION AND DISINFECTION UNITS

Characteristic curves

Useful areas according to filter **1** F6+F**2** F7+**3** G4+F6
 Static pressure Dynamic pressure Sound power dB(A)

UFRX-500

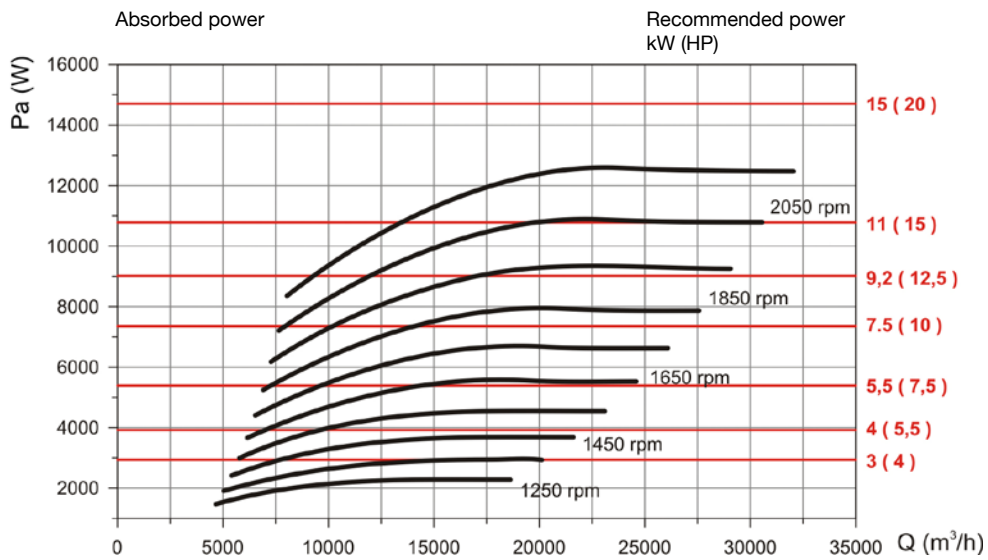
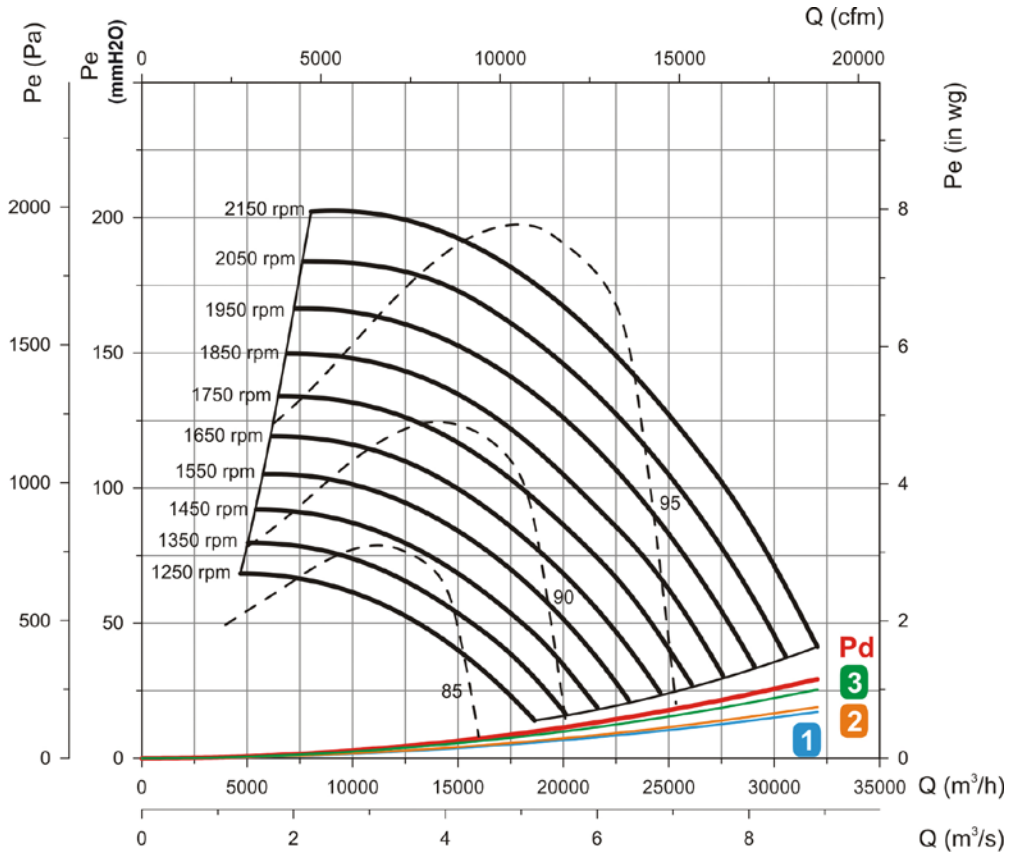

FILTRATION AND DISINFECTION UNITS

Characteristic curves

Useful areas according to filter **1** **F6+F2** **F7+3** **G4+F6**

Static pressure Dynamic pressure Sound power dB(A) - - - - -

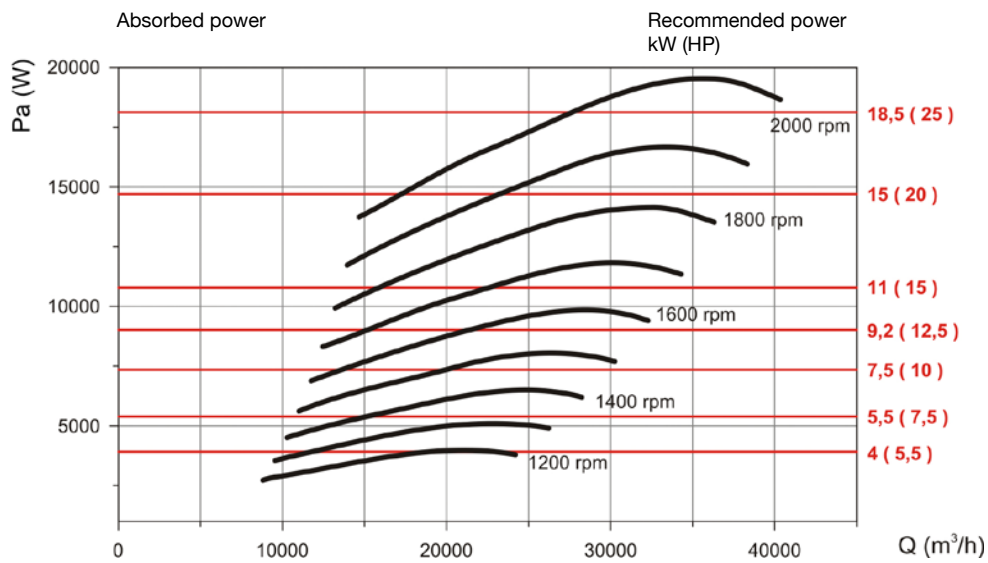
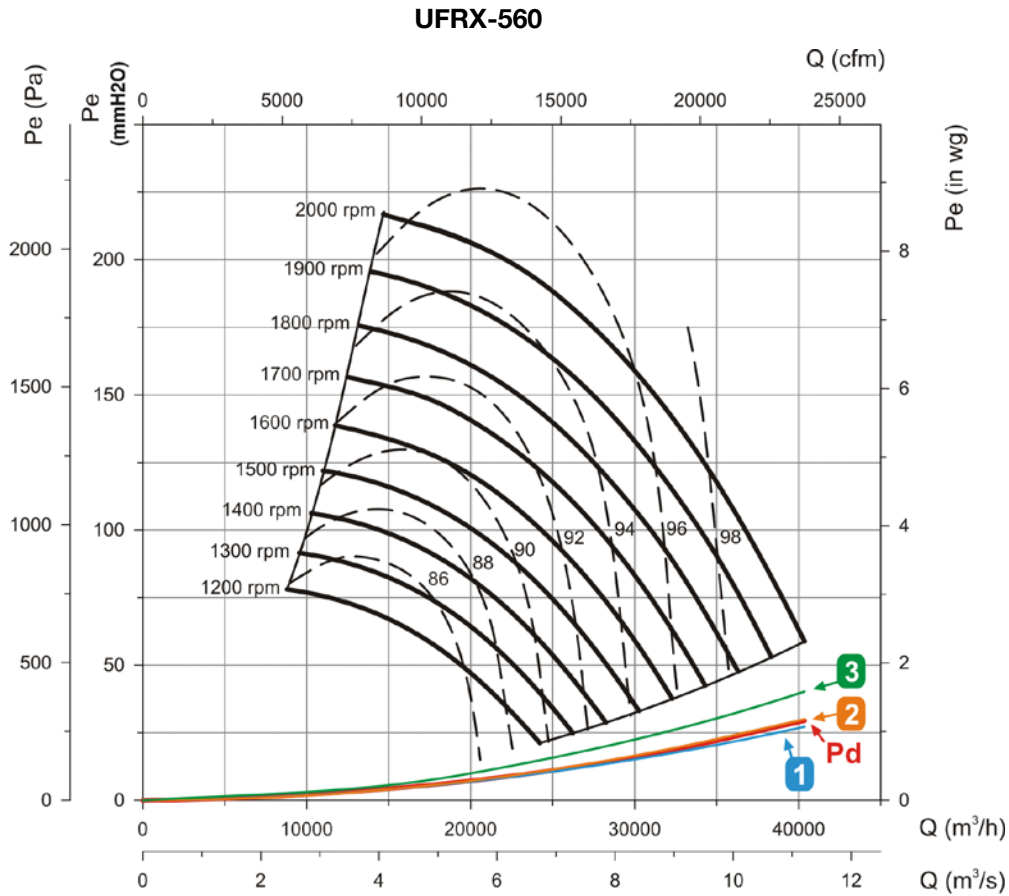

FILTRATION AND DISINFECTION UNITS

Characteristic curves

Useful areas according to filter **1** F6+F**2** F7+**3** G4+F6
 Static pressure _____ Dynamic pressure _____ Sound power dB(A) _____

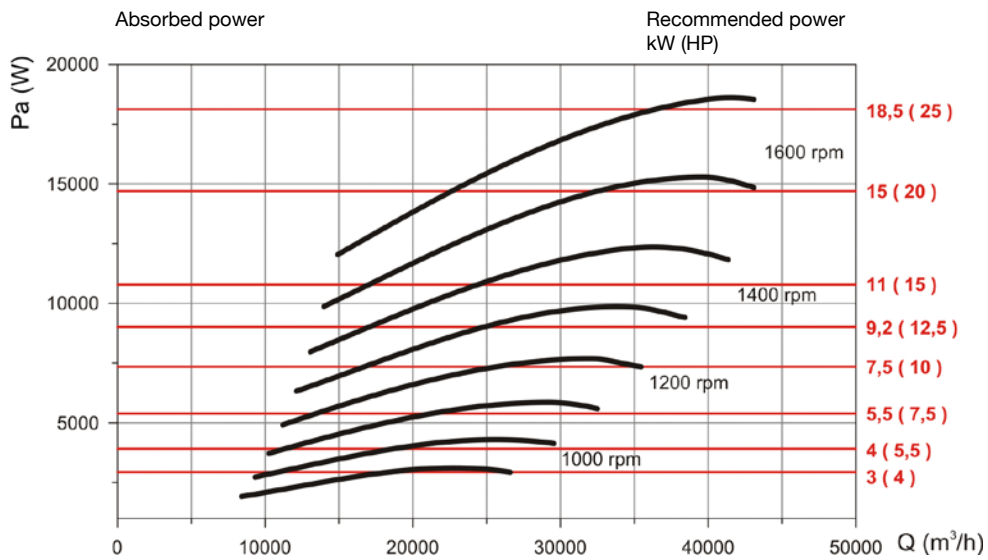
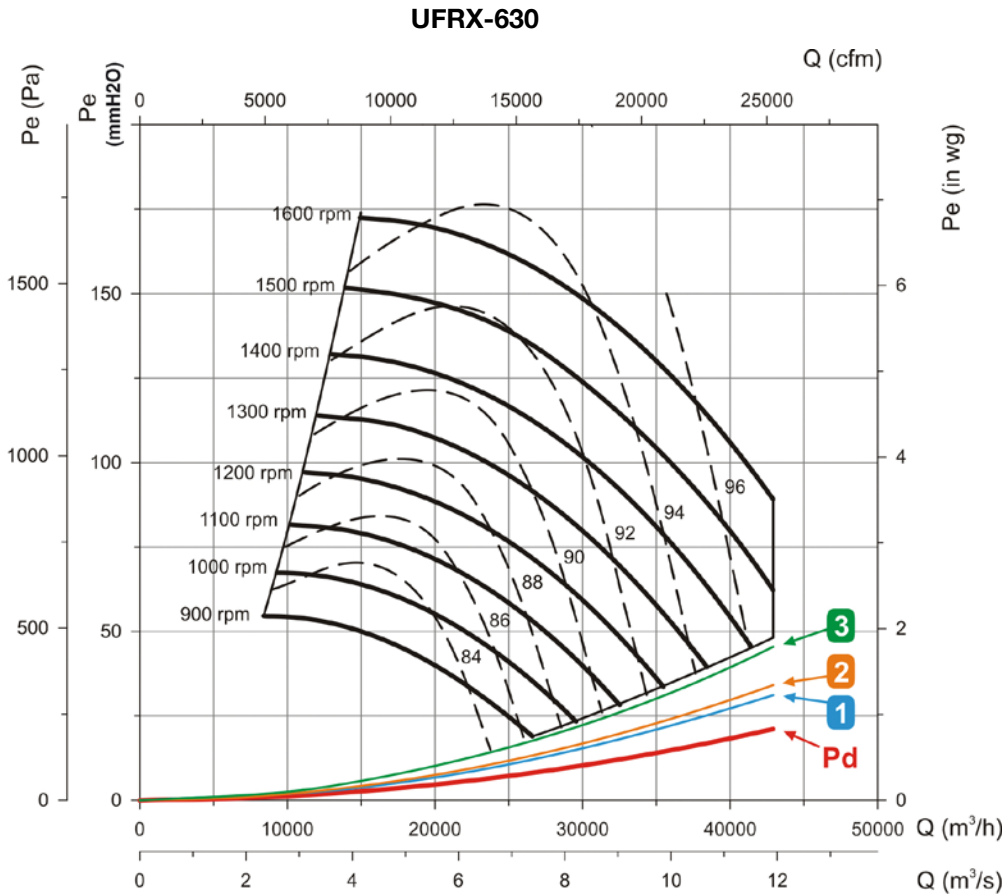

CJFILTER/REC

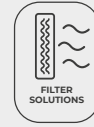

Filter boxes for circular and rectangular ducts, equipped with different types of filter depending on the model



Main characteristics:

- Side maintenance access panel.
- Easy to install.
- Filters can easily and quickly be replaced using guides.
- 5 mm thick acoustic insulation.
- Low profile models for false ceiling installation.
- Compact F7 and F9 efficiency filters for 98 mm rail mounting.
- 292 mm deep polyhedral E10, H13 and CA (active carbon) efficiency filters for mounting on 25 mm rail.

Order code

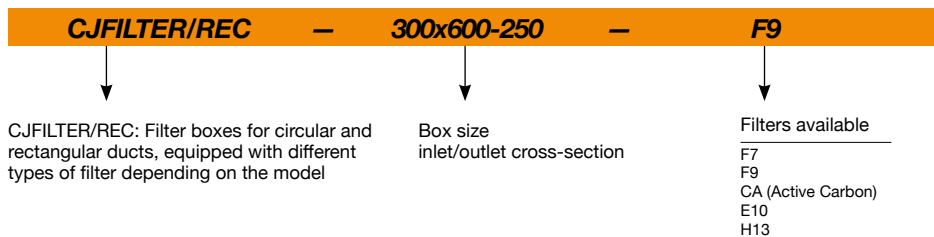

Dimensions mm

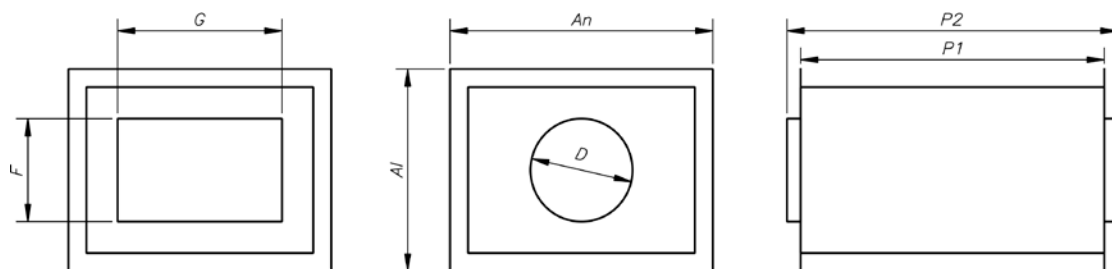

	Al	An	P1	P2	F	G	D
CJFILTER/REC-300x600-150	370	640	450	530	-	-	150
CJFILTER/REC-300x600-160	370	640	450	530	-	-	160
CJFILTER/REC-300x600-200	370	640	450	530	-	-	200
CJFILTER/REC-300x600-250	370	640	450	530	-	-	250
CJFILTER/REC-300x600-250x500	370	640	450	530	250	500	-
CJFILTER/REC-500x700-250x500	570	740	450	530	250	500	-
CJFILTER/REC-500x700-300x700	570	740	450	530	300	700	-
CJFILTER/REC-500x700-315	570	740	450	530	-	-	315
CJFILTER/REC-500x700-355	570	740	450	530	-	-	355
CJFILTER/REC-500x700-400x700	570	740	450	530	400	700	-

	Al	An	P1	P2	F	G	D
CJFILTER/REC-600x1200-450	670	1240	450	530	-	-	450
CJFILTER/REC-600x1200-500x800	670	1240	450	530	500	800	-
CJFILTER/REC-600x600-315	670	640	450	530	-	-	315
CJFILTER/REC-600x600-400	670	640	450	530	-	-	400
CJFILTER/REC-600x900-315	670	940	450	530	-	-	315
CJFILTER/REC-600x900-350x600	670	940	450	530	350	600	-
CJFILTER/REC-600x900-355	670	940	450	530	-	-	355
CJFILTER/REC-600x900-400x700	670	940	450	530	400	700	-
CJFILTER/REC-600x900-450	670	940	450	530	-	-	450
CJFILTER/REC-600x900-500x800	670	940	450	530	500	800	-

Load loss characteristic curves

Q= Flow rate in m³/h, m³/s and cfm Pe= Static pressure in mm H₂O, Pa and inwg

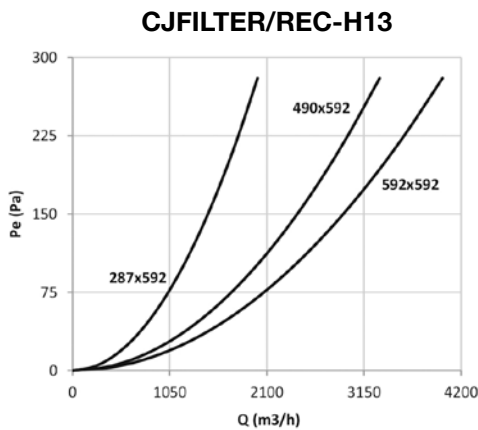
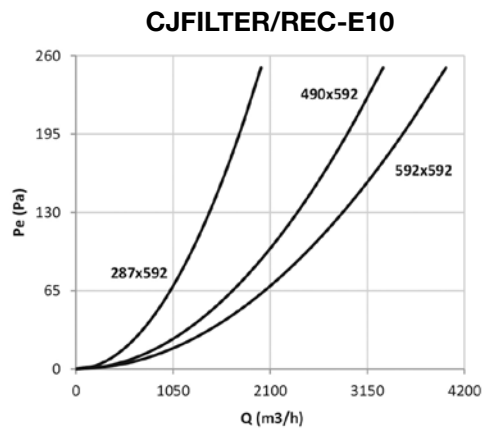
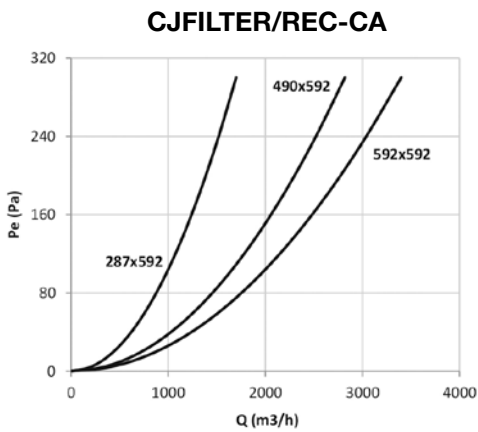
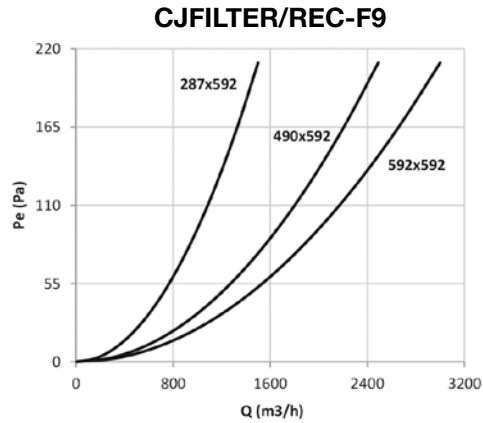
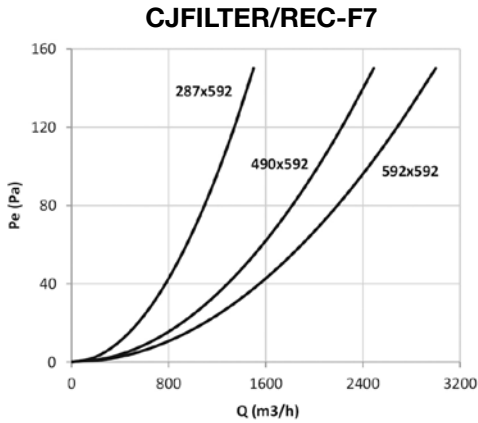

Codes of available filters and filter combinations according to box sizes

BOX SIZE (Height x Width)	N° OF FILTERS ACCORDING TO BOX SIZE FILTER SIZE			FILTER CODE ACCORDING TO SIZE AND EFFICIENCY					
	287x592	490x592	592x592	FILTER SIZE	F7	F9	CA	E10	H13
300x600	1	-	-	287x592	1104804	1104833	1082526	1104852	1104857
500x700	-	1	-	490x592	1104832	1104846	1104849	1104855	1104858
600x600	-	-	1	592x592	1082426	1104847	1082525	1104856	1104859
900x600	1	-	1						
1200x600	-	-	2						

MF

Filter units without a fan but with various filter options

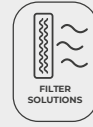

Filter units without a fan but offering various filter options, designed to clean air by trapping airborne particulate matter present inside buildings.

Characteristics:

- Aluminium profile structure.
- Covers with a high quality, 25 mm thick acoustic casing made of prefinished sheet.
- Side access panel for proper maintenance.
- Modular construction for use in combination with different air treatment units.

- Compatible with most existing aluminium profile type models: CJK/EC, CJK/FILTER/EC, UPC/EC, CJBX/AL, CJBD/AL, CJDXR/AL, UFRX/ALS...
- Filtration stages options:
 - G4 + F7.
 - F6 + F8.
 - F7 + F9.
- Easy to remove filters for cleaning and maintenance.

Order code

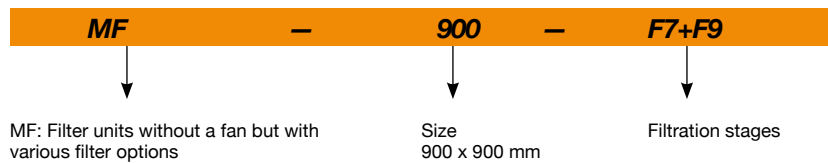

Filter characteristics

	EN 779	EN 1822	ISO 16890		
	<i>Em</i>		ISO ePM ₁	ISO ePM _{2,5}	ISO ePM ₁₀
F6	60-80%	-	-	>50-65%	>60%
F7	80-90%	-	>50-65%	>65-80%	>85%
F8	90-95%	-	>65-80%	>80%	>90%
F9	>95%	-	>80%	>95%	>95%

Technical characteristics

Model	Cross section mm		Approx. weight (Kg)	Maximum flow rate (m ³ /h)	Model	Cross section mm		Approx. weight (Kg)	Maximum flow rate (m ³ /h)
	Height	Width				Height	Width		
MF-490	490	490	16	1813	MF-1000	1000	1000	51	8983
MF-500	500	500	19	1323	MF-1195	1195	1195	73	10372
MF-550	550	550	19	2384	MF-1250	1250	1250	79	10372
MF-605	605	605	21	2970	MF-1450	1450	1450	94	15038
MF-680	680	680	23	3887	MF-1670	1670	1670	105	23338
MF-700	700	700	35	2593					
MF-855	855	855	41	6464					
MF-900	900	900	58	3759					

Installation examples

Set-up next to a ventilation unit

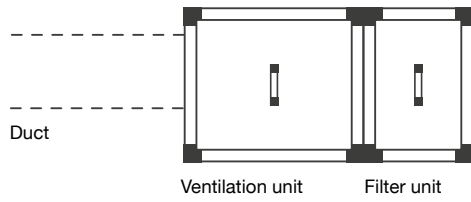

Set-up between ducts

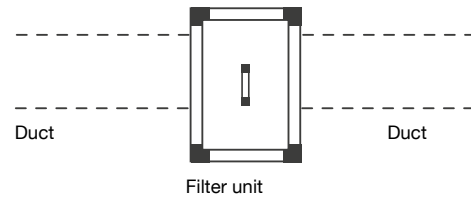

Dimensions mm

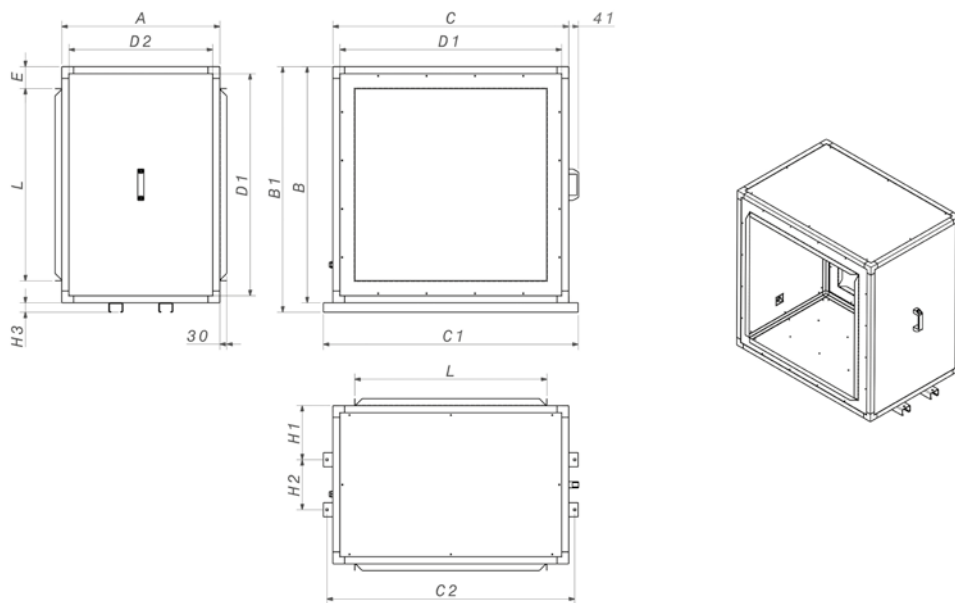

	A	B	B1	C	C1	C2	D1	D2	E	L	H1	H2	H3
MF-490	510	490	-	490	-	-	430	450	83.4	323.2	-	-	-
MF-500	500	500	-	500	-	-	420	420	58.4	383.2	-	-	-
MF-550	510	550	-	550	-	-	490	450	83.4	383.2	-	-	-
MF-605	510	605	-	605	-	-	545	450	106.9	391.2	-	-	-
MF-680	510	680	-	680	-	-	620	450	84.4	511.2	-	-	-
MF-700	700	700	-	700	-	-	620	620	94.4	511.2	-	-	-
MF-855	670	855	895	855	938	908	795	610	84.4	686.2	229	212	40
MF-900	900	900	-	900	-	-	820	820	106.9	686.2	-	-	-
MF-1000	670	1000	1040	1000	1080	1050	940	610	92.9	814.2	229	212	40
MF-1195	670	1195	1235	1195	1280	1245	1115	590	131.9	931.2	229	212	40
MF-1250	670	1250	1290	1250	1350	1320	1170	590	168.9	912.2	229	212	40
MF-1450	670	1450	1490	1450	1550	1520	1370	590	169.4	1111.2	229	212	40
MF-1670	670	1670	1710	1670	1770	1740	1590	590	137.75	1394.5	229	212	40

Accessories

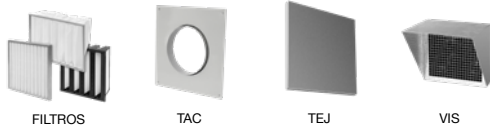

Load loss characteristic curves

Q= Flow rate in m³/h, m³/s and cfm Pe= Static pressure in mm H₂O, Pa and inwg

Filter modules: G4

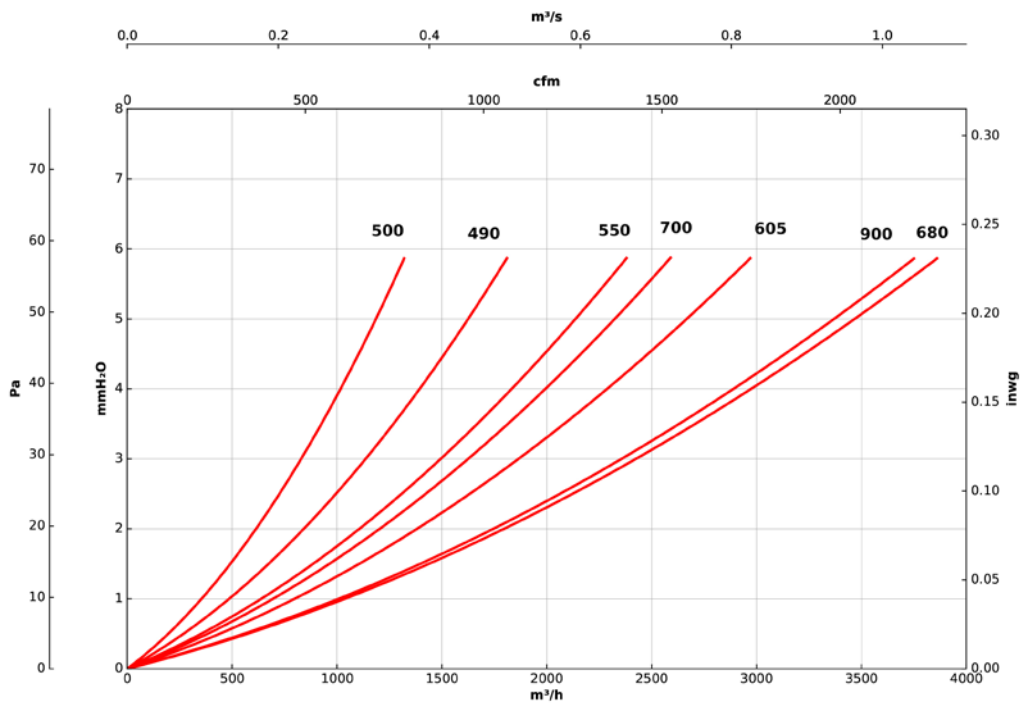

Filter modules: G4

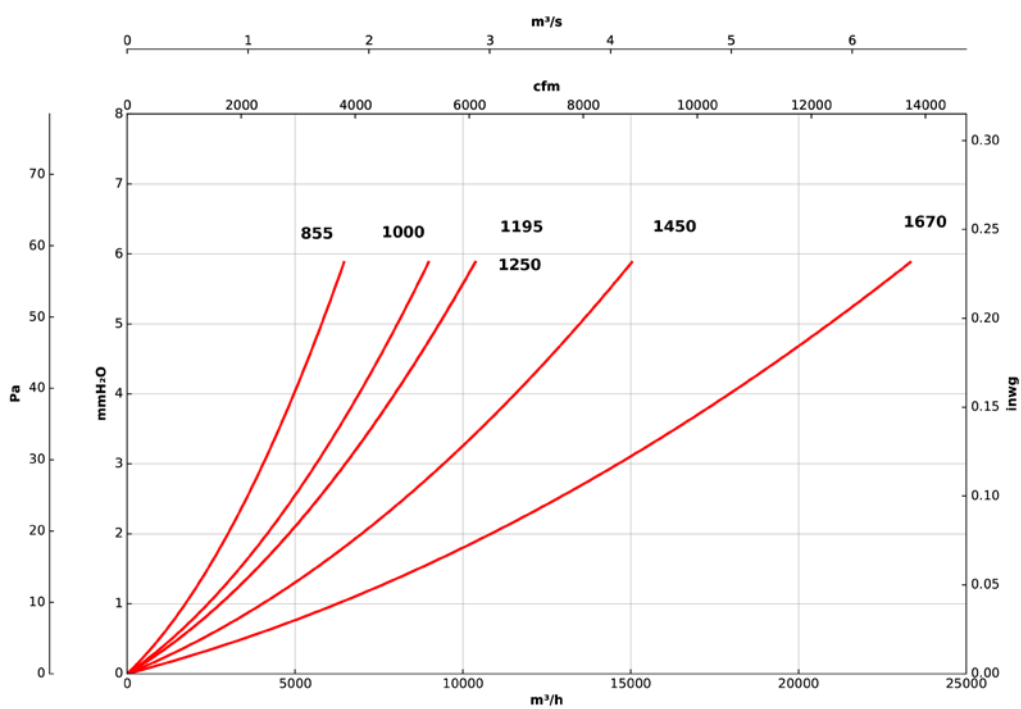

FILTRATION AND DISINFECTION UNITS

Load loss characteristic curves

Q= Flow rate in m³/h, m³/s and cfm Pe= Static pressure in mm H₂O, Pa and inwg

Filter modules: F6

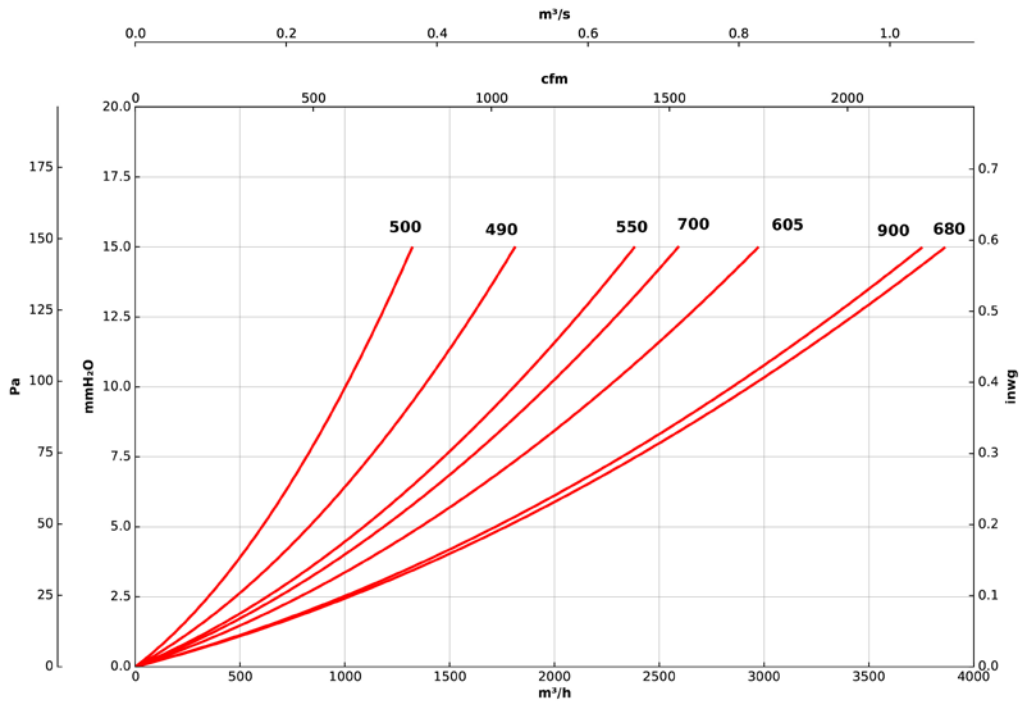

Filter modules: F6

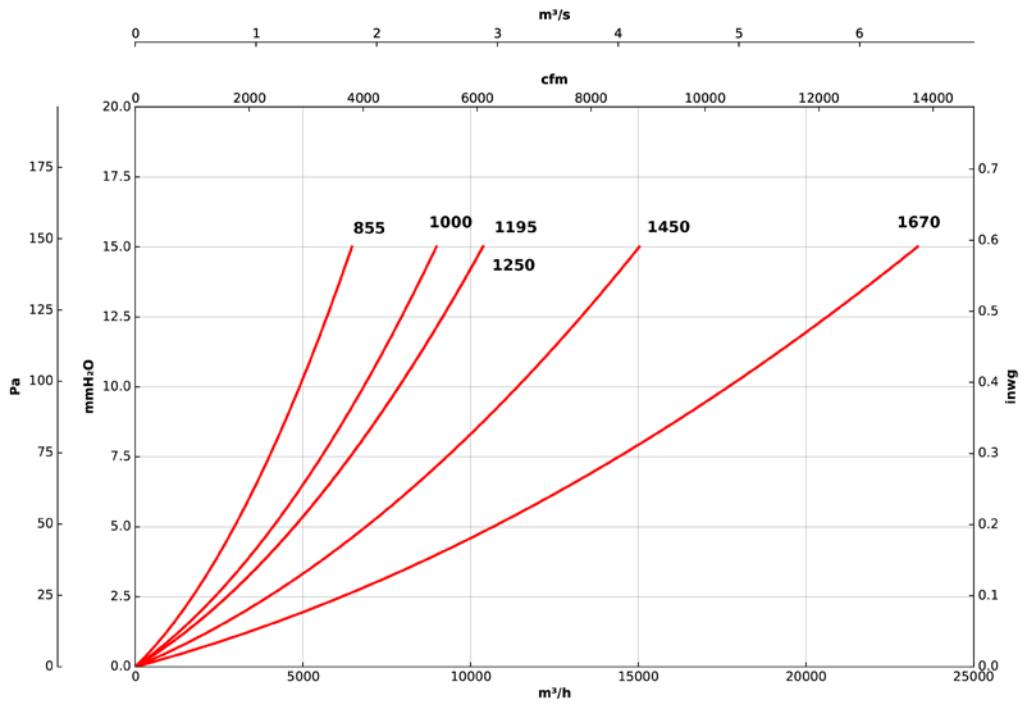

Load loss characteristic curves

Q= Flow rate in m³/h, m³/s and cfm Pe= Static pressure in mm H₂O, Pa and inwg

Filter modules: F7

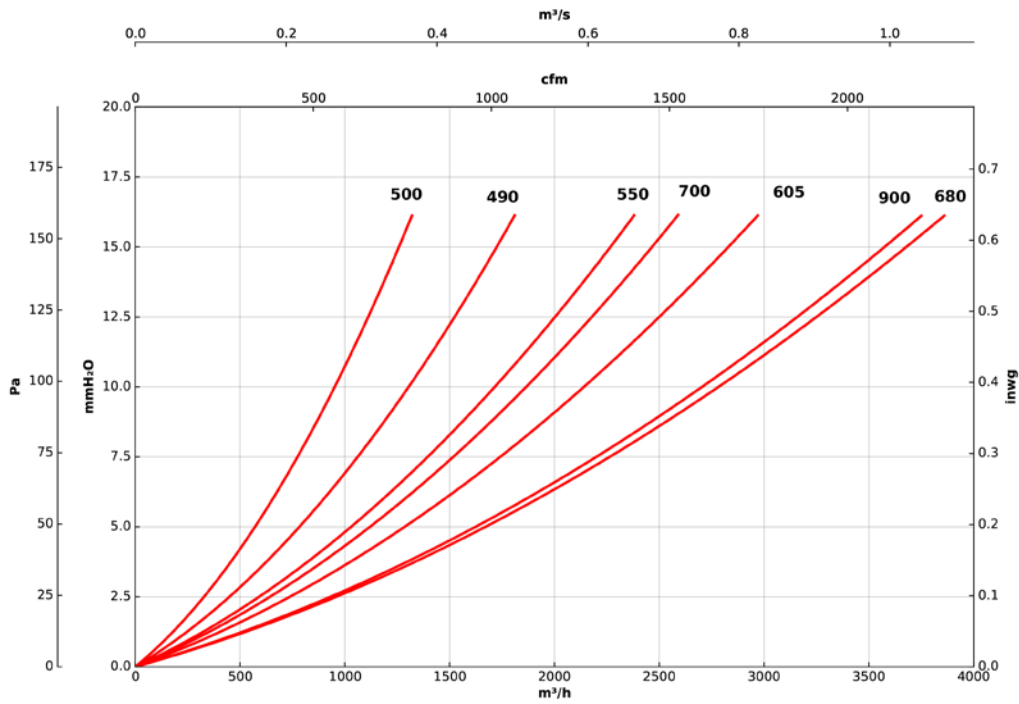

Filter modules: F7

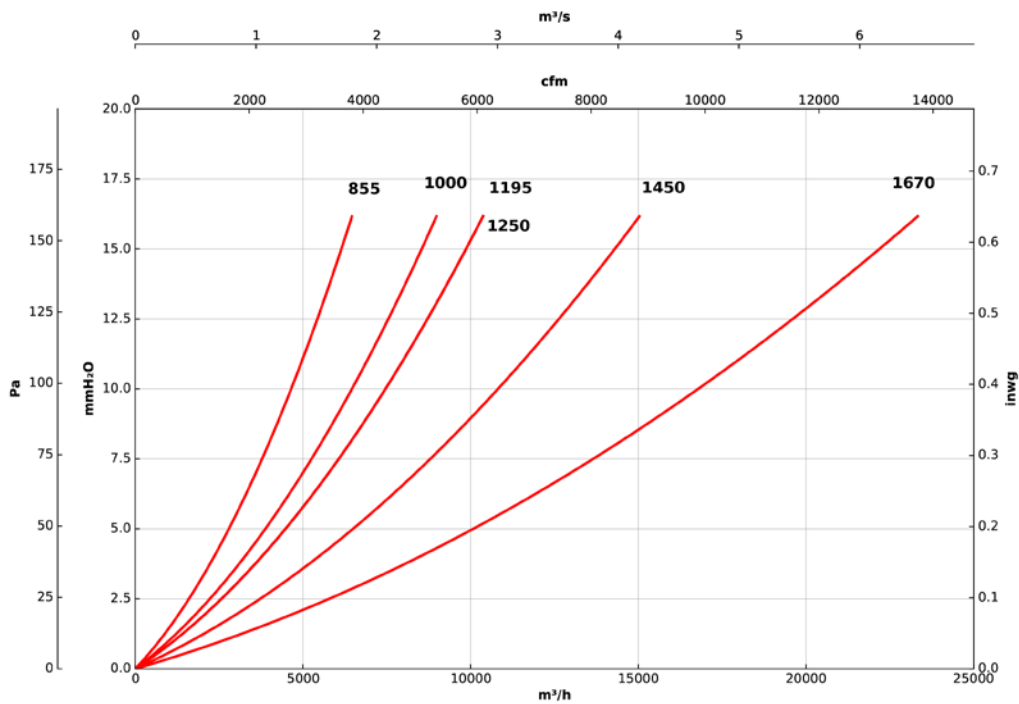

Load loss characteristic curves

Q= Flow rate in m³/h, m³/s and cfm Pe= Static pressure in mm H₂O, Pa and inwg

Filter modules: F8

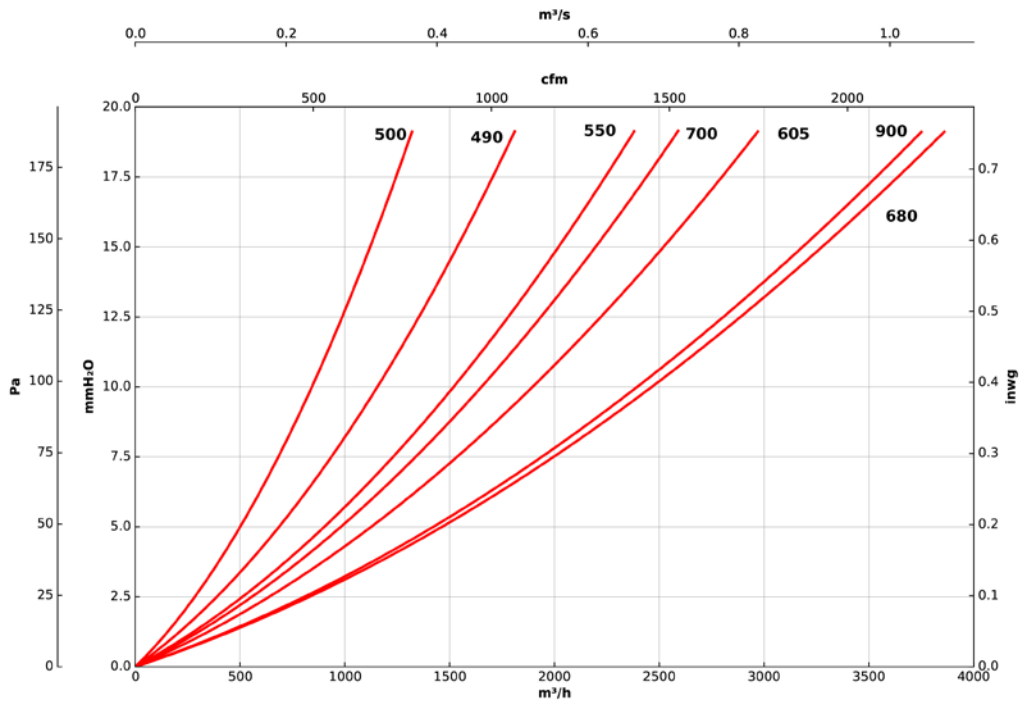

Filter modules: F8

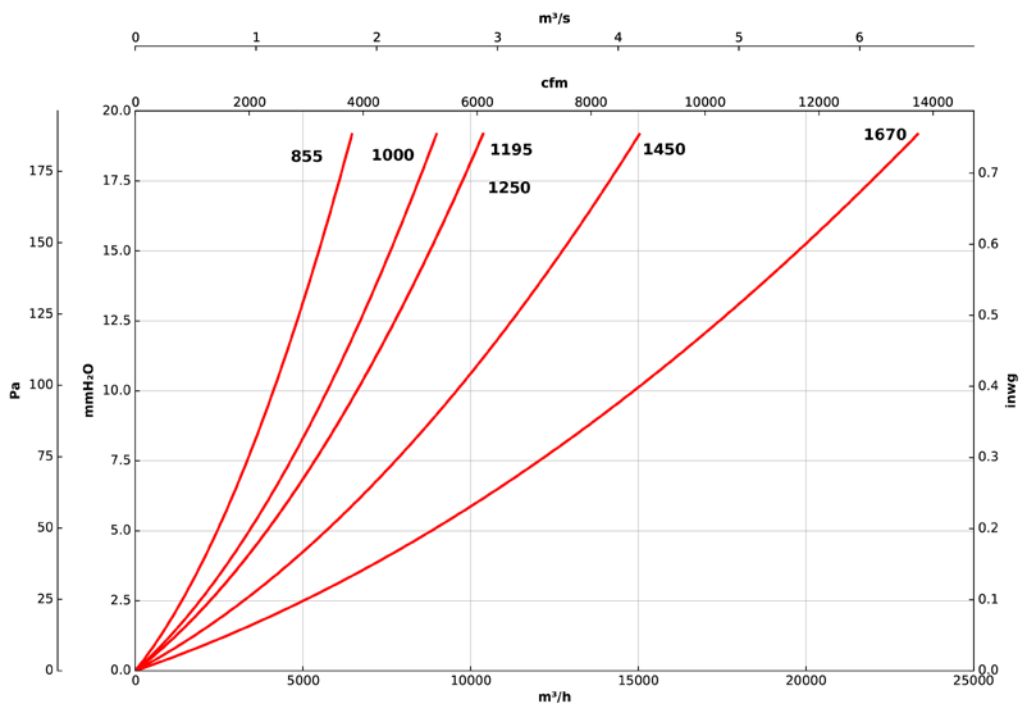

Load loss characteristic curves

Q= Flow rate in m³/h, m³/s and cfm Pe= Static pressure in mm H₂O, Pa and inwg

Filter modules:F9

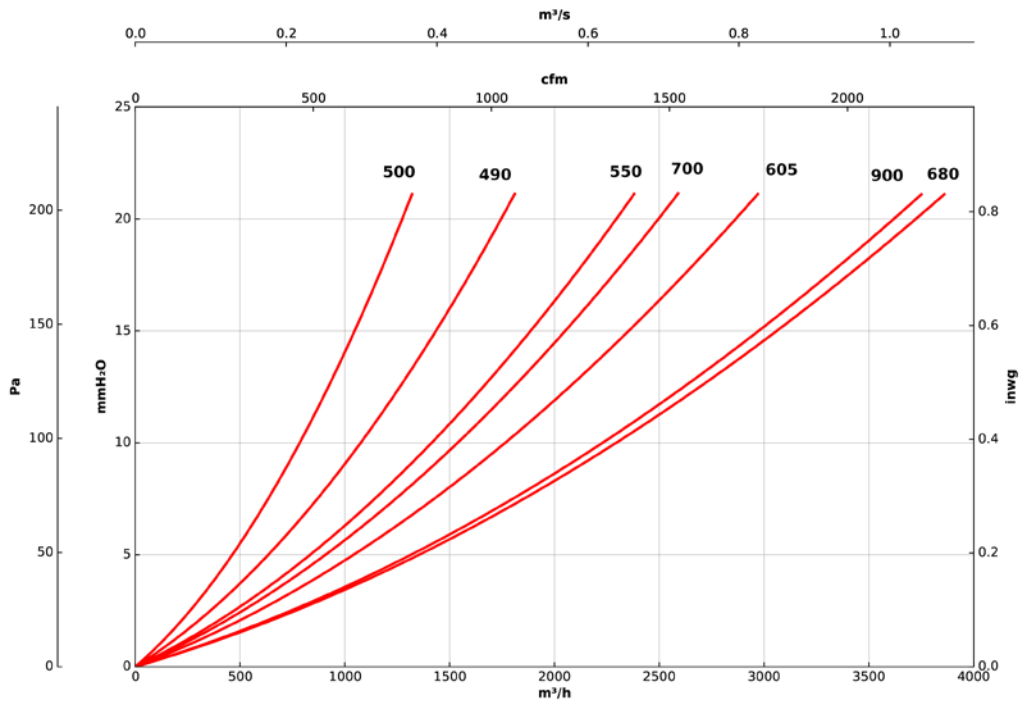

Filter modules: F9

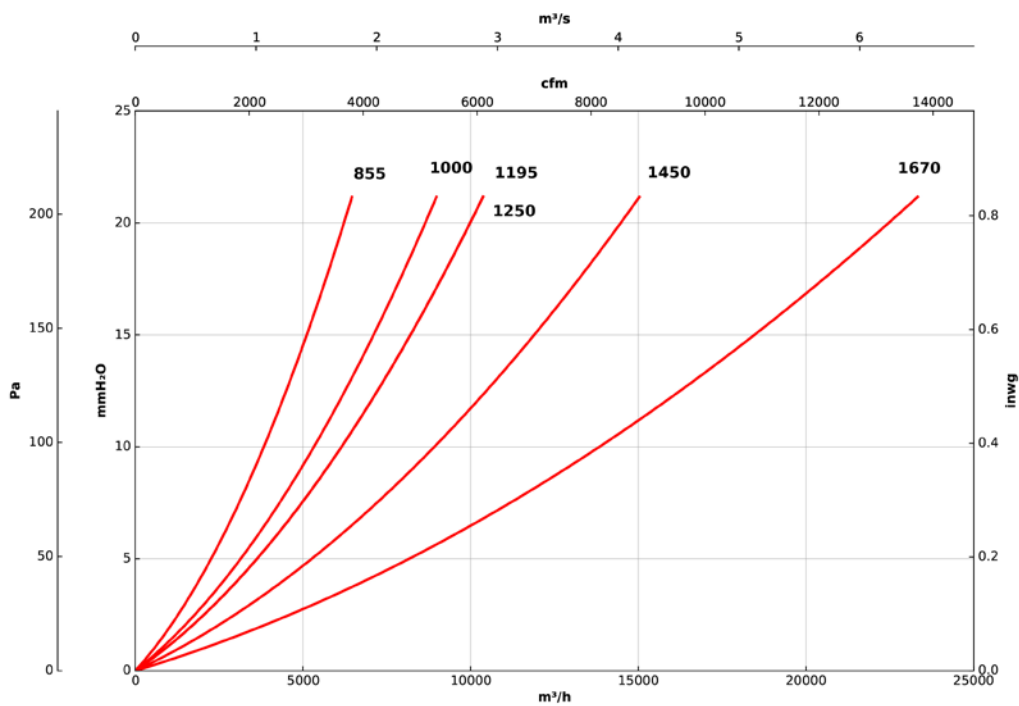

MCA

Filter units without fans, with active carbon filter cartridges



Filter units without a fan but with active carbon filter cartridges, designed for eliminating odours and purifying airborne pollutants.

Characteristics:

- Aluminium profile structure.
- Covers with a high quality, 25 mm thick acoustic casing made of prefinished sheet.
- Side access panel for proper maintenance.

- Modular construction for use in combination with different air treatment units.
- Compatible with most existing aluminium profile type models: CJK/EC, CJK/FILTER/EC, UPC/EC, CJBX/AL, CJBD/AL, CJDXR/AL, UFRX/ALS...
- Filters that are rechargeable, corrosion resistant and easy to remove for cleaning and maintenance.

Order code



Filter characteristics

ACTIVATED CARBON FILTER (CARTRIDGE) - FCCA Material	Height A mm	Diameter B mm	Approx. weight Kg
Galvanised steel	250	145	2.5

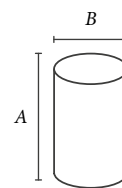

Technical characteristics

Model	Cross section mm		Approx. weight (Kg)	Maximum flow rate (m ³ /h)	Model	Cross section mm		Approx. weight (Kg)	Maximum flow rate (m ³ /h)
	Height	Width				Height	Width		
MCA-490	490	490	20	1250	MCA-1000	1000	1000	66	5000
MCA-500	500	500	23	1250	MCA-1195	1195	1195	92	8750
MCA-550	550	550	22	1250	MCA-1250	1250	1250	99	10000
MCA-605	605	605	25	1250	MCA-1450	1450	1450	127	13750
MCA-680	680	680	31	2500	MCA-1670	1670	1670	154	20000
MCA-700	700	700	44	2500					
MCA-855	855	855	52	3750					
MCA-900	900	900	71	3750					

Installation examples

Set-up next to a ventilation unit

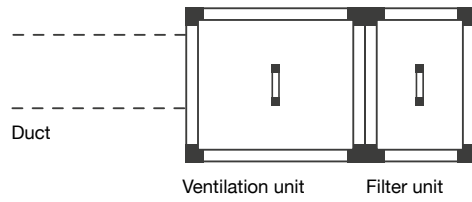

Set-up between ducts

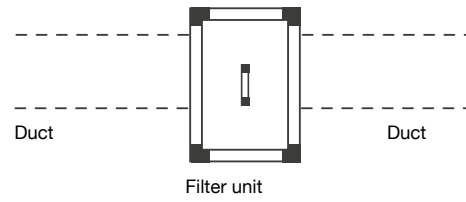

Dimensions mm

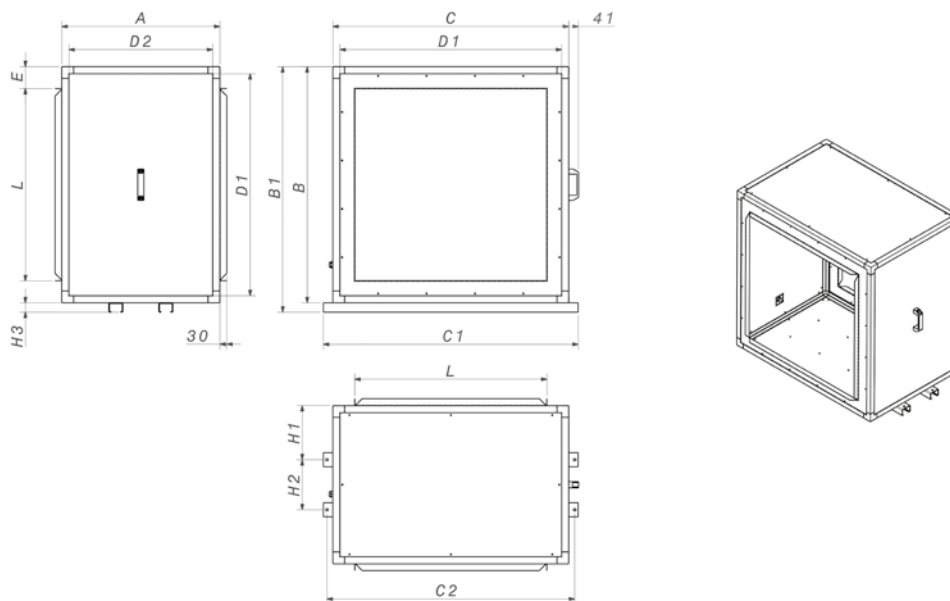

	A	B	B1	C	C1	C2	D1	D2	E	L	H1	H2	H3
MCA-490	510	490	-	490	-	-	430	450	83.4	323.2	-	-	-
MCA-500	500	500	-	500	-	-	420	420	58.4	383.2	-	-	-
MCA-550	510	550	-	550	-	-	490	450	83.4	383.2	-	-	-
MCA-605	510	605	-	605	-	-	545	450	106.9	391.2	-	-	-
MCA-680	510	680	-	680	-	-	620	450	84.4	511.2	-	-	-
MCA-700	700	700	-	700	-	-	620	620	94.4	511.2	-	-	-
MCA-855	670	855	895	855	938	908	795	610	84.4	686.2	229	212	40
MCA-900	900	900	-	900	-	-	820	820	106.9	686.2	-	-	-
MCA-1000	670	1000	1040	1000	1080	1050	940	610	92.9	814.2	229	212	40
MCA-1195	670	1195	1235	1195	1280	1245	1115	590	131.9	931.2	229	212	40
MCA-1250	670	1250	1290	1250	1350	1320	1170	590	168.9	912.2	229	212	40
MCA-1450	670	1450	1490	1450	1550	1520	1370	590	169.4	1111.2	229	212	40
MCA-1670	670	1670	1710	1670	1770	1740	1590	590	137.75	1394.5	229	212	40

Accessories

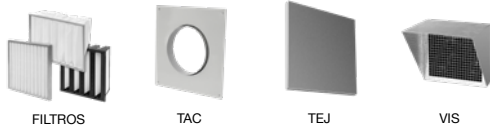

Load loss characteristic curves

Q= Flow rate in m³/h, m³/s and cfm Pe= Static pressure in mm H₂O, Pa and inwg

Filter modules: CA

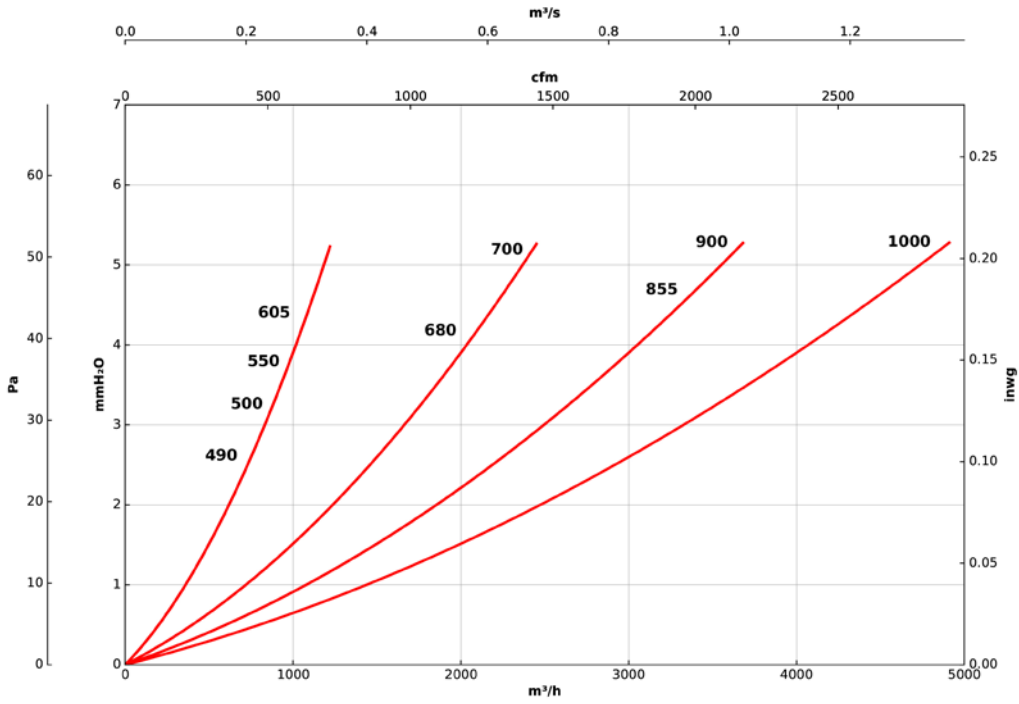

Filter modules: CA

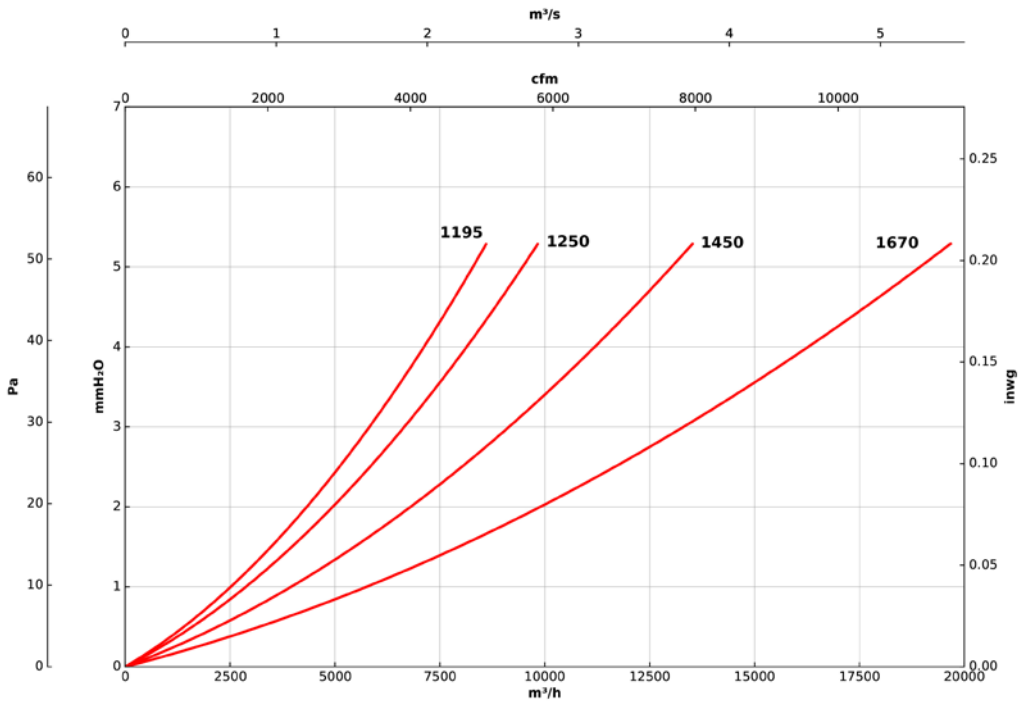

GERMICIDAL CHAMBERS

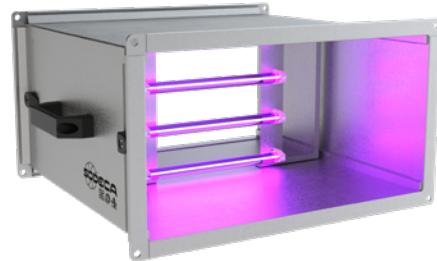

CG/FILTER-UVc

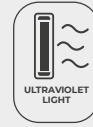

Air purifying units for circular ducts, with 25 mm acoustic surround for noise reduction, without fan



Characteristics:

- 40 mm aluminium profile structure.
- Covers with a high quality, 25 mm thick acoustic casing made of prefinished sheet.
- Standardised inlet and outlet flanges allowing for easy installation in ducts.
- Filtration stages, depending on model:
 - F7 + F9.
 - F7 + HEPA H14.
- Active carbon filter for odour removal.
- Germicidal chamber with UVc ultraviolet lamps (256 nm), depending on model.
- Inspection cover for filter maintenance and replacement.

Finish:

- Aluminium profile and prefinished sheet steel structure with 25 mm thick thermal and acoustic insulation panels.

On request:

- Dirty filter monitoring and alarm.

Order code

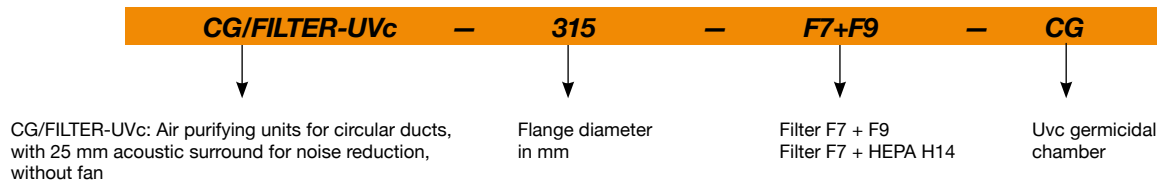

Technical characteristics

Model	Maximum flow rate (m ³ /h)		Approx. weight (Kg)
	Filters (F7+F9)	Filters (F7+H14)	
CG/FILTER/UVc-315	470	415	30
CG/FILTER/UVc-355	700	550	30
CG/FILTER/UVc-450	1800	1400	62
CG/FILTER/UVc-500	2350	2050	105

Filter characteristics

Filters	EN 779 <i>Em</i>	EN 1822	ISO 16890			
			ISO ePM ₁	ISO ePM _{2,5}	ISO ePM ₁₀	ISO COARSE
F7	90%	-	>50%	>65-95%	>85%	-
F9	95%	-	>80%	>95%	>95%	-
HEPA H14	-	>99.995%	-	-	-	-

Technical characteristics of the UVC germicidal chamber

According to the model, these purification units can integrate a germicidal chamber, built with UVC ultraviolet lamps in a 256 nm spectrum, a wave width indicated to inactivate a wide variety of microorganisms by absorbing short wavelength energy through DNA and RNA.

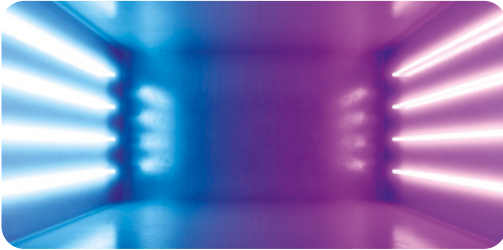

Model	Number of lamps	Total electrical power(W)	Total Uvc radiation power (W)	Radiation dose (mJ/cm ²) *
CG/FILTER/UVc-315	6	54	16.8	7.3
CG/FILTER/UVc-355	6	54	16.8	5.5
CG/FILTER/UVc-450	4	102	28	5.0
CG/FILTER/UVc-500	6	153	42	6.6

*Minimum dose calculated based on flow with filters: F7+HEPA H14

Dimensions mm

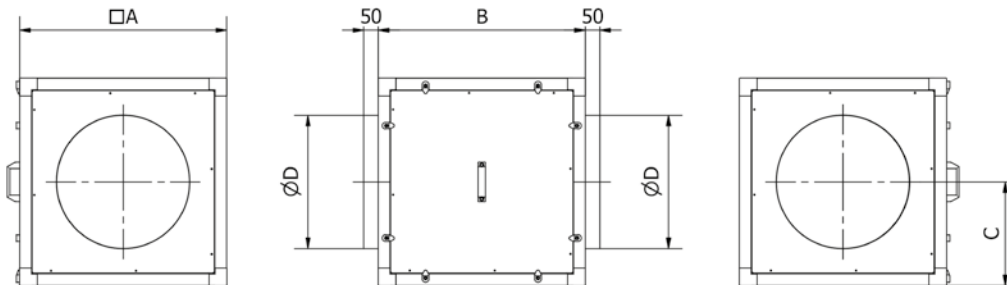

	A	B	C	ØD
CG/FILTER/UVc-315	500	500	250	315
CG/FILTER/UVc-355	500	500	250	355
CG/FILTER/UVc-450	700	700	350	450
CG/FILTER/UVc-500	900	900	450	500

Accessories



Characteristic curves

Q= Flow rate in m³/h, m³/s and cfm

Pe= Static pressure in mm H₂O, Pa and inwg

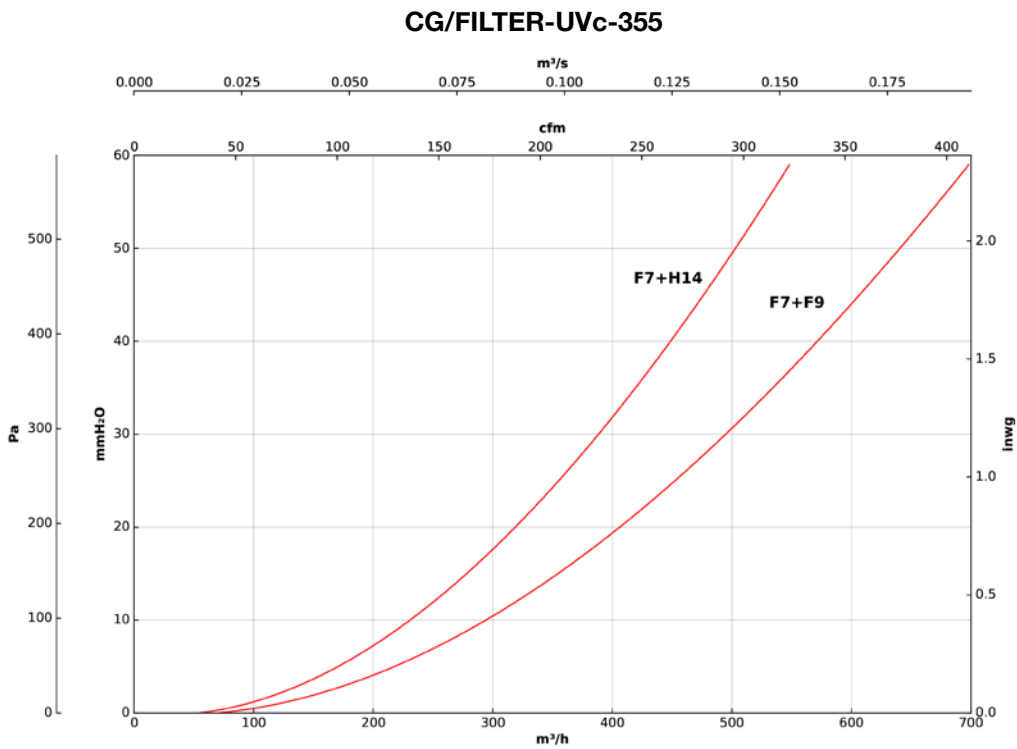
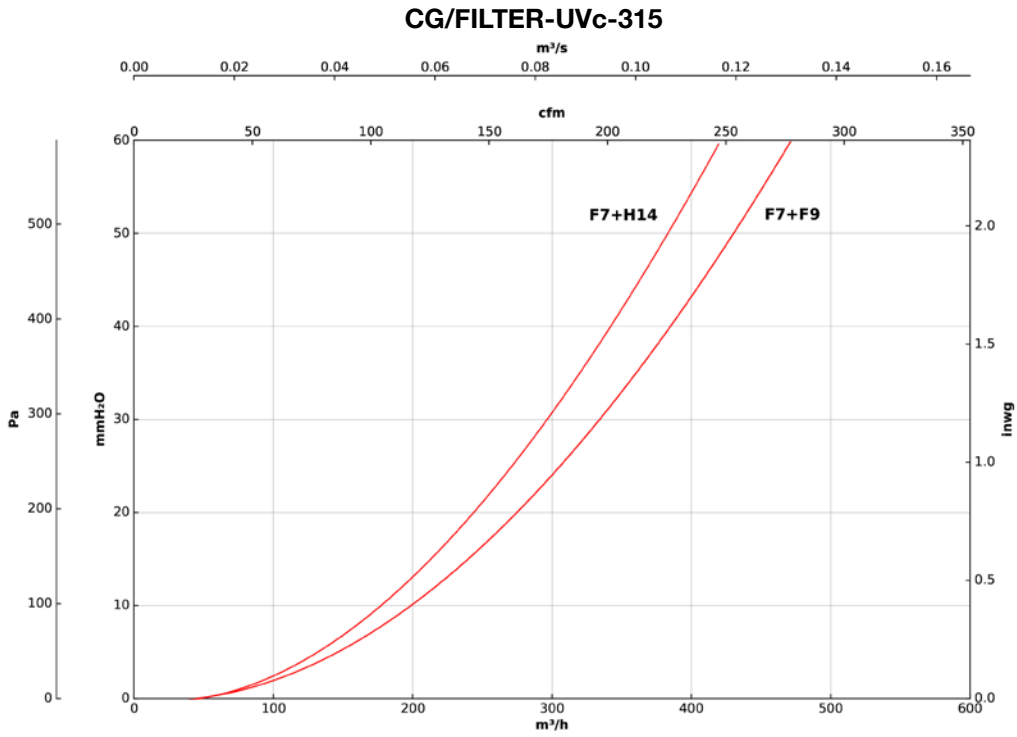

GERMICIDAL CHAMBERS

Characteristic curves

Q= Flow rate in m³/h, m³/s and cfm

Pe= Static pressure in mm H₂O, Pa and inwg

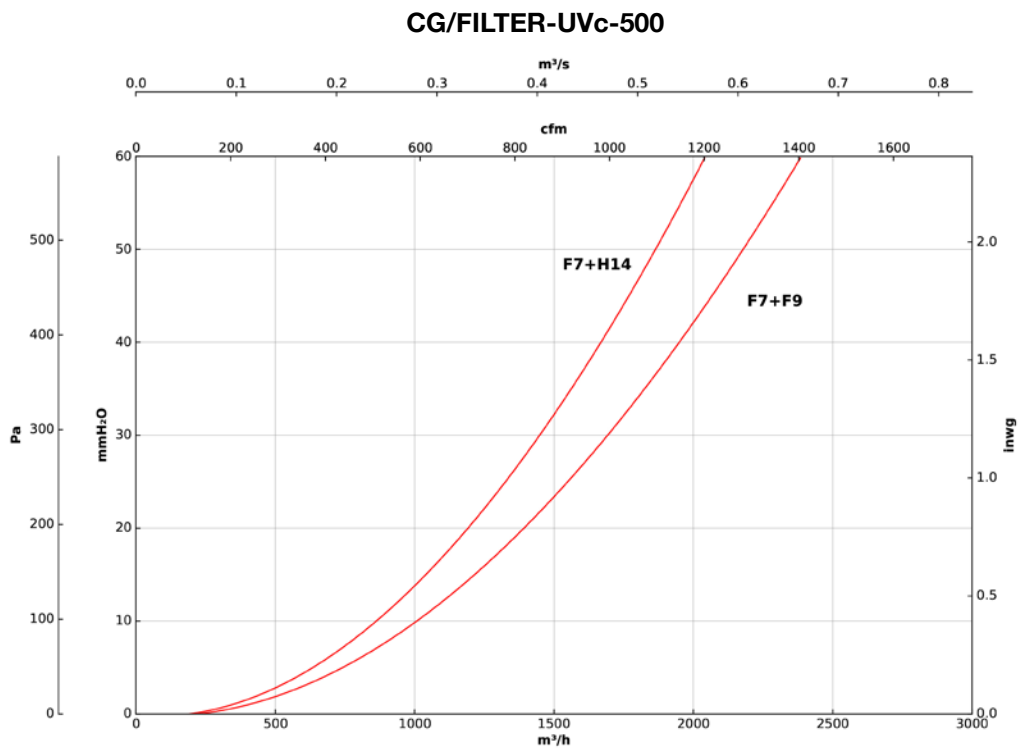
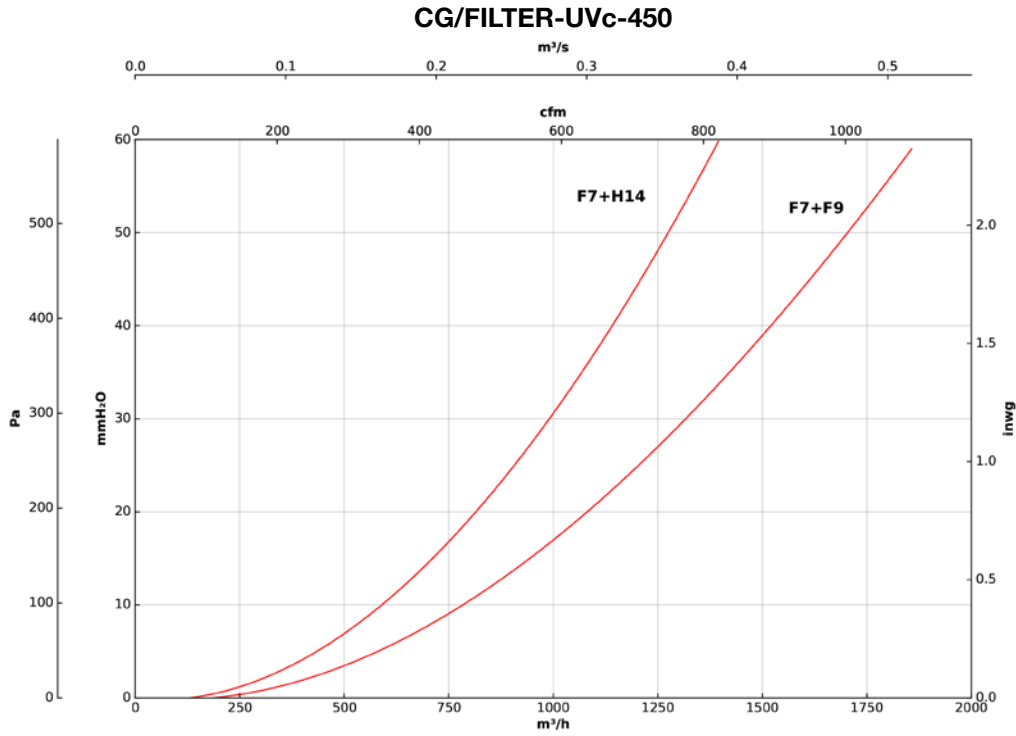

CGR-UVc



UVc germicidal chamber without fan for use in rectangular ducts. Ideal for installation in existing air conditioning and ventilation systems

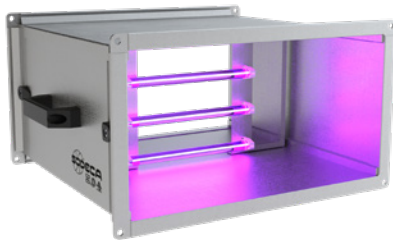

Germicidal chamber without fan for rectangular ducts, equipped with UVc ultraviolet lamps and optionally with filtration stages. Ideal for installation in existing ventilation and air conditioning systems.

Characteristics:

- Germicidal chamber with UVc ultraviolet lamps (256 nm).
- Maintenance access panel.
- Easy to install.
- Low profile models for false ceiling installation.
- Filtration stages according to model F7 + F9 o F7 + HEPA H14.
- Filters can easily and quickly be replaced using guides.
- Standard flanges on inlet and outlet sides to facilitate installation in ducts.
- With safety elements for handling and maintenance of ultraviolet lamps according to the UNE-0068: 2020 standard.

Finish:

- Anti-corrosive in galvanized steel sheet.

CG/LP-UVc



UVc germicidal chamber without fan for use in circular ducts. Ideal for installation in existing air conditioning and ventilation systems

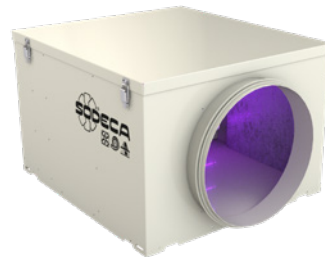

Germicidal chamber without a fan for circular ducts equipped with UVc ultraviolet lamps and with the option of including filtration stages. Ideal for installation in existing air conditioning and ventilation systems.

Characteristics:

- Germicidal chamber with UVc ultraviolet lamps (256 nm).
- Maintenance access panel.
- Easy to install.
- Low profile models for false ceiling installation.
- Filtration stages according to model F7 + F9 o F7 + HEPA H14.
- Filters can easily and quickly be replaced using guides.
- Standard flanges on inlet and outlet sides to facilitate installation in ducts.
- With safety elements for handling and maintenance of ultraviolet lamps according to the UNE-0068: 2020 standard.

Finish:

- Anti-corrosive finish in polyester resin, polymerised at 190 °C, after degreasing with phosphate-free nanotechnology treatment.

Order code

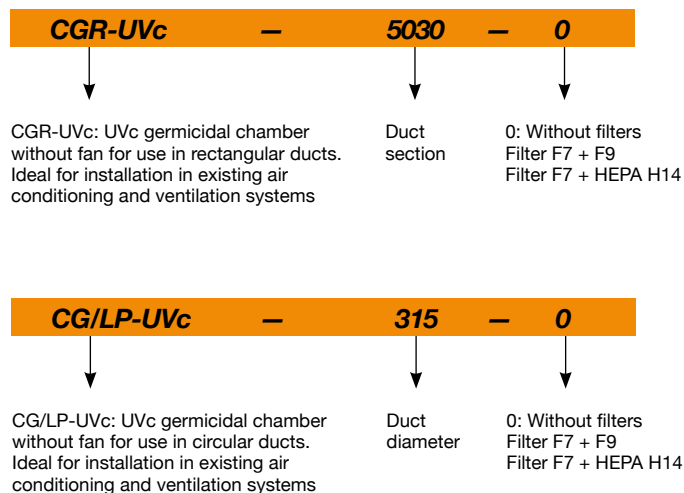

Technical characteristics of the UVc germicidal chamber



According to the model, these purification units can integrate a germicidal chamber, built with UVc ultraviolet lamps in a 256 nm spectrum, a wave width indicated to inactivate a wide variety of microorganisms by absorbing short wavelength energy through DNA and RNA.

Model	Number of lamps	Total electrical power(W)	Total Uvc radiation power (W)
CGR-UVc-4020	4	36	11.2
CGR-UVc-5030	6	54	16.8
CGR-UVc-6030	6	54	16.8
CGR-UVc-6035	4	102	28
CGR-UVc-7040	6	153	42
CGR-UVc-8050	6	153	42

Model	Number of lamps	Total electrical power(W)	Total Uvc radiation power (W)
CG/LP-UVc-200	4	36	11.2
CG/LP-UVc-250	4	36	11.2
CG/LP-UVc-315	4	102	28
CG/LP-UVc-350	4	102	28

Dose calculation

CGR-UVc

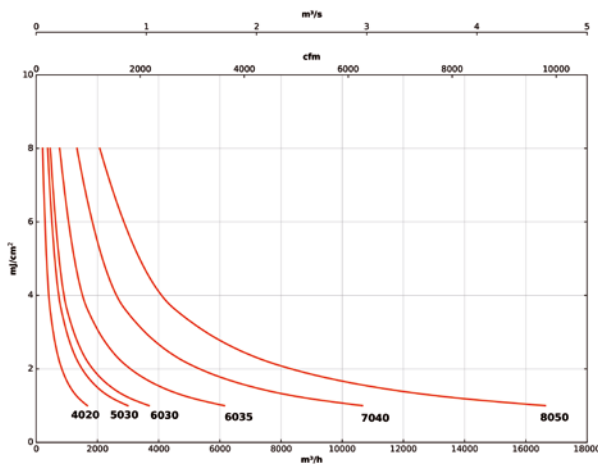

CG/LP-UVc

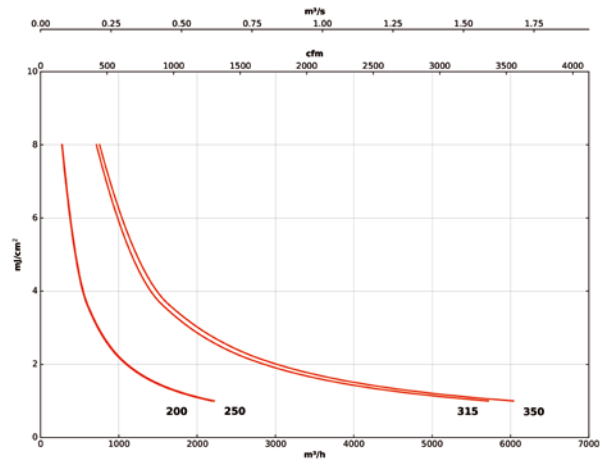

Technical characteristics with filter

Model	Maximum flow rate (m³/h)		Approx. weight (Kg)
	Filters (F7+F9)	Filters (F7+H14)	
CGR-UVc-4020	1385	577	16
CGR-UVc-5030	2863	1193	20
CGR-UVc-6030	3256	1337	28
CGR-UVc-6035	3894	1599	32
CGR-UVc-7040	5301	2177	40
CGR-UVc-8050	7780	3195	50

Model	Maximum flow rate (m³/h)		Approx. weight (Kg)
	Filters (F7+F9)	Filters (F7+H14)	
CG/LP-UVc-200	590	430	6.1
CG/LP-UVc-250	660	560	9.2
CG/LP-UVc-315	1035	850	10.4
CG/LP-UVc-350	1550	1270	12.5

Filter characteristics

Filters	EN 779	EN 1822	ISO 16890		
	Em		ISO ePM ₁	ISO ePM _{2,5}	ISO ePM ₁₀
F7	90%	-	>50%	>65-95%	>85%
F9	95%	-	>80%	>95%	>95%
HEPA H14	-	>99.995%	-	-	-

Dimensions mm

CGR-UVc

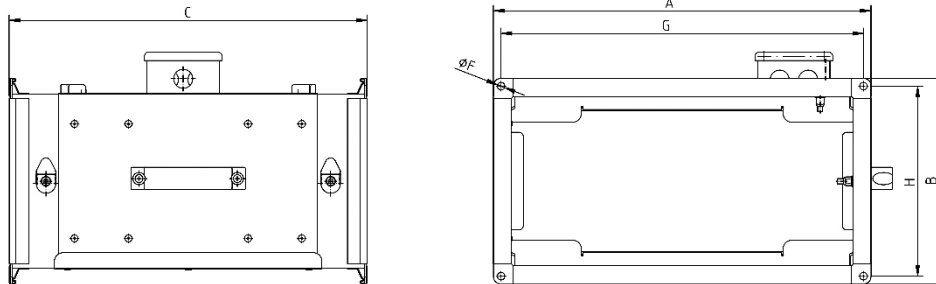

	A	B	C	ØF	G	H
CGR-UVc-4020	440	240	415	Ø9	420	220
CGR-UVc-5030	540	340	495	Ø9	520	320
CGR-UVc -6030	640	340	610	Ø9	620	320
CGR-UVc -6035	640	390	610	Ø9	620	370
CGR-UVc -7040	740	440	705	Ø9	720	420
CGR-UVc -8050	840	540	825	Ø9	820	520

CG/LP-UVc

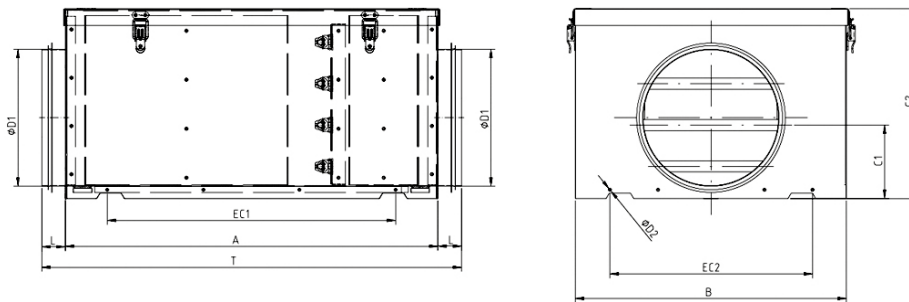

	A	B	C1	C2	ØD1	L	ØD2	EC1	EC2	T
CG/LP-UVc-200	543	395	117	275	198.5	34	4.3	420	360	611.5
CG/LP-UVc-250	550	420	140	294	248.5	48	4.3	420	320	646.5
CG/LP-UVc-315	567	421	175	372	313.5	58	4.3	450	439	683
CG/LP-UVc-350	599	610	200	411	353.5	56	4.3	468	525	711

Accessories



FILTROS

SI-PRESOSTATO

SI-PRESIÓN

SI-MF

SI-CO2 IND

SONDA PRESIÓN
DIFERENCIAL

ACE ACE/400

TEJ

VIS

Load loss characteristic curves

Q= Flow rate in m³/h, m³/s and cfm Pe= Static pressure in mm H₂O, Pa and inwg

CGR-UVc-F7+F9

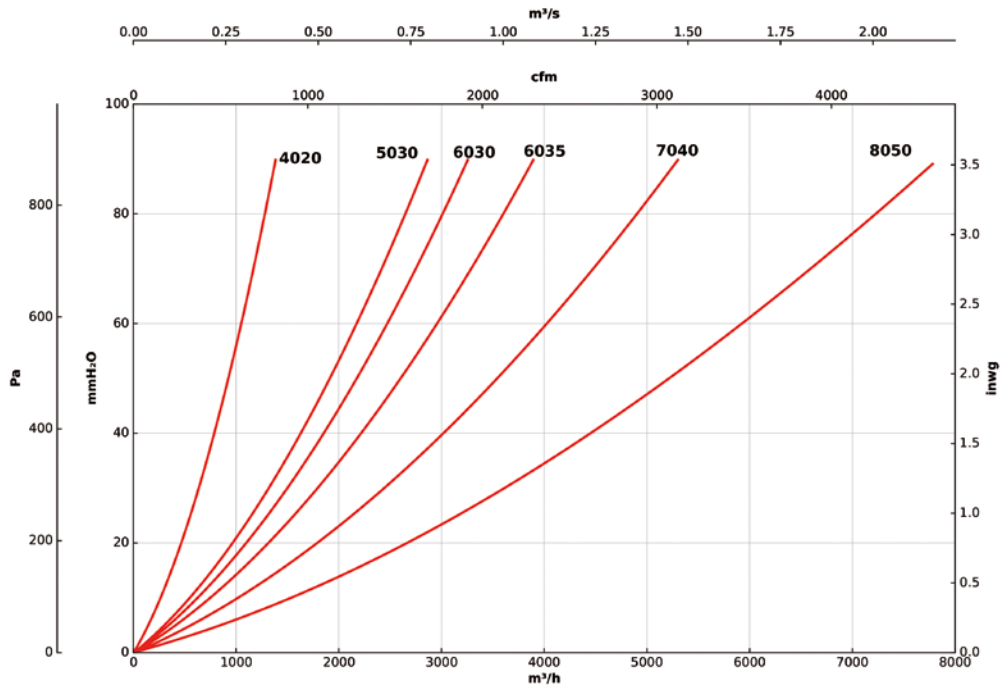

CG/LP-UVc-F7+F9

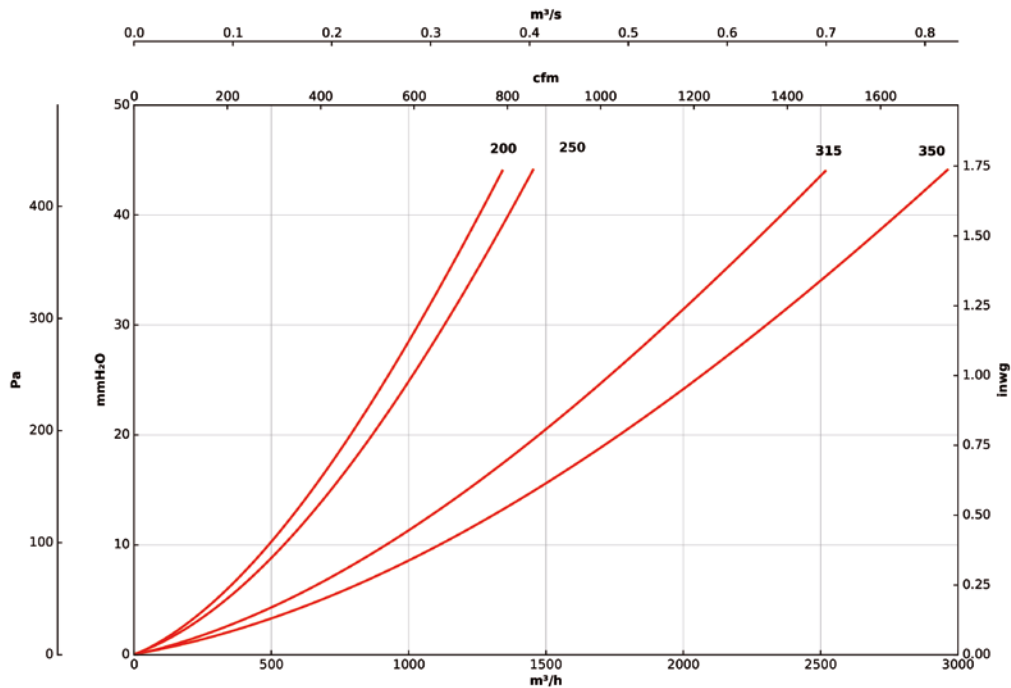

Load loss characteristic curves

Q= Flow rate in m³/h, m³/s and cfm Pe= Static pressure in mm H₂O, Pa and inwg

CGR-UVc-F7+HEPA H14

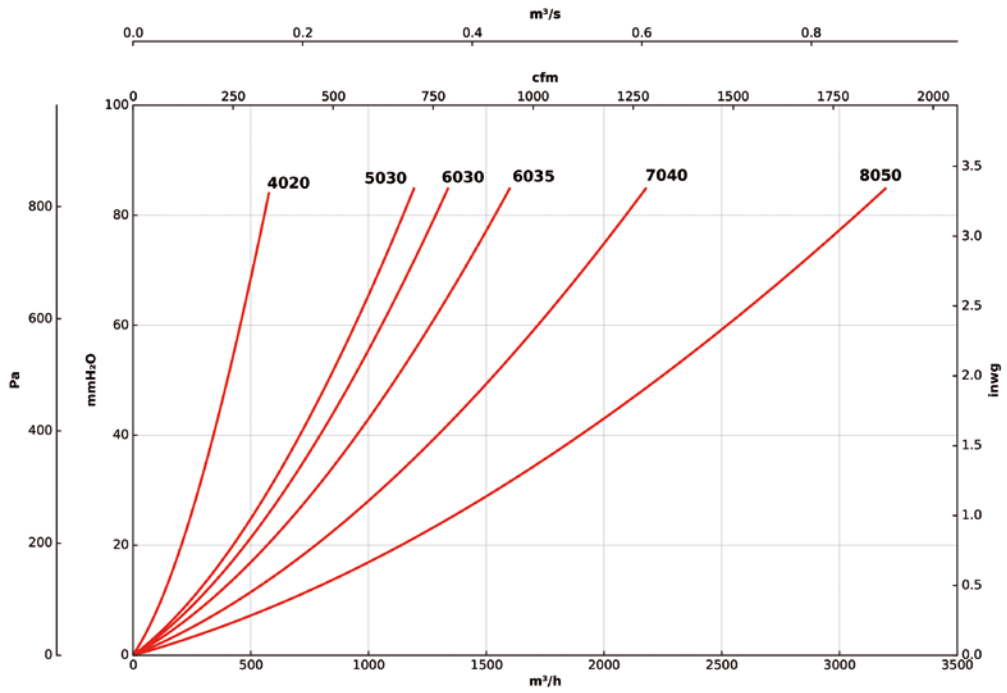

CG/LP-UVc-F7+HEPA H14

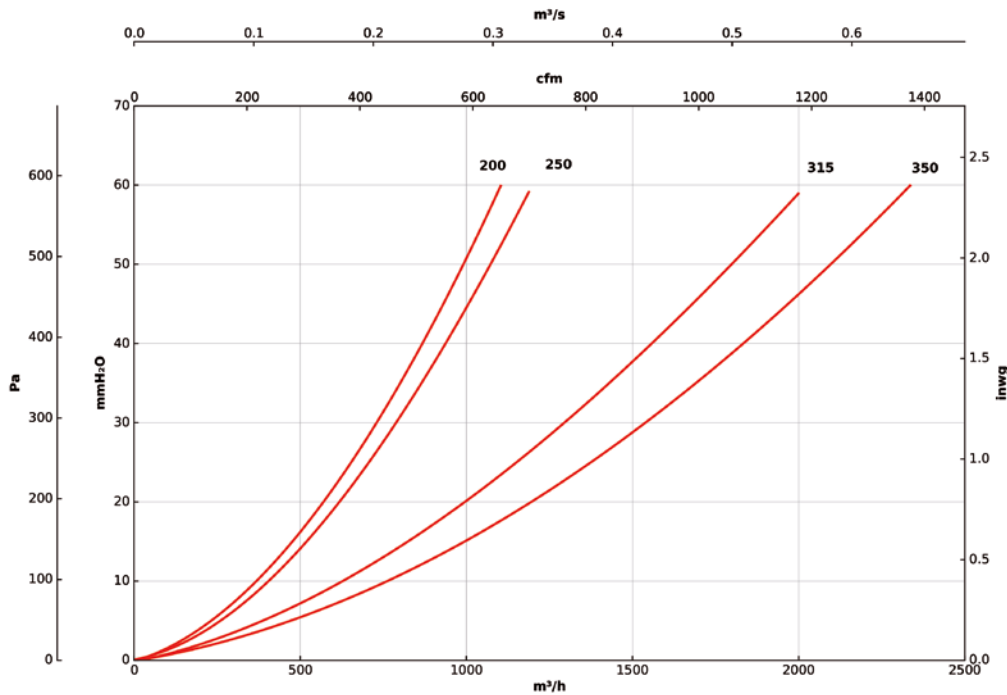

MPCO

Filter units without fans, with photocatalysis technology

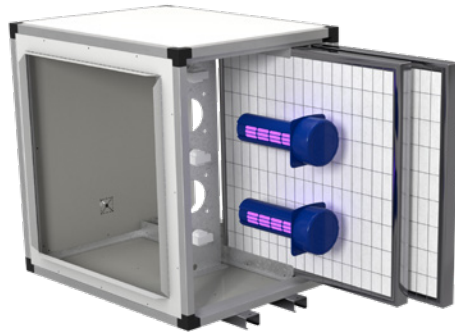
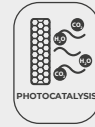

Filter units without a fan but with technology based on photocatalysis, especially designed for cleaning, disinfecting and purifying air in indoor spaces as well as material surfaces.

Characteristics:

- Aluminium profile structure.
- Covers with a high quality, 25 mm thick acoustic casing made of prefinished sheet.
- Side access panel for proper maintenance.

- Modular construction for use in combination with different air treatment units.
- Compatible with most existing aluminium profile type models: CJK/EC, CJK/FILTER/EC, UPC/EC, CJBX/AL, CJBD/AL, CJDXR/AL, UFRX/ALS...
- Devices with built-in high-efficiency photocatalysis technology.
- Positive and negative ionisation.
- Filtration stages: F7 + F9.
- Effective up to 40 linear metres of ducting.

Order code

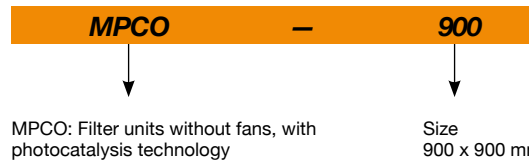

Technical characteristics

Model	Cross section (mm)		Approx. weight (Kg)	Maximum flow rate (m³/h)	Electrical consumption (W)
	Height	Width			
MPCO-490	490	490	53	1813	14
MPCO-500	500	500	60	1323	14
MPCO-550	550	550	61	2384	14
MPCO-605	605	605	68	2970	14
MPCO-680	680	680	74	3887	14
MPCO-700	700	700	111	2593	14
MPCO-855	855	855	127	6464	28
MPCO-900	900	900	178	3759	14
MPCO-1000	1000	1000	159	8983	28
MPCO-1195	1195	1195	221	10372	42
MPCO-1250	1250	1250	237	10372	42
MPCO-1450	1450	1450	284	15038	56
MPCO-1670	1670	1670	321	23338	84

Installation examples

Set-up next to a ventilation unit

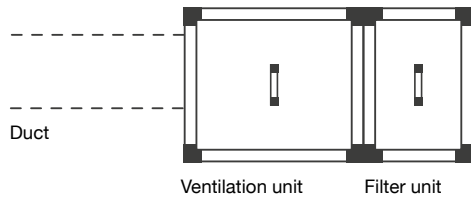

Set-up between ducts

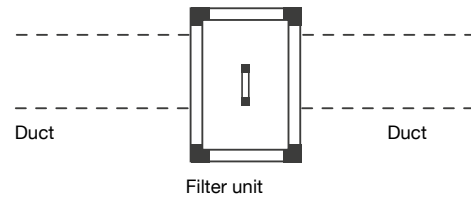

Dimensions mm

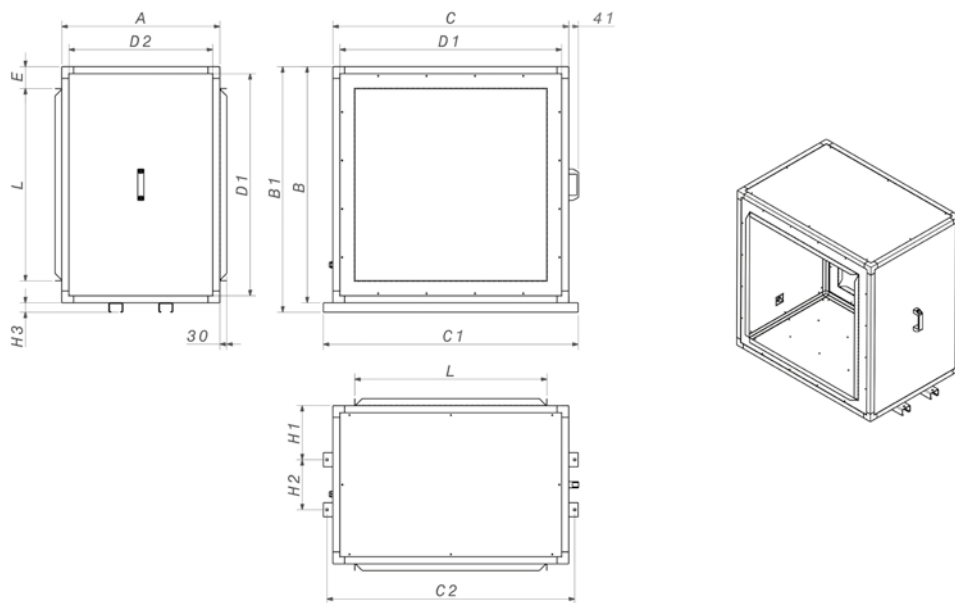

	A	B	B1	C	C1	C2	D1	D2	E	L	H1	H2	H3
MPCO-490	510	490	-	490	-	-	430	450	83.4	323.2	-	-	-
MPCO-500	500	500	-	500	-	-	420	420	58.4	383.2	-	-	-
MPCO-550	510	550	-	550	-	-	490	450	83.4	383.2	-	-	-
MPCO-605	510	605	-	605	-	-	545	450	106.9	391.2	-	-	-
MPCO-680	510	680	-	680	-	-	620	450	84.4	511.2	-	-	-
MPCO-700	700	700	-	700	-	-	620	620	94.4	511.2	-	-	-
MPCO-855	670	855	895	855	938	908	795	610	84.4	686.2	229	212	40
MPCO-900	900	900	-	900	-	-	820	820	106.9	686.2	-	-	-
MPCO-1000	670	1000	1040	1000	1080	1050	940	610	92.9	814.2	229	212	40
MPCO-1195	670	1195	1235	1195	1280	1245	1115	590	131.9	931.2	229	212	40
MPCO-1250	670	1250	1290	1250	1350	1320	1170	590	168.9	912.2	229	212	40
MPCO-1450	670	1450	1490	1450	1550	1520	1370	590	169.4	1111.2	229	212	40
MPCO-1670	670	1670	1710	1670	1770	1740	1590	590	137.75	1394.5	229	212	40

Accessories

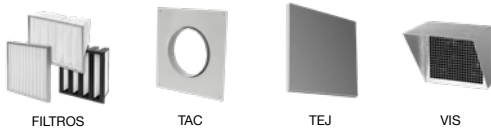

Load loss characteristic curves

Q= Flow rate in m³/h, m³/s and cfm Pe= Static pressure in mm H₂O, Pa and inwg

Filter modules: MPCO F7+F9

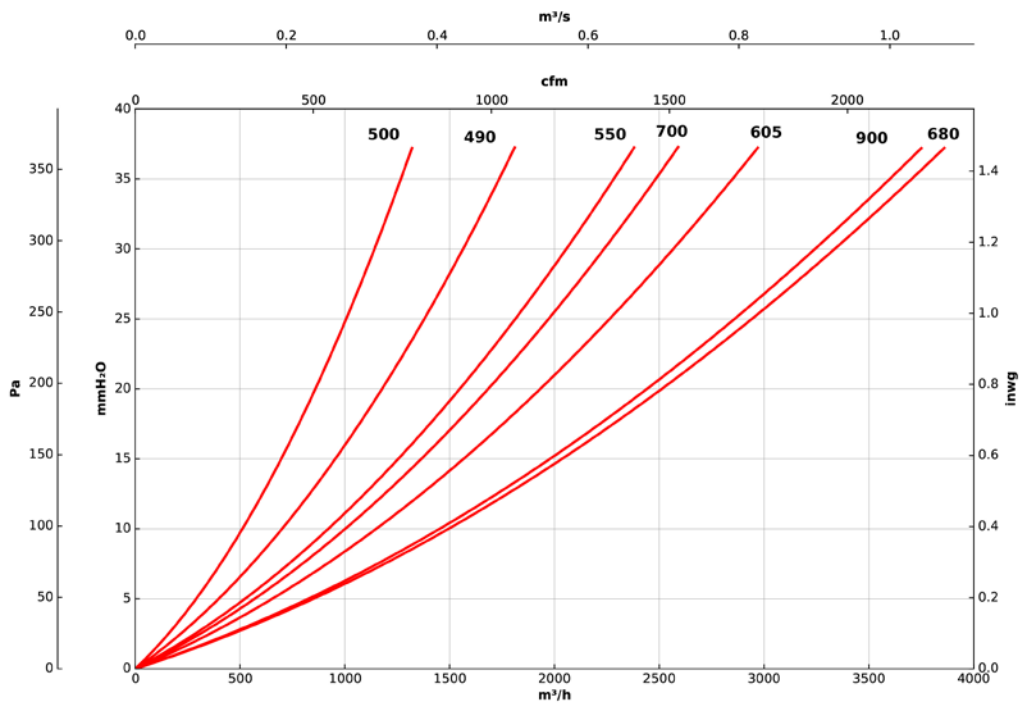

Filter modules: MPCO F7+F9

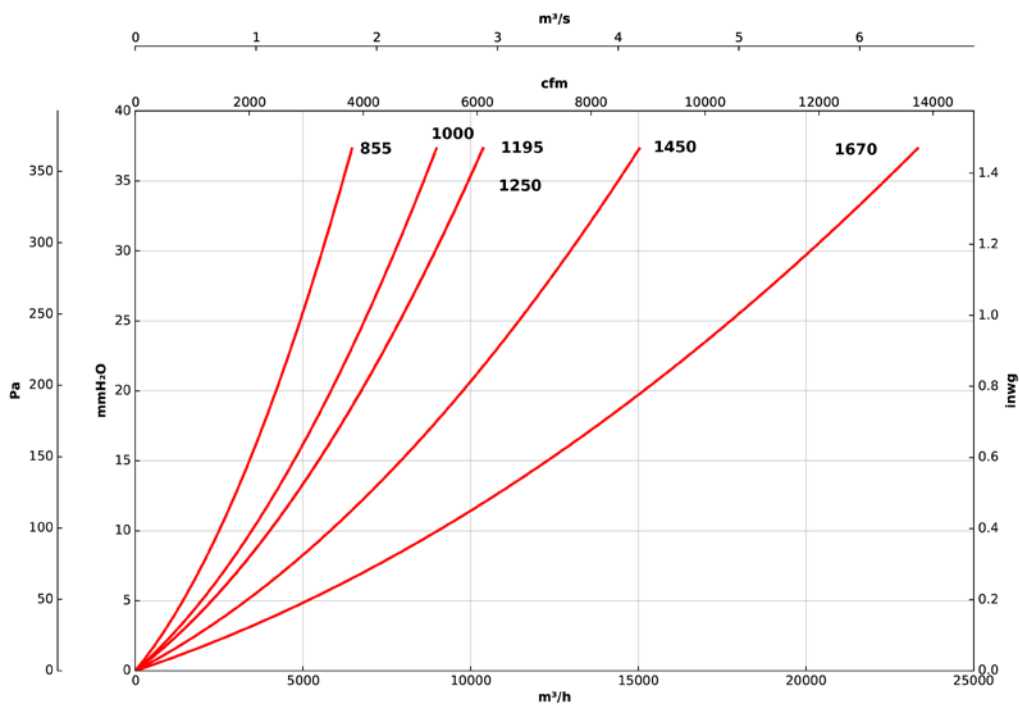

MFE

Filter units without fans, with high efficiency electrostatic filters

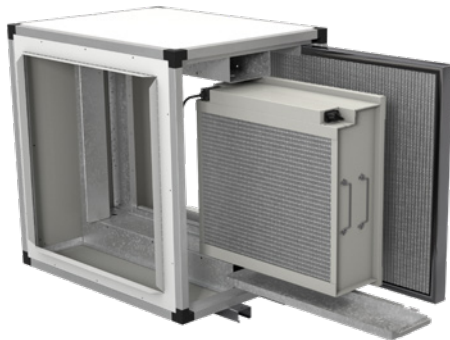
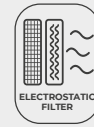

Filter units without a fan but with high efficiency electrostatic filters that are especially designed for cleaning, disinfecting and purifying indoor air at locations containing a high amount of grease or suspended particulate matter.

Characteristics:

- Aluminium profile structure.
- Covers with a high quality, 25 mm thick acoustic casing made of prefinished sheet.
- Inspection panel for maintenance and filter replacement (minimum recommended opening on the side of 1 m).

- Modular construction for use in combination with different air treatment units.
- Supply voltage at 230 V 50 Hz.
- Compatible with most existing aluminium profile type models: CJK/EC, CJK/FILTER/EC, UPC/EC, CJBX/AL, CJBD/AL, CJDXR/AL, UFRX/ALS...
- Washable, anti-grease pre-filter.
- High efficiency (95% ePM1) electrostatic filter device with built-in thermal sensor.
- Grease-collection trays.

Order code

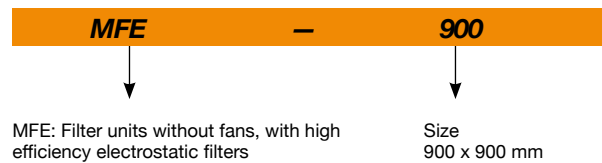

Filter characteristics

ELECTROSTATIC FILTER	ePM ₁				
	95%	90%	80%	70%	
Filtration class EN 779	-	-	F9	F8	F7
Air speed (m/s)	1	2	2.5	3	4
Air flow capacity (%)	40	50	65	75	100
Pressure drop (Pa)	10	17	24	37	64

Technical characteristics

Model	Cross section (mm)		Approx. weight (Kg)	Maximum flow rate (m ³ /h)	Electrical consumption (W)
	Height	Width			
MFE-490	490	490	45	700	9
MFE-500	500	500	41	700	9
MFE-550	550	550	50	700	9
MFE-605	605	605	60	900	9
MFE-680	680	680	73	2100	16
MFE-700	700	700	97	2100	16
MFE-855	855	855	118	3400	16
MFE-900	900	900	153	3400	16
MFE-1000	1000	1000	185	4900	43
MFE-1195	1195	1195	252	8400	64
MFE-1250	1250	1250	274	9320	64
MFE-1450	1450	1450	330	13600	64
MFE-1670	1670	1670	424	19500	109

Installation examples

Set-up next to a ventilation unit

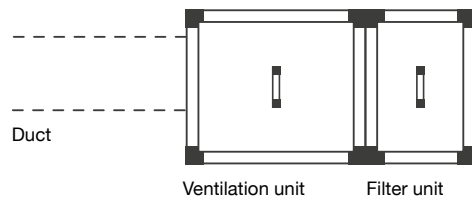

Set-up between ducts

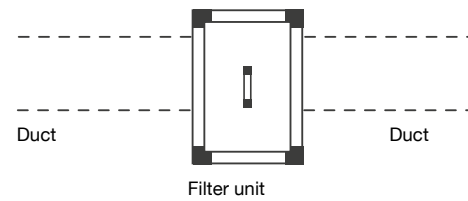

Dimensions mm

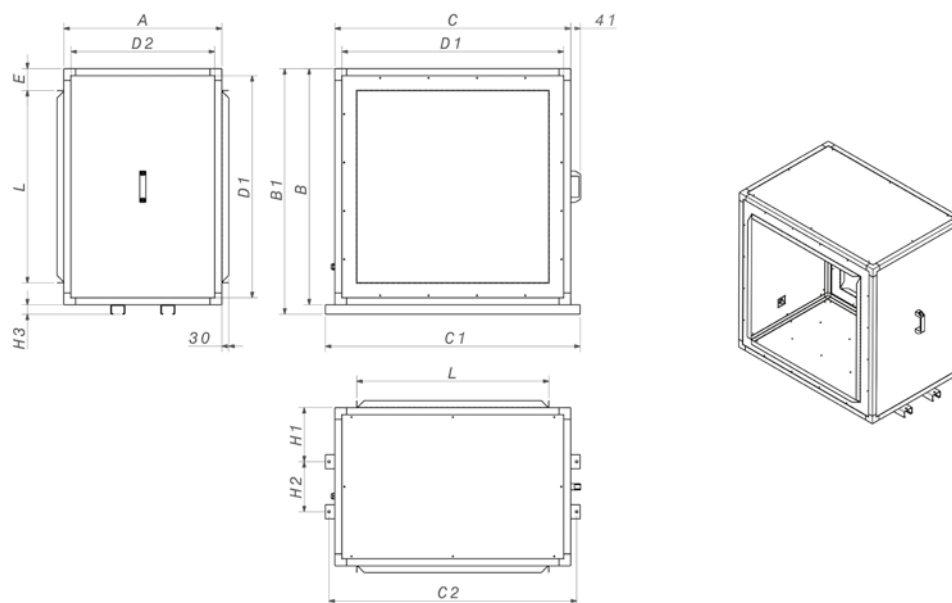

	A	B	B1	C	C1	C2	D1	D2	E	L	H1	H2	H3
MFE-490	510	490	-	490	-	-	430	450	83.4	323.2	-	-	-
MFE-500	500	500	-	500	-	-	420	420	58.4	383.2	-	-	-
MFE-550	510	550	-	550	-	-	490	450	83.4	383.2	-	-	-
MFE-605	510	605	-	605	-	-	545	450	106.9	391.2	-	-	-
MFE-680	510	680	-	680	-	-	620	450	84.4	511.2	-	-	-
MFE-700	700	700	-	700	-	-	620	620	94.4	511.2	-	-	-
MFE-855	670	855	895	855	938	908	795	610	84.4	686.2	229	212	40
MFE-900	900	900	-	900	-	-	820	820	106.9	686.2	-	-	-
MFE-1000	670	1000	1040	1000	1080	1050	940	610	92.9	814.2	229	212	40
MFE-1195	670	1195	1235	1195	1280	1245	1115	590	131.9	931.2	229	212	40
MFE-1250	670	1250	1290	1250	1350	1320	1170	590	168.9	912.2	229	212	40
MFE-1450	670	1450	1490	1450	1550	1520	1370	590	169.4	1111.2	229	212	40
MFE-1670	670	1670	1710	1670	1770	1740	1590	590	137.75	1394.5	229	212	40

Accessories

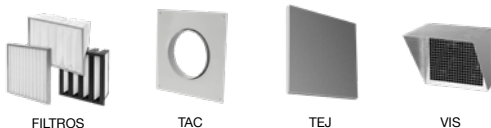

Load loss characteristic curves

Q= Flow rate in m³/h, m³/s and cfm Pe= Static pressure in mm H₂O, Pa and inwg

Filter modules: G2+FE

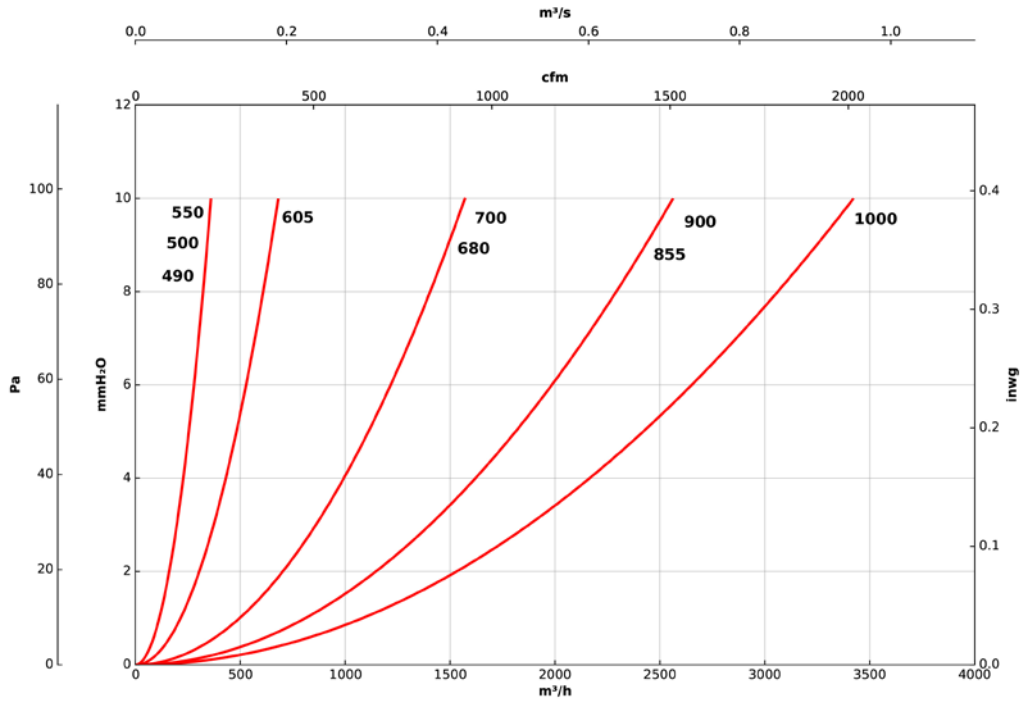

Filter modules: G2+FE

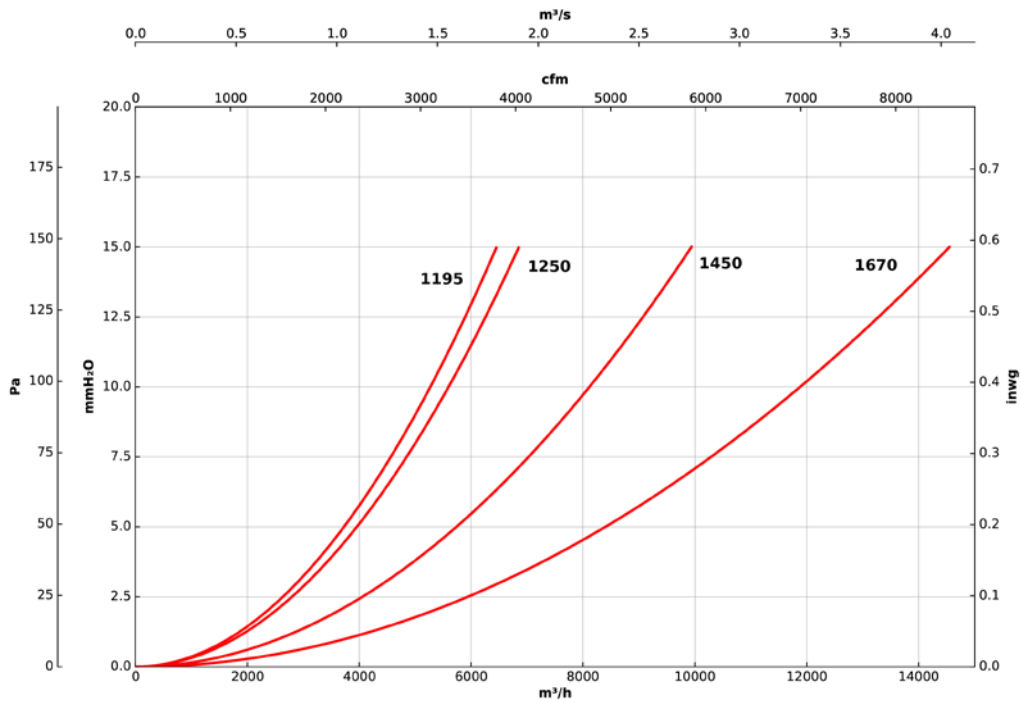

GERMICIDAL CHAMBERS

HEAT RECOVERY UNITS



UNIREC

High efficiency single zone heat recovery ventilators for domestic installations



Remote control



Designed to renew the air inside the home while minimising energy loss, and to supply clean air, due to their filters, which prevent particles entering from outside.

Characteristics:

- Reversible EC fan.
- Thermal efficiency of up to 90%.
- Equipped with G3 Filters.
- Compact ceramic heat exchanger.
- Easy installation. Adaptable to various wall thicknesses thanks to its telescopic duct.
- Automatic air intake grille. In the OFF position it remains closed to avoid air leaks.
- In heat recovery mode, the supply and extraction cycle takes 70 seconds.
- Duct length from 120 mm to 470 mm.

Control:

- Control panel built into the system.
- Remote control.
- Extraction position. Blow or heat recovery.
- Two speeds.
- Humidity control.
- Natural mode. Inlet grille open and fan stopped.
- Possibility of connecting several computers in a network.

Motor:

- Supply voltage from 100 V to 230 V 50/60 Hz.
- Built-in power cable.

Order code

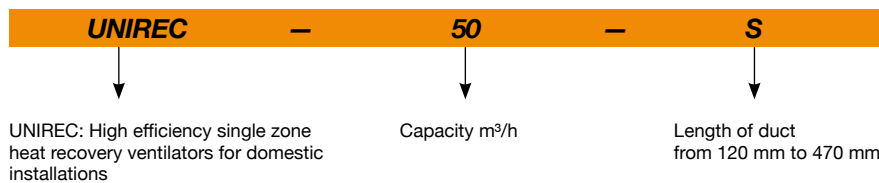

Technical characteristics

Model	Fans			Input voltage (V)	Frequency (Hz)	Maximum flow rate (m ³ /h)	Thermal efficiency (%)	LpA irradiated 3 m (dB (A))	Temperature of the air to be carried (°C)	Duct diameter (mm)	Length of duct (mm)
	Speed (r/min)	Current (A)	Power (W)								
UNIREC-50-S	1450	0.039	5.61	1x100-230	50/60	54	90	23	-20 a +50	150	120-470

Dimensions mm

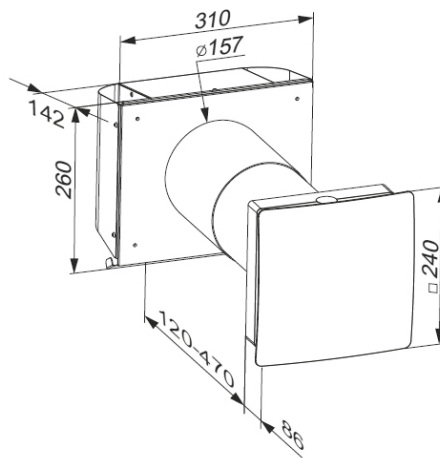

Working cycles in recovery mode

EXTRACTION (70 seconds)



During this cycle, the ceramic heat exchanger absorbs heat from the extracted air.

SUPPLY (70 seconds)



During this cycle, the heat exchanger provides heat to the air coming in from the outside.

Once this cycle has finished, the process of extraction starts again, and so on.

Installation examples

A: Machines working individually in heat recovery mode for a single room.

B: Machines working in a network, synchronised; while one performs the supply cycle, the other performs the extraction cycle, and so on.

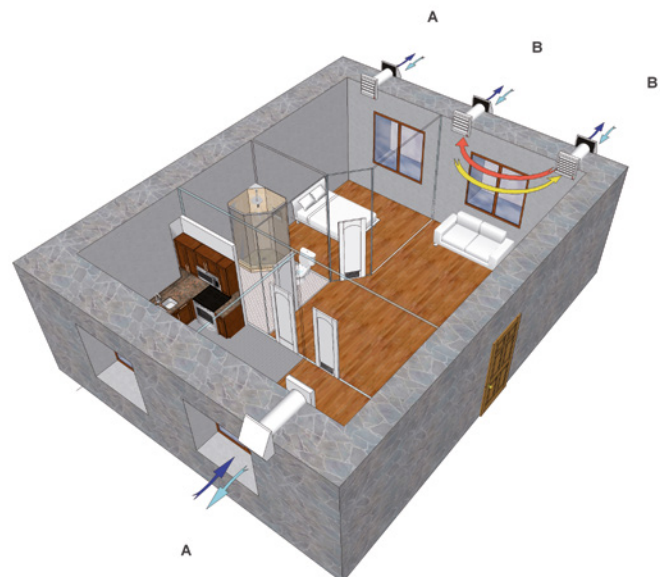

VENUS

High efficiency single zone heat recovery ventilators for residential installations



EC version control



High performance heat recovery ventilators to be installed inside residential buildings. With a low power consumption and heat recovery efficiency of up to 93%. For technical ceiling installation.

Finishing:

- Light expanded polypropylene body for low noise emission levels.
- Low profile models for false ceiling installation.
- 160 mm inlets/outlets (models 150 and 300) and 250 mm inlets/outlets (models 500 and 700).

Features of all versions:

- Counterflow heat exchanger.

- Flow adjustment capacity according to external control signal.
- Condensate drain with built-in siphon.
- Access to filters and condensate drainage from above and below.

Additional features of the EC version:

- Operation compatible 50/60 Hz.
- Air supply filters with F7 efficiency level.
- High efficiency EC fans.
- Digital remote control panel included.
- Antifreeze protection and free cooling.
- Multizone control through the possibility of connecting CO₂, PIR (presence) and HR (relative humidity) sensors. ALL / NOTHING type signal.

Version	AC	EC
Motor Type	AC	EC (high efficiency)
Control panel	Manual selector CP-SM-V-4 (accessory not included)	Digital (included)
Control panel cable	4-wire, 230V (not included)	4-wire PTPM-RJ12 10 m Included/ Maximum 30 m
No. of fan speeds	3	3
Supply/Extraction filter efficiency	F5 / G4	F7 / G4
Alarm management	YES	YES
Flow control via external control	YES	YES
Each fan adjusted precisely	-	YES
Control of closing hatches	-	YES (hatches not supplied)
Connections to 5 optional sensors	-	Types: CO ₂ / PIR / HR
Sensor power supply	-	15V DC
External control to force maximum flow	-	YES
Free cooling by stopping 1 fan	-	YES (with timer setting)
Antifreeze protection	-	YES
Adjustable filter change alarm	-	YES
LED filter state control	YES	YES

Order code

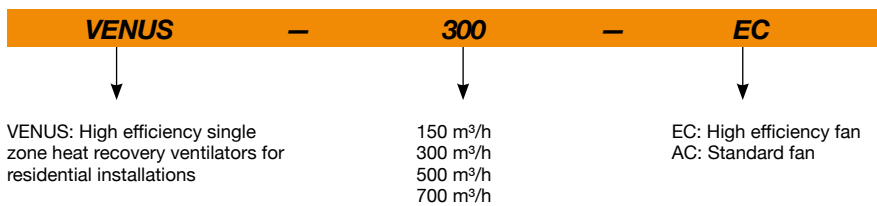

Technical characteristics

Model	Maximum flow rate (m ³ /h)	Total power (W)	Recovery efficiency (%)	Maximum admissible current (A) 220-240V	Irradiated sound level at 3 m dB (A)	Approx. weight (Kg)	According ErP
VENUS-150-AC	185	105	93	2 x 0.23	37.3	17.4	2018
VENUS-150-EC	175	65	93	2 x 0.14	37.7	17.2	2018
VENUS-300-AC	265	145	93	2 x 0.32	38.9	19.5	2018
VENUS-300-EC	315	170	93	2 x 0.37	43.5	19.3	2018
VENUS-500-AC	515	230	93	2 x 0.50	47.1	35	2018
VENUS-500-EC	535	220	93	2 x 0.48	45.8	35.5	2018
VENUS-700-AC	650	270	93	2 x 0.59	42.9	40	2018
VENUS-700-EC	785	430	93	2 x 0.93	53.6	40.7	2018



Erp. (Energy Related Products)

Information on Directive 2009/125/EC can be downloaded from the SODECA website or the QuickFan selector programme.

Characteristic curves

Q= Flow rate in m³/h, m³/s and cfm

Pe= Static pressure in mm H₂O, Pa and inwg

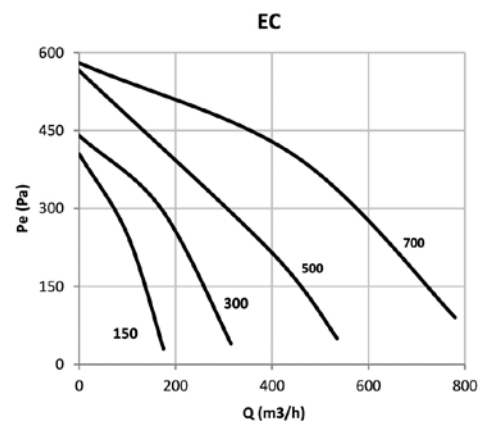
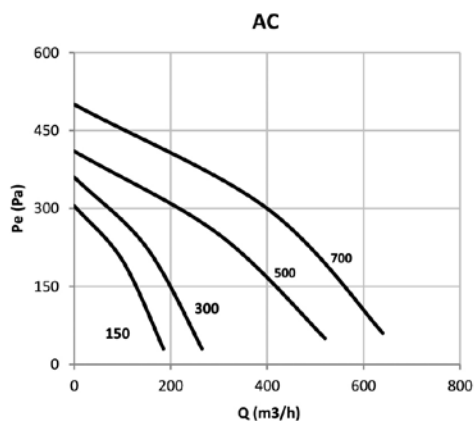

Installation

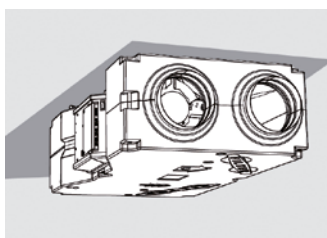

In false ceilings

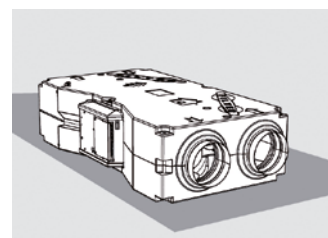

Floor-mounted

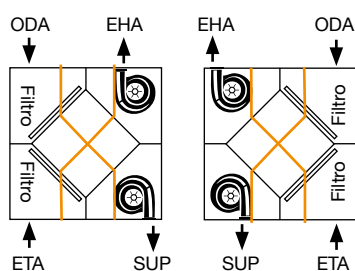

Configuration may be chosen by turning the machine through 180°. Access to filters and drainage from above and below.

ODA: Fresh outdoor air / SUP: Air impulsion to the premise / EHA: Exit of exhaust air / ETA: Air extraction from premises

Dimensions mm

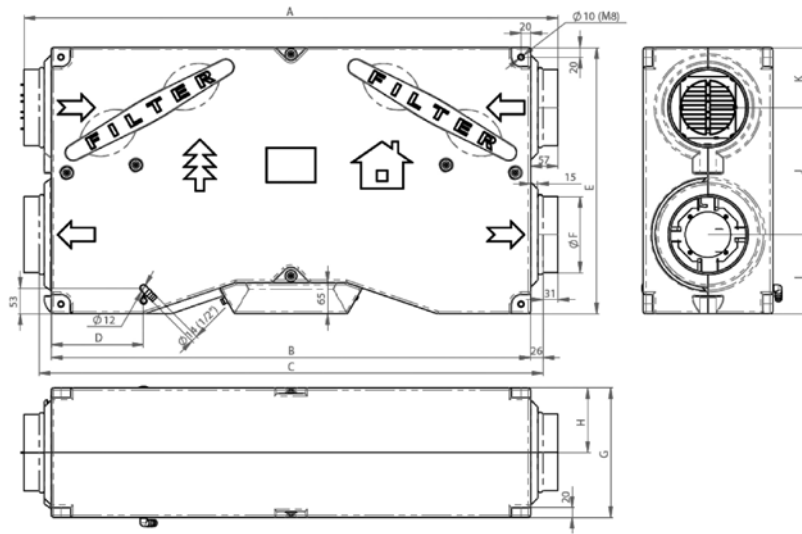

	A	B	C	D	E	ØF	G	H	I	J	K
VENUS 150 / 300	1114	1000	1051	193	555	159	270	135	165	265	125
VENUS 500 / 700	1505	1391	1441	248	846	249	360	180	235	420	190

Accessories



CP-SM-V-4



RH SENSOR



PIR SENSOR



CO2 sensor



Compuerta de cierre



SERVO DE COMPUERTA



FILTROS



CABLE PTPM-RJ12

REB

Heat recovery units with EC Technology motor and built-in by-pass



REB-15...120



REB-180...270



REB-400...600

Heat recovery units with EC Technology motor and built-in by-pass, low power consumption and heat recovery efficiency of over 86%.

Characteristics:

- Counterflow heat exchanger.
- With 100% automatic by-pass (except model REB-15).
- Low consumption fans with built-in regulation.
- Lateral maintenance access.
- Operation compatible 50/60 Hz.
- Particle filters with efficiencies depending on models.

Finishing on models 15 to 120:

- Equipment structure made of anti-corrosive galvanised sheet steel.
- Anti-condensation foam coating.
- Interior in lightweight expanded

polypropylene and with low noise emissions.

- Low profile models for false ceiling installation.

Finishing on models 180 and 270:

- Aluminium profile and prefinished sheet steel structure with 25 mm thick thermal and acoustic insulation panels.
- Low profile models for false ceiling installation.

Finishing on REB-400 and REB-600 models:

- Aluminium profile and prefinished sheet steel structure with 30 mm thick thermal and acoustic insulation panels.
- For installation in technical rooms.
- Control compatible with MODBUS RTU.

Order code

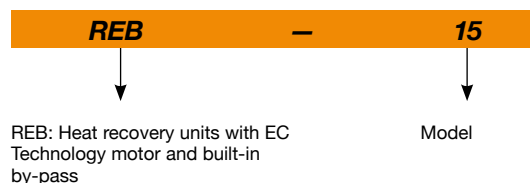

Characteristics based on size

	REB-15	REB-25..120	REB-180..270	REB-400..600
Supply standard filters	G4	G4	G4+F9	F6+F8
Extraction standard filters	G4	G4	G4	F6
Second filter stage integrated in the fresh air circuit	-	-	YES	YES
Free cooling function 100% of flow	-	-	YES	YES
Heat recovery type	Enthalpy	Enthalpy	Enthalpy	Sensitive
Condensate exhaust	-	-	-	YES
Built-in pressure switches for filter condition control	-	-	YES	-
Maintenance switch	-	-	YES	YES
Compatible with SI-VOC+HUMEDAD control	YES	YES	YES	-
Control by MODBUS RTU	-	-	-	YES

Technical characteristics

Model	Maximum flow rate	Total power	Maximum admissible current (A)		Recovery efficiency	Irradiated sound level at 5 m	Approx. weight	According ErP
	(m ³ /h)		(W)	220-240V II				
REB-15	180	60	0.26		72	38	18	Excluded
REB-25	300	70	0.30		81	35	31	2018
REB-40	480	90	0.39		82	37	39	2018
REB-60	720	140	0.61		80	39	55	2018
REB-80	960	300	1.30		82	41	72	2018
REB-120	1440	325	1.41		79	42	91	2018
REB-180	1770	750	5.80		73	53	150	2018
REB-270	2570	1000	7.20		73	53	180	2018
REB-400	4440	4800		8.00	88	61	375	2018
REB-600	6000	7800		12.40	88	61	465	2018



Erp. (Energy Related Products)

Information on Directive 2009/125/EC can be downloaded from the SODECA website or the QuickFan selector programme.

Accessories

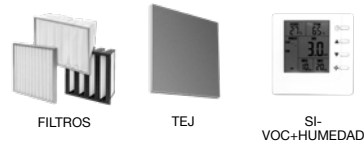

Characteristic curves

Q= Flow rate in m³/h, m³/s and cfm

Pe= Static pressure in mm H₂O, Pa and inwg

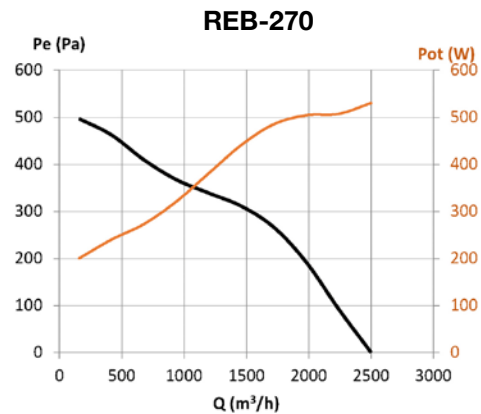
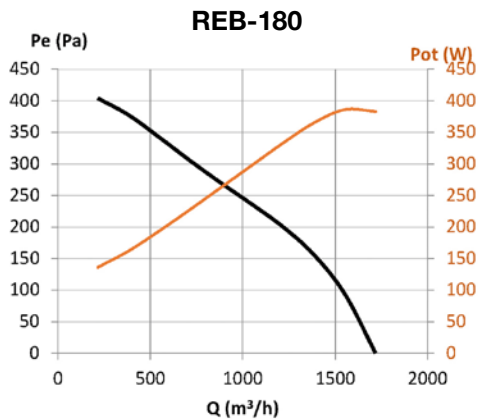
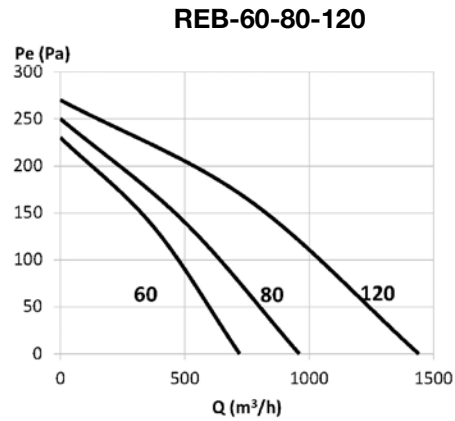
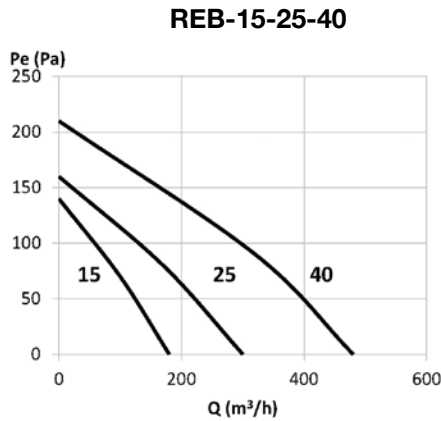

Characteristic curves

Q= Flow rate in m³/h, m³/s and cfm

Pe= Static pressure in mm H₂O, Pa and inwg

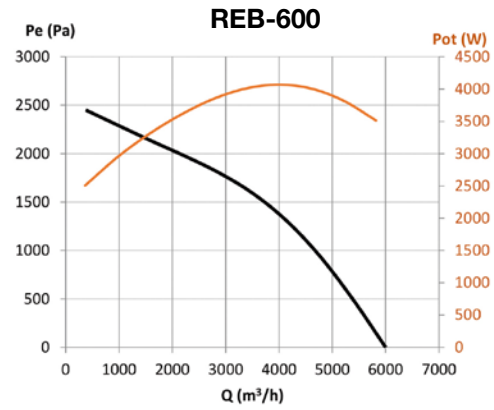
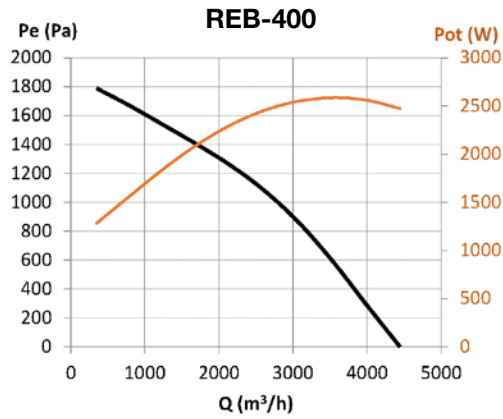

Dimensions mm

REB-15...120

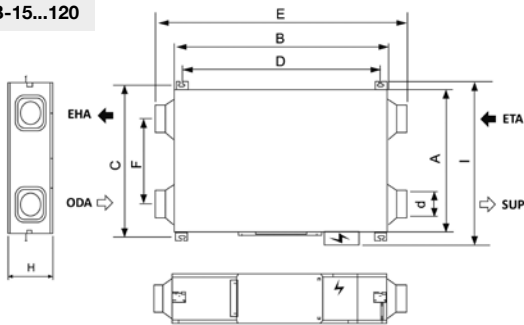

REB-180...270

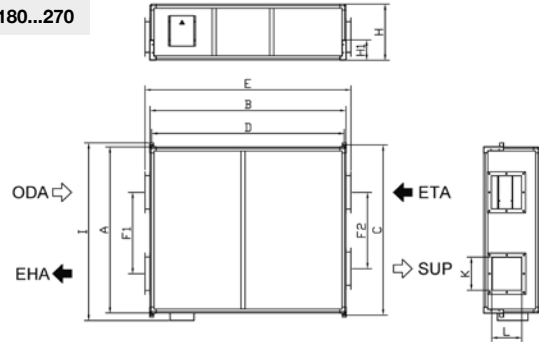

REB-400...600

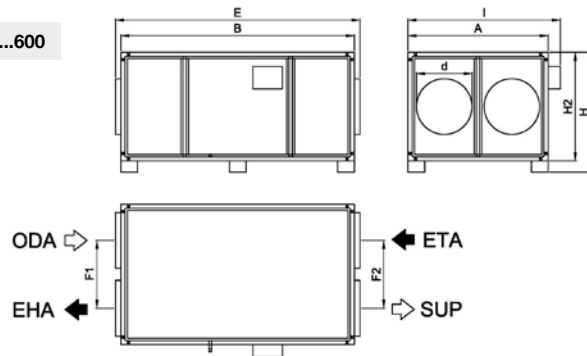

	A	B	C	D	E	F	F1	F2	H	H1	H2	I	d	K	L
REB-15	510	883	560	813	1043	345	-	-	272	-	-	620	97	-	-
REB-25	675	890	735	820	1070	335	-	-	280	-	-	790	146	-	-
REB-40	813	888	863	818	1068	480	-	-	280	-	-	930	146	-	-
REB-60	995	970	1055	910	1130	728	-	-	313	-	-	1065	197	-	-
REB-80	883	1325	953	1255	1485	429	-	-	390	-	-	1000	247	-	-
REB-120	1132	1328	1202	1258	1488	680	-	-	395	-	-	1250	247	-	-
REB-180	1240	1630	1280	1596	1730	-	554	554	558	200	-	1355	-	230	260
REB-270	1654	1950	1695	1916	2050	-	810	760	558	200	-	1769	-	330	300
REB-400	1260	1900	-	-	2000	-	600	600	818	-	718	1372	450	-	-
REB-600	1260	2100	-	-	2200	-	600	600	1075	-	975	1372	500	-	-

ODA: Fresh outdoor air / SUP: Air impulsion to the premise / EHA: Exit of exhaust air / ETA: Air extraction from premises

REB-HEPA



Heat recovery units with EC Technology motor, built-in by-pass and HEPA filter



Heat recovery units with EC Technology motor, built-in by-pass and HEPA filter. Low power consumption and heat recovery efficiency of up to 82%.

Characteristics:

- Counterflow heat exchanger.
- With 100% automatic by-pass.
- Low consumption fans with built-in regulation.
- Lateral maintenance access.
- Operation compatible 50/60 Hz.

- HEPA H13 type filters with a filtration efficiency of 99.95%.

Finish:

- Galvanised sheet steel structure.
- Anti-condensation foam coating.
- Interior in lightweight expanded polypropylene and with low noise emissions.
- Low profile models for false ceiling installation.

Order code

REB-HEPA — 40

REB-HEPA: Heat recovery units with EC Technology motor, built-in by-pass and HEPA filter

Model

Characteristics

Motor Type	EC
Fan speeds	3
Supply standard filters	HEPA H13
Extraction standard filters	G4
Side access to filters	YES
Free cooling function by means of a motorised by-pass	YES
Heat recovery type	Enthalpy
Compatible with SI-VOC+HUMEDAD control	YES

Technical characteristics

Model	Maximum flow rate (m ³ /h)	Total power (W)	Maximum admissible current (A)	Recovery efficiency (%)	Irradiated sound level at 5 m dB (A)	Approx. weight (Kg)	According ErP
REB-HEPA-40	400	115	0.7	82	38	39	Excluded
REB-HEPA-60	600	150	0.9	80	40	55	2018
REB-HEPA-80	800	320	1.5	82	42	72	2018
REB-HEPA-120	1100	360	1.8	79	43	91	2018



Erp. (Energy Related Products)

Information on Directive 2009/125/EC can be downloaded from the SODECA website or the QuickFan selector programme.

Accessories

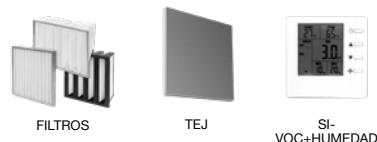

Dimensions mm

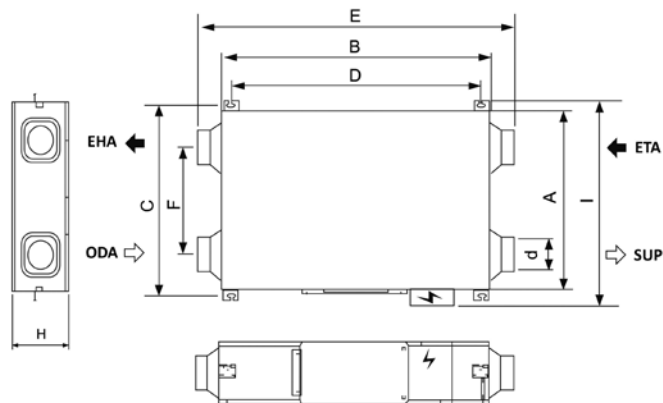

	A	B	C	D	E	F	H	I	d
REB-HEPA-40	807	984	864	913	1176	482	273	903	143
REB-HEPA-60	1007	1066	1055	1008	1230	728	322	1135	195
REB-HEPA-80	882	1402	940	1335	1565	431	400	1010	245
REB-HEPA-120	1132	1402	1190	1335	1565	681	400	1260	245

ODA: Fresh outdoor air / SUP: Air impulsion to the premise / EHA: Exit of exhaust air / ETA: Air extraction from premises

Characteristic curves

Q= Flow rate in m³/h, m³/s and cfm

Pe= Static pressure in mm H₂O, Pa and inwg

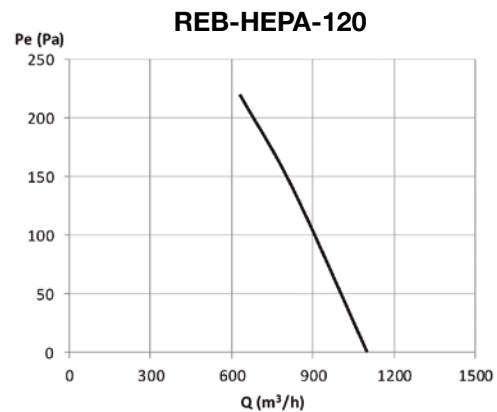
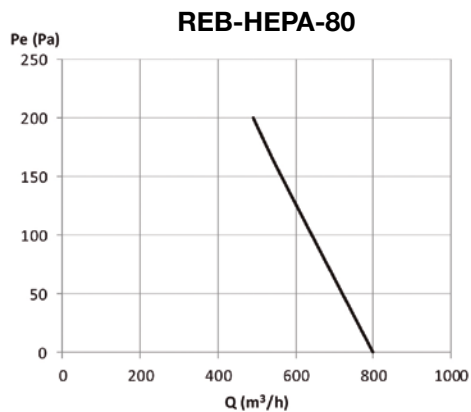
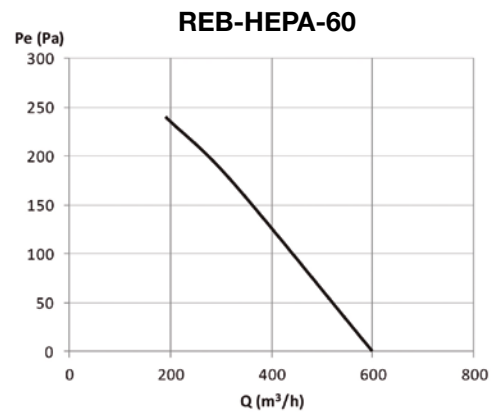
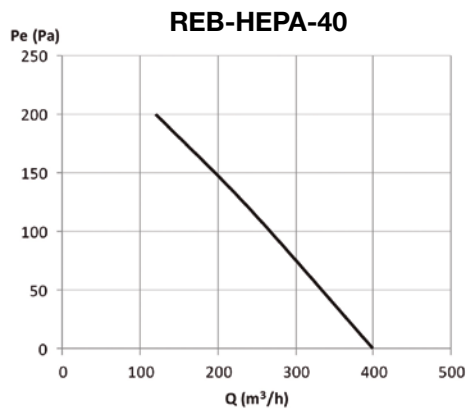

RECUP/EC-BS



Heat recovery units with counter flow plate exchanger, automatic control and EC Technology motors, for installation in false ceilings

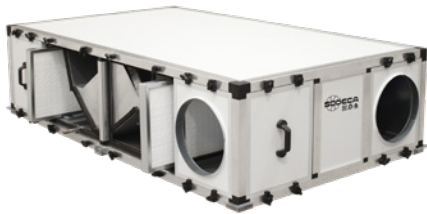

Common features:

- EC type Plug Fan adjustable 0-10 V.
- Built-in maintenance disconnect switch.
- Thermal efficiency of the equipment 85-90%.
- Structure with high quality reinforced aluminum profiles.
- Panels with a 25 mm thick thermal and acoustic insulation; exterior made of prefinished sheet.
- EPS type panels with thermal bridge break.
- High efficiency filtration:
 - M6 + F8.
 - F7 + F9.
- Broad access for maintenance.
- Free cooling with motorized damper to perform BY-PASS.
- Condensation collection tray and drain.

- STOP/START and speed control available through control panel or external contacts.
- Built-in temperature and humidity sensors.
- Filters condition check by means of built-in pressure switches.
- Fault alarm management and shutdown due to fire alarm.
- Compatible with MODBUS RTU.

Finish:

- Aluminium frame and external prefinished sheet structure.
- 25 mm thermal and acoustic insulation panels.
- Low profile models for false ceiling installation.
- Interchangeable nozzles for better adaptation.

Built-in control box:

- Control for free cooling through motorized BY-PASS.
- Fan speed control by manual selection or by optional external sensors (CO2 or pressure).
- Integrated control system with remote control panel.

On request:

- External battery modules for air treatment.
- Filters with special efficiencies.
- Modules with UVc germicidal chamber.

Order code

RECUP/EC-BS – 800 – BS – M6+F8

RECUP/EC-BS: Heat recovery units with counter flow plate exchanger, automatic control and EC Technology motors, for installation in false ceilings

Size

Horizontal ducts and installation in false ceilings

Filters M6+F8
Filters F7+F9

Characteristics based on size

	RECUP/ EC-800-BS	RECUP/ EC-1200-BS	RECUP/ EC-1600-BS	RECUP/ EC-2100-BS	RECUP/ EC-2700-BS
Supply filter (ODA)	M6+F8 / F7+F9	M6+F8 / F7+F9	M6+F8 / F7+F9	M6+F8 / F7+F9	M6+F8 / F7+F9
Extraction filter (ETA)	M6	M6	M6	M6	M6
Free cooling function by means of a motorised by-pass	YES	YES	YES	YES	YES
Panel thickness	25 mm	25 mm	25 mm	25 mm	25 mm
Condensate exhaust	YES	YES	YES	YES	YES
Built-in pressure switches for filter condition control	YES	YES	YES	YES	YES
Safety and maintenance switch	YES	YES	YES	YES	YES
Built-in control panel	YES	YES	YES	YES	YES

Technical characteristics

Model	Nominal flow rate (m ³ /h)	Recovery unit efficiency (%)	Available pressure (Pa)	Nominal power (kW)	Nominal current (A)	Voltage 50/60 Hz (V)	Irradiated sound level at 5 m dB (A)	Approx. weight (Kg)	According ErP
RECUP/EC-800-BS	800	86.5	70	0.39	2.91	1/230	45	78	2018
RECUP/EC-1200-BS	1200	86.8	70	0.32	1.16	1/230	34	105	2018
RECUP/EC-1600-BS	1600	86.2	100	0.53	2.11	1/230	40	178	2018
RECUP/EC-2100-BS	2100	88.0	100	0.76	3.14	1/230	43	216	2018
RECUP/EC-2700-BS	2700	86.9	100	1.23	5.17	1/230	50	216	2018



Erp. (Energy Related Products)

Information on Directive 2009/125/EC can be downloaded from the SODECA website or the QuickFan selector programme.

Dimensions mm

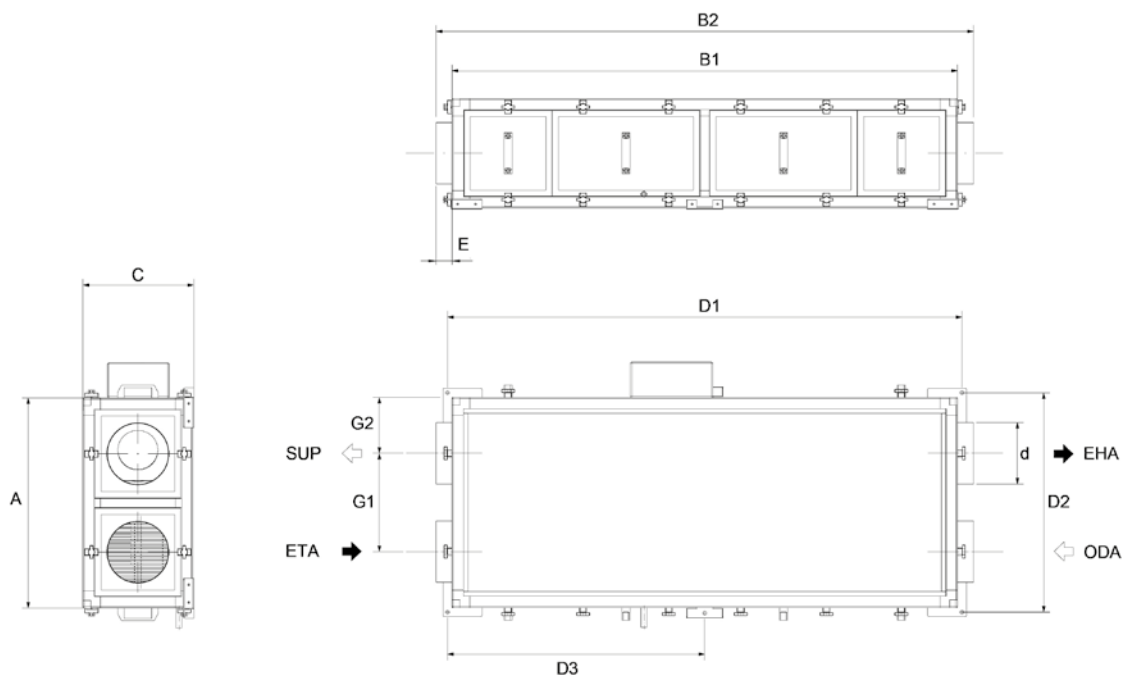

	A	B1	B2	C	D1	D2	D3	E	G1	G2	d
RECUP/EC-800-BS	684	1644	1694	357	1664	704	832	25	320	182	200
RECUP/EC-1200-BS	1124	1890	1940	480	1910	1144	955	25	695	214	315
RECUP/EC-1600-BS	1250	1970	2020	480	1990	1270	995	25	781	235	355
RECUP/EC-2100-BS	1250	2198	2248	620	2218	1270	1109	25	736	257	400
RECUP/EC-2700-BS	1250	2198	2248	620	2218	1270	1109	25	736	257	400

ODA: Fresh outdoor air / SUP: Air impulsion to the premise / EHA: Exit of exhaust air / ETA: Air extraction from premises

Accessories



FILTROS

TEJ

SI-PRESOSTATO

SI-CO2 IND

CG

Characteristic curves

Q= Flow rate in m³/h, m³/s and cfm

Pe= Static pressure in mm H₂O, Pa and inwg

RECUP/EC-800-BS

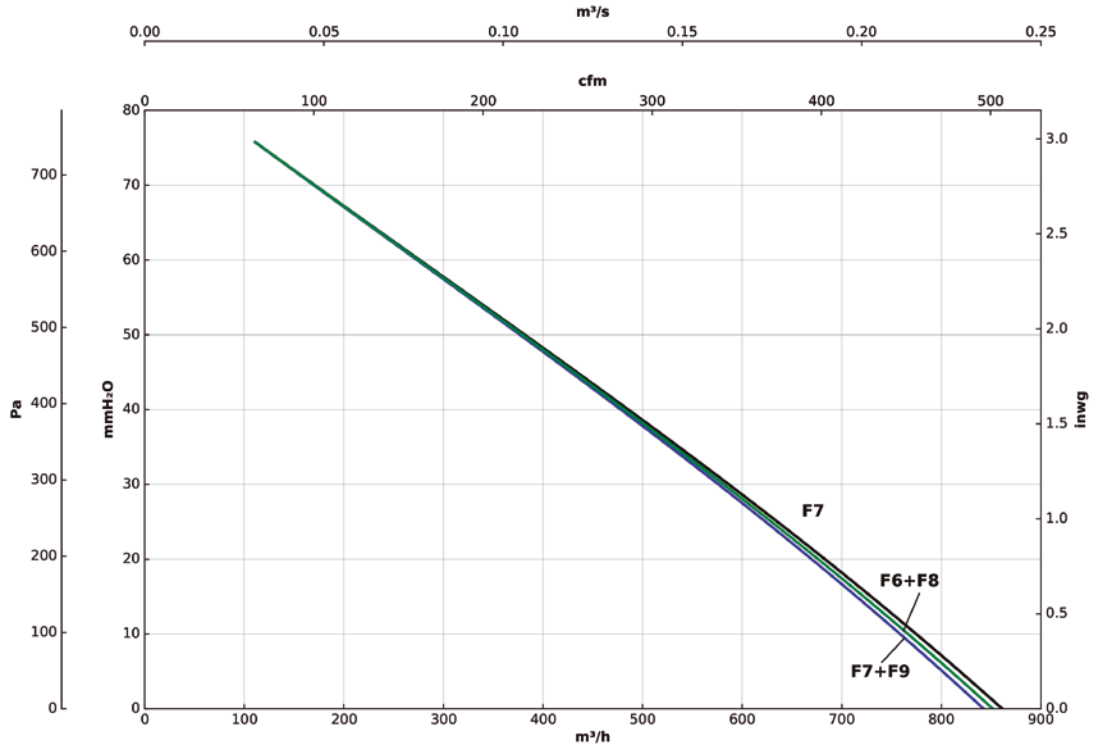

RECUP/EC-1200-BS

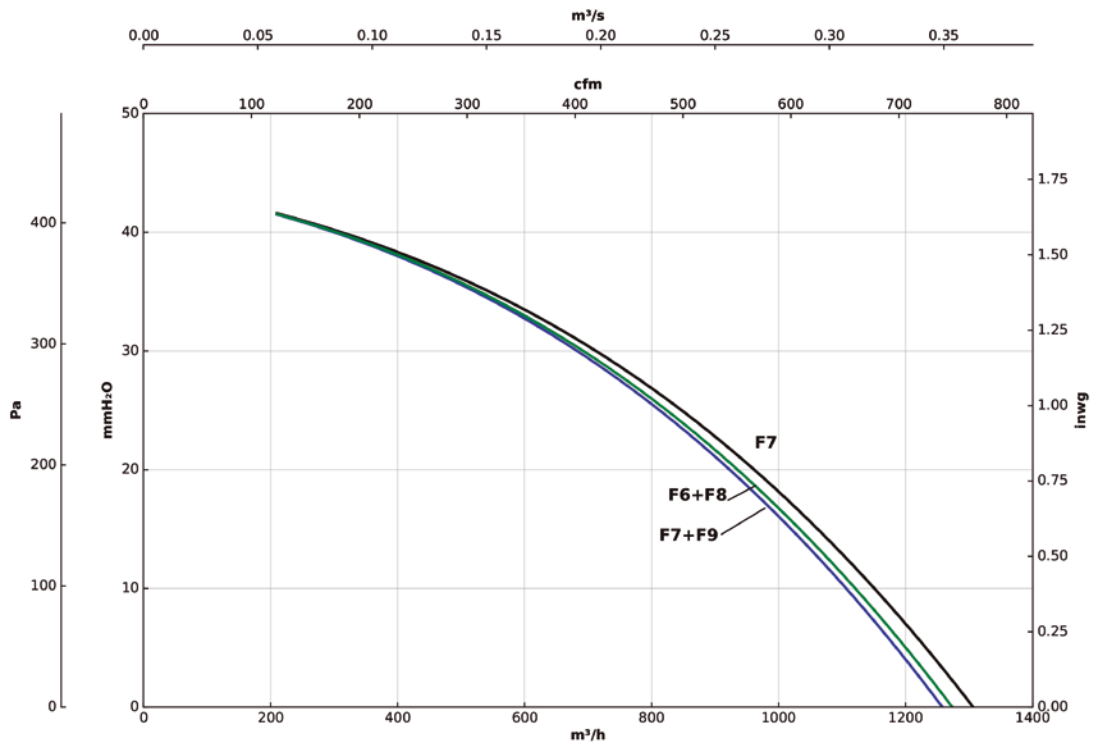

Characteristic curves

Q= Flow rate in m³/h, m³/s and cfm

Pe= Static pressure in mm H₂O, Pa and inwg

RECUP/EC-1600-BS

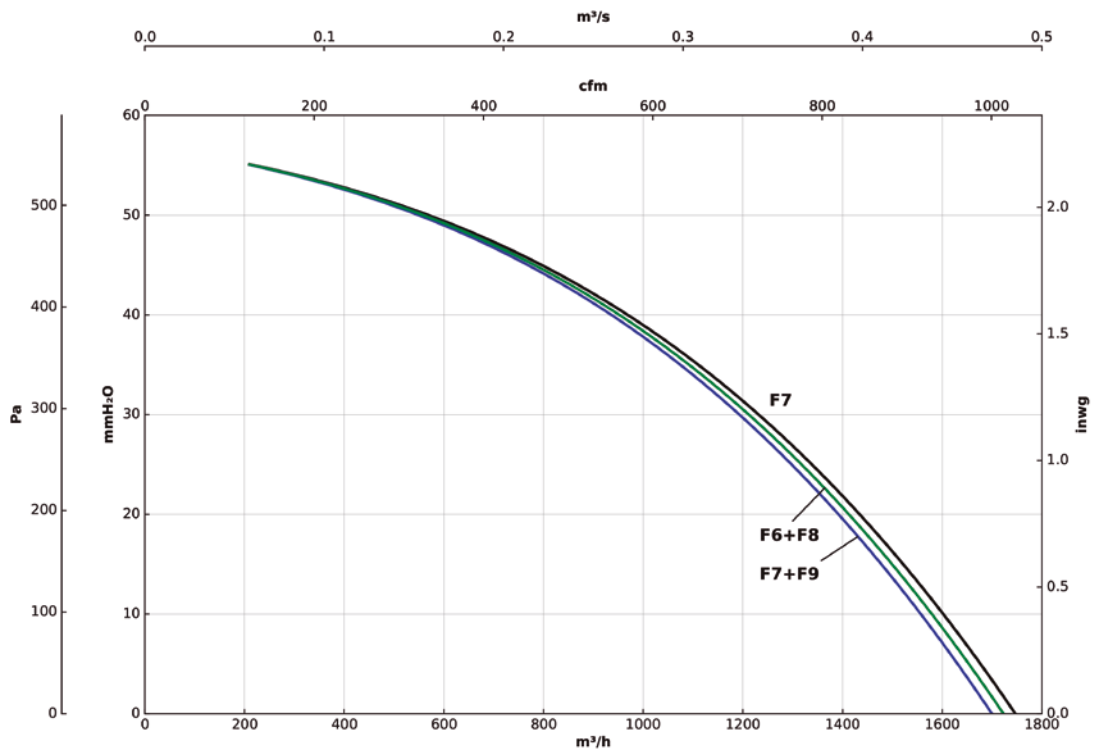

RECUP/EC-2100-BS

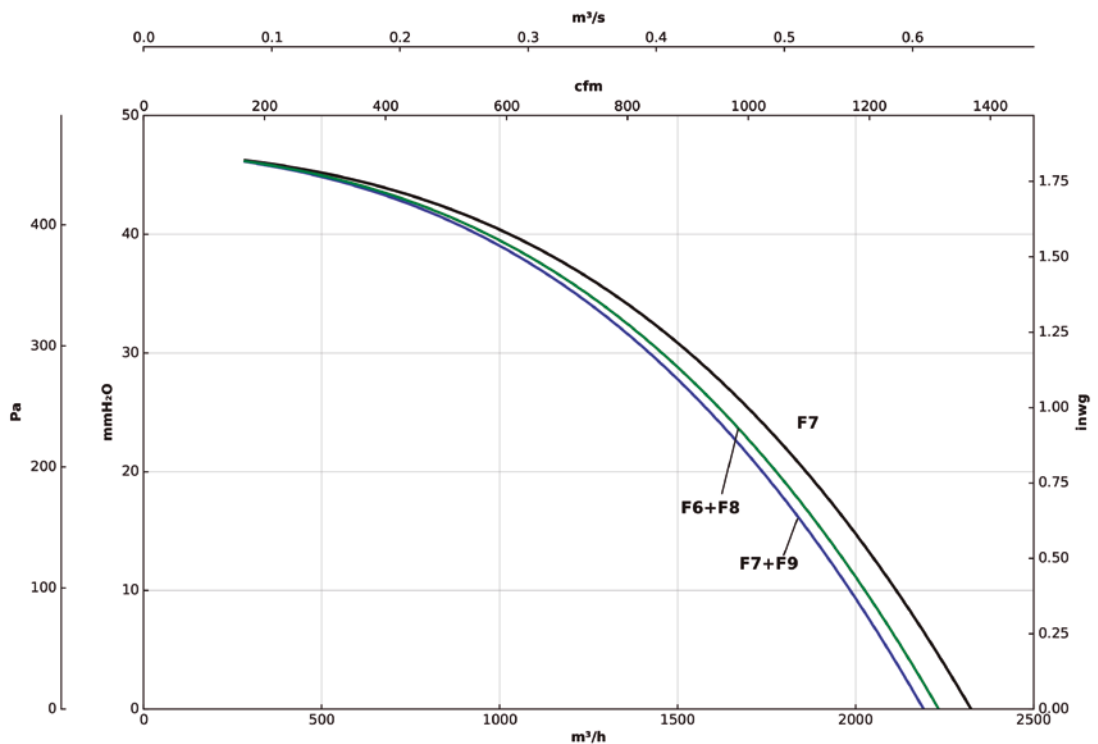

Characteristic curves

Q= Flow rate in m³/h, m³/s and cfm

Pe= Static pressure in mm H₂O, Pa and inwg

RECUP/EC-2700-BS

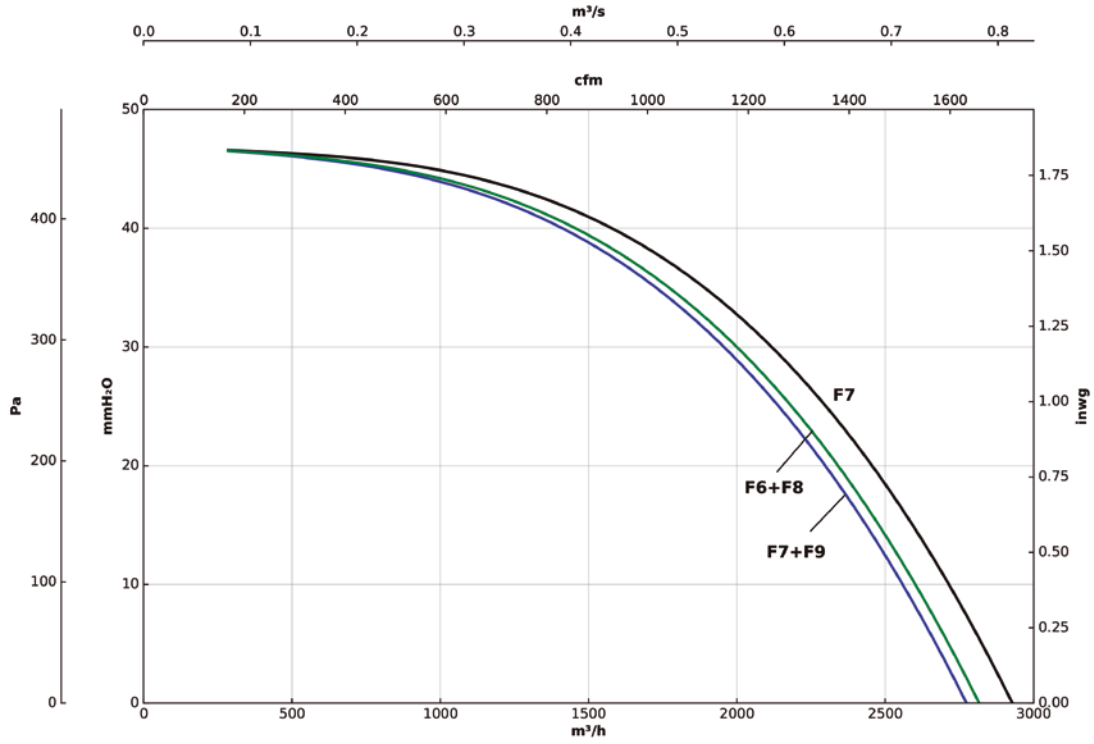

Efficiency curves

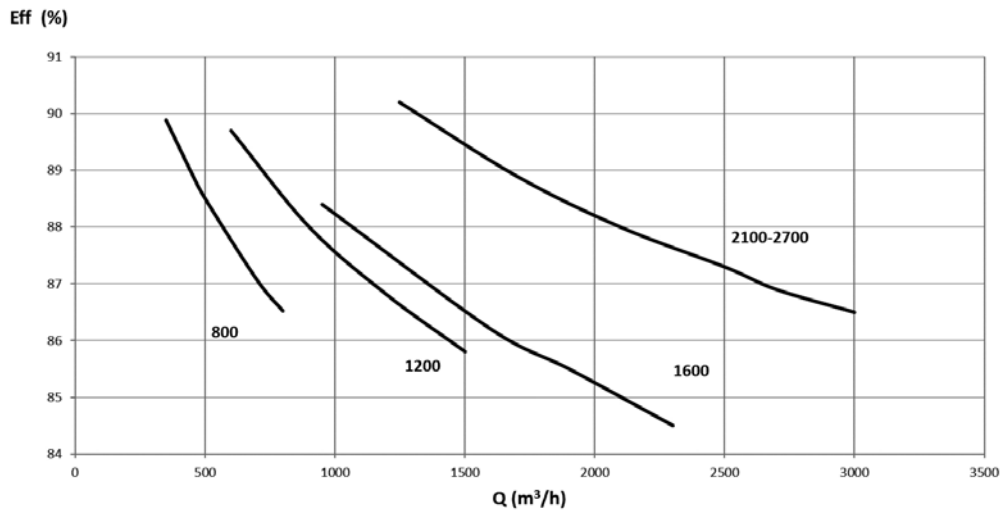

RECUP/EC-H

Heat recovery units with counter flow exchanger, automatic control and EC Technology motors, for installation on a roof or in a plant room



Common features:

- EC type Plug Fan adjustable 0-10 V.
- Built-in maintenance disconnect switch.
- Thermal efficiency of the equipment 85-90%.
- Structure with high quality reinforced aluminum profiles.
- Panels with thermal and acoustic insulation, exterior in pre-lacquered sheet.
- EPS type panels with thermal bridge break.
- G4 pre-filter + M6 or F7 filter in the air supply.
- High efficiency filtration F8 or F9 in the air supply.
- Broad access for maintenance.
- Free cooling with motorized damper to perform BY-PASS.
- Condensation collection tray and drain.

Built-in control box:

- Control for free cooling through motorized BY-PASS.
- Fan speed control by manual selection or by optional external sensors (CO2 or pressure).

- Integrated control system with remote control panel.
- STOP/START and speed control available through control panel or external contacts.
- Built-in temperature and humidity sensors.
- Filters condition check by means of built-in pressure switches.
- Fault alarm management and shutdown due to fire alarm.
- Compatible with MODBUS RTU.

Finish:

- Structure in aluminum profiles and pre-lacquered outer sheet.
- 25 mm thermal and acoustic insulation panels up to model 2700.
- 50 mm thermal and acoustic insulation panels from model 3300.

On request:

- External battery modules for air treatment.
- Filters with special efficiencies.
- Modules with UVc germicidal chamber.

Order code

RECUP/EC-H – 1200 – H – M6+F8

RECUP/EC-H: Heat recovery units with counter flow exchanger, automatic control and EC Technology motors, for installation on a roof or in a plant room

Size

Horizontal ducts and installation on roofs or in technical rooms

Filters M6+F8
Filters F7+F9

Characteristics based on size

	RECUP/ EC-1200-H	RECUP/ EC-1600-H	RECUP/ EC-2100-H	RECUP/ EC-2700-H
Supply filter (ODA)	G4+M6/F7	G4+M6/F7	G4+M6/F7	G4+M6/F7
Impulsion filter (SUP)	F8/F9	F8/F9	F8/F9	F8/F9
Extraction filter (ETA)	M6	M6	M6	M6
Free cooling function by means of a motorised by-pass	YES	YES	YES	YES
Panel thickness	25 mm	25 mm	25 mm	25 mm
Condensate exhaust	YES	YES	YES	YES
Built-in pressure switches for filter condition control	YES	YES	YES	YES
Safety and maintenance switch	YES	YES	YES	YES
Built-in control panel	YES	YES	YES	YES

Characteristics based on size

	RECUP/ EC-3300-H	RECUP/ EC-4500-H	RECUP/ EC-6000-H	RECUP/ EC-8000-H	RECUP/ EC-10000-H
Supply filter (ODA)	G4+M6/F7	G4+M6/F7	G4+M6/F7	G4+M6/F7	G4+M6/F7
Impulsion filter (SUP)	F8/F9	F8/F9	F8/F9	F8/F9	F8/F9
Extraction filter (ETA)	M6	M6	M6	M6	M6
Free cooling function by means of a motorised by-pass	YES	YES	YES	YES	YES
Panel thickness	50 mm	50 mm	50 mm	50 mm	50 mm
Condensate exhaust	YES	YES	YES	YES	YES
Built-in pressure switches for filter condition control	YES	YES	YES	YES	YES
Safety and maintenance switch	YES	YES	YES	YES	YES
Built-in control panel	YES	YES	YES	YES	YES

Technical characteristics

Model	Nominal flow rate (m ³ /h)	Recovery unit efficiency (%)	Available pressure (Pa)	Nominal power (kW)	Nominal current (A)	Voltage 50/60 Hz (V)	Irradiated sound level at 5 m dB (A)	Approx. weight (Kg)	According ErP
RECUP/EC-1200-H	1200	90	200	0.45	1.78	1/230	37	210	2018
RECUP/EC-1600-H	1600	88.8	200	0.63	2.54	1/230	40	210	2018
RECUP/EC-2100-H	2100	88.8	200	0.82	1.48	3+N/400	43	281	2018
RECUP/EC-2700-H	2700	87.8	200	1.11	1.88	3+N/400	46	281	2018
RECUP/EC-3300-H	3300	88.8	300	1.68	2.65	3+N/400	50	324	2018
RECUP/EC-4500-H	4500	88.6	300	2.53	4.34	3+N/400	57	342	2018
RECUP/EC-6000-H	6000	89.1	300	2.55	4.26	3+N/400	47	385	2018
RECUP/EC-8000-H	8000	88	300	4.04	6.41	3+N/400	51	385	2018
RECUP/EC-10000-H	10000	87	300	6.11	9.38	3+N/400	56	385	2018



Erp. (Energy Related Products)

Information on Directive 2009/125/EC can be downloaded from the SODECA website or the QuickFan selector programme.

Accessories



FILTROS



SI-PRESOSTATO



SI-CO2 IND



CG

Dimensions mm

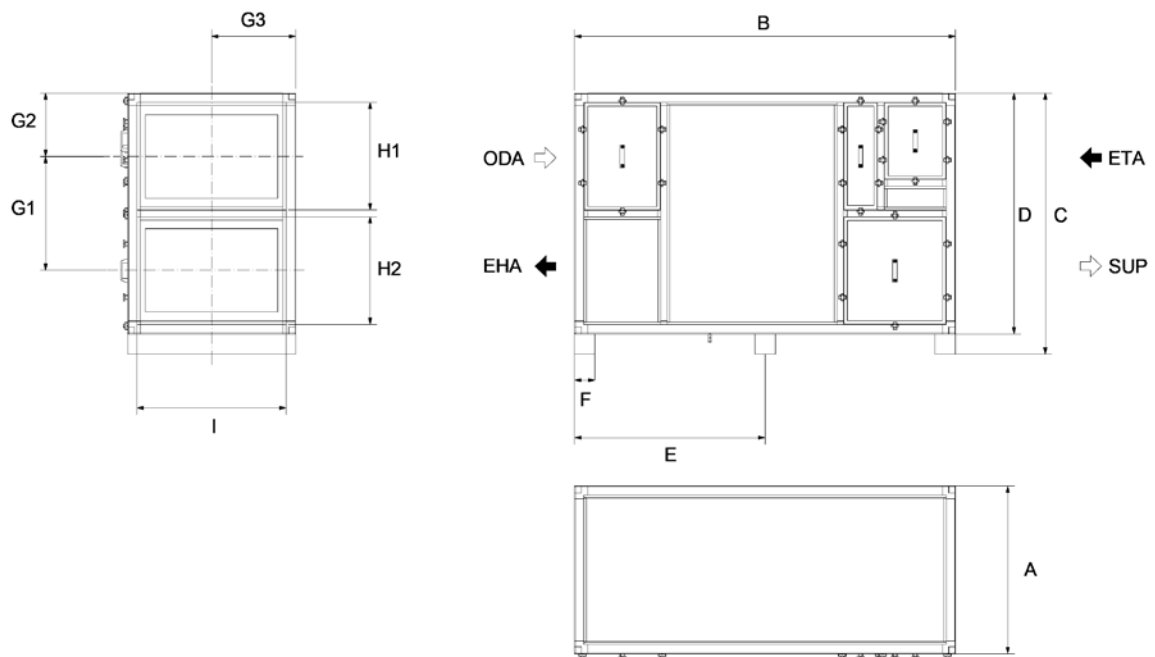

	A	B	C	D	E	F	G1	G2	G3	H1	H2	I
RECUP/EC-1200-H	566	2213	1507	1387	1030	120	672	355	283	637	647	492
RECUP/EC-1600-H	566	2213	1507	1387	1030	120	672	355	283	637	647	492
RECUP/EC-2100-H	669	2213	1507	1387	1030	120	672	355	335	637	647	595
RECUP/EC-2700-H	669	2213	1507	1387	1030	120	672	355	335	637	647	595
RECUP/EC-3300-H	992	2250	1544	1424	1048	120	677	374	496	637	637	881
RECUP/EC-4500-H	1297	2250	1544	1424	1048	120	677	374	649	637	637	1186
RECUP/EC-6000-H	1889	2250	1544	1424	1048	120	677	374	945	637	637	1778
RECUP/EC-8000-H	1889	2250	1544	1424	1048	120	677	374	945	637	637	1778
RECUP/EC-10000-H	1889	2250	1544	1424	1048	120	677	374	945	637	637	1778

ODA: Fresh outdoor air / SUP: Air impulsion to the premise / EHA: Exit of exhaust air / ETA: Air extraction from premises

Characteristic curves

Q= Flow rate in m³/h, m³/s and cfm

Pe= Static pressure in mm H₂O, Pa and inwg

RECUP/EC-1200-H

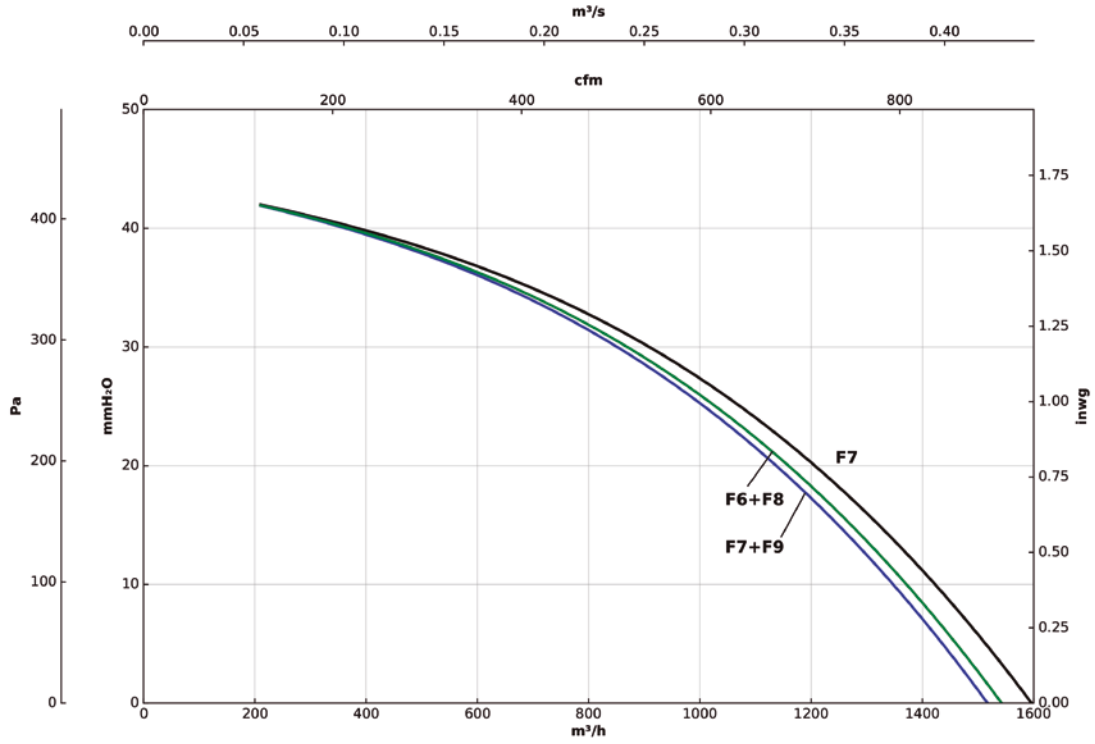

RECUP/EC-1600-H

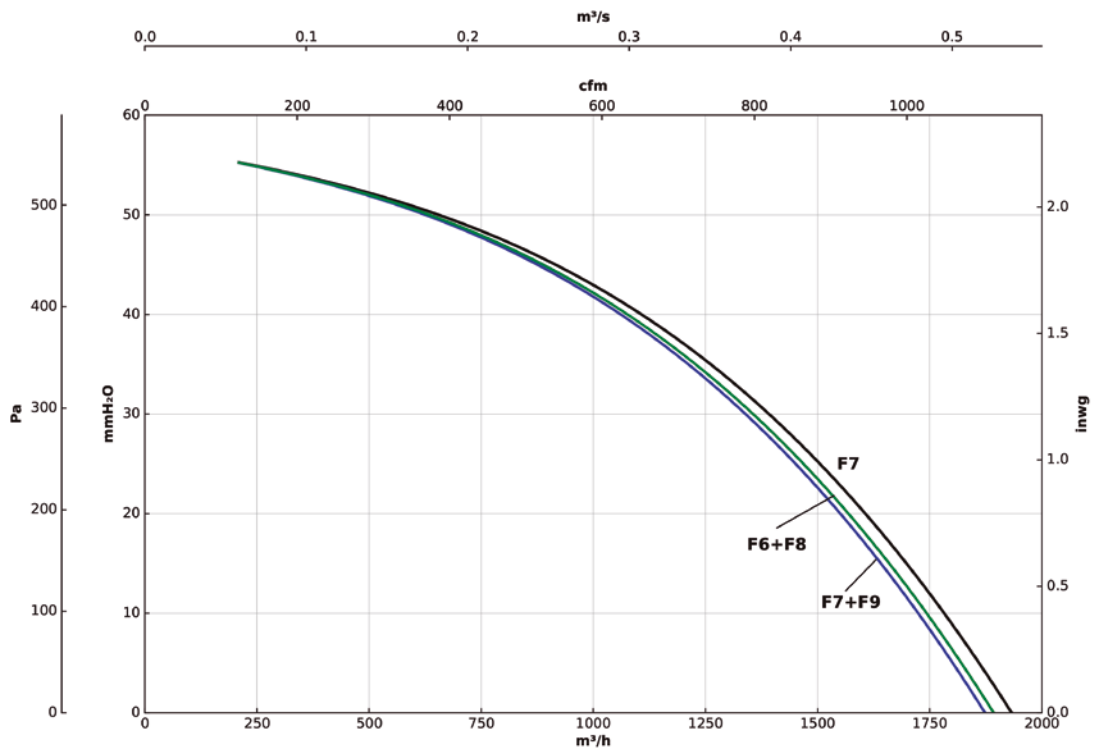

Characteristic curves

Q= Flow rate in m³/h, m³/s and cfm

Pe= Static pressure in mm H₂O, Pa and inwg

RECUP/EC-2100-H

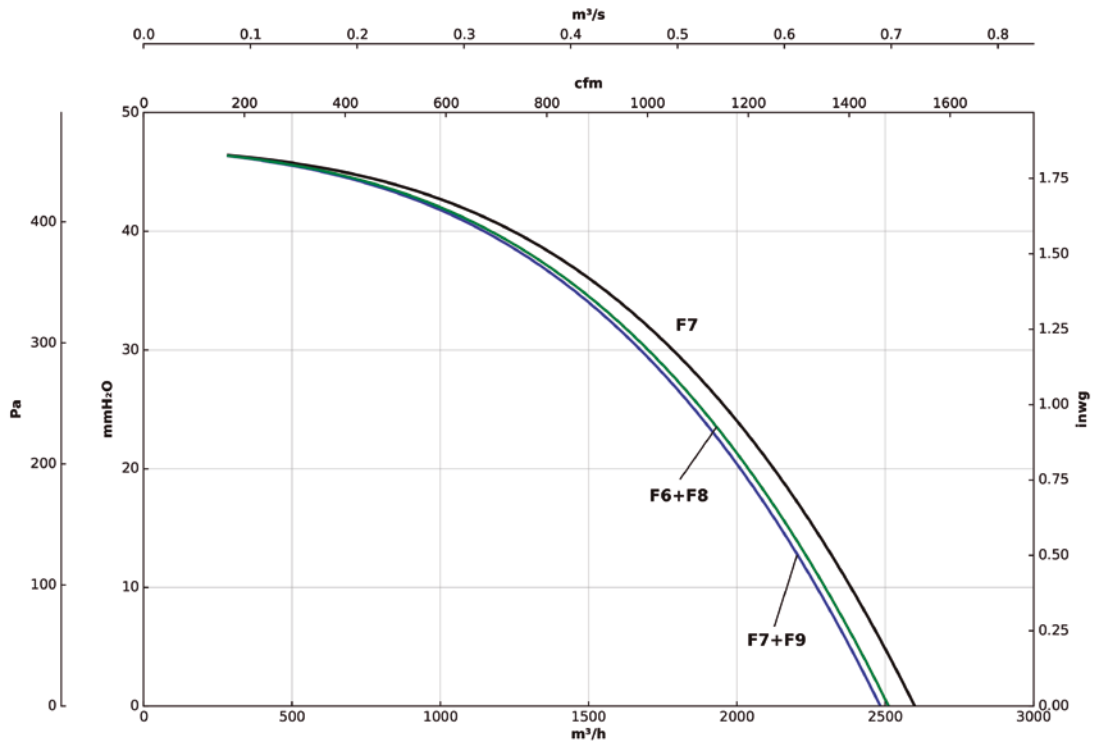

RECUP/EC-2700-H

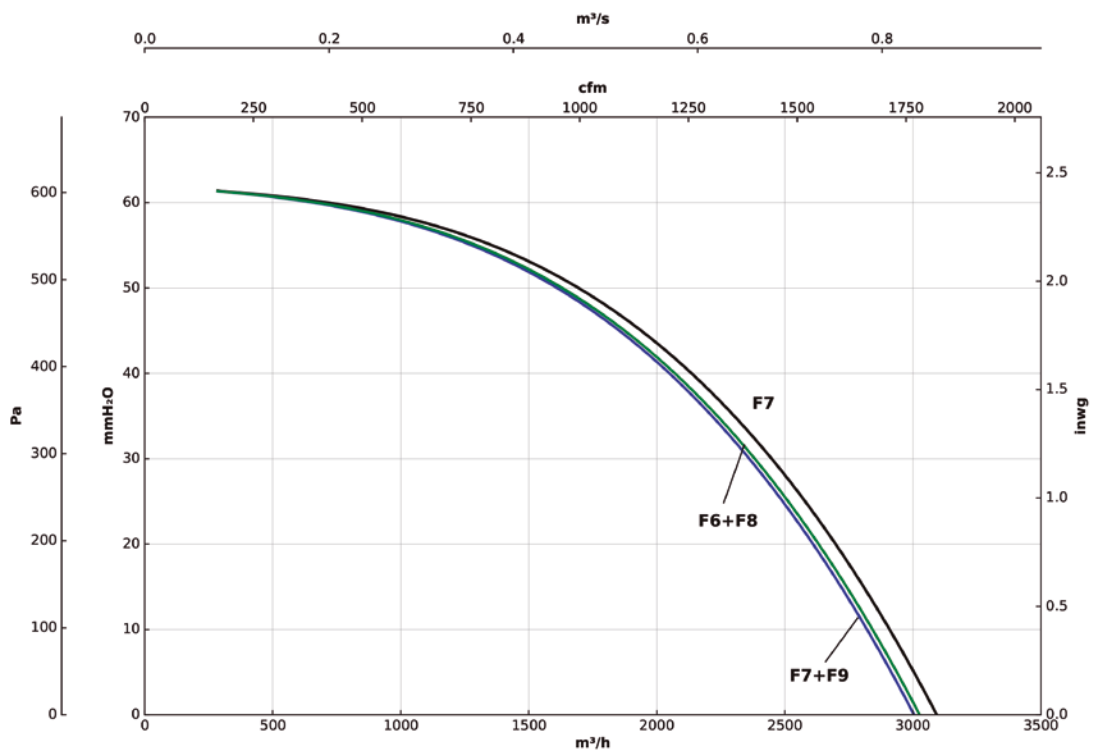

Characteristic curves

Q= Flow rate in m³/h, m³/s and cfm

Pe= Static pressure in mm H₂O, Pa and inwg

RECUP/EC-3300-H

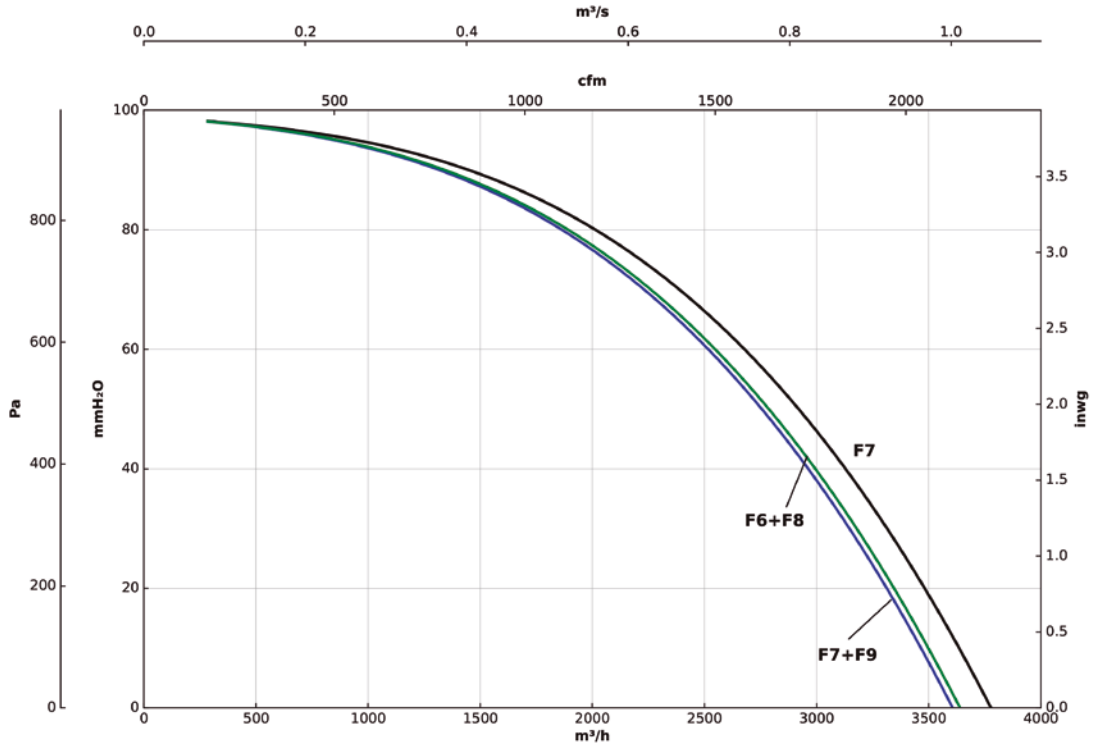

RECUP/EC-4500-H

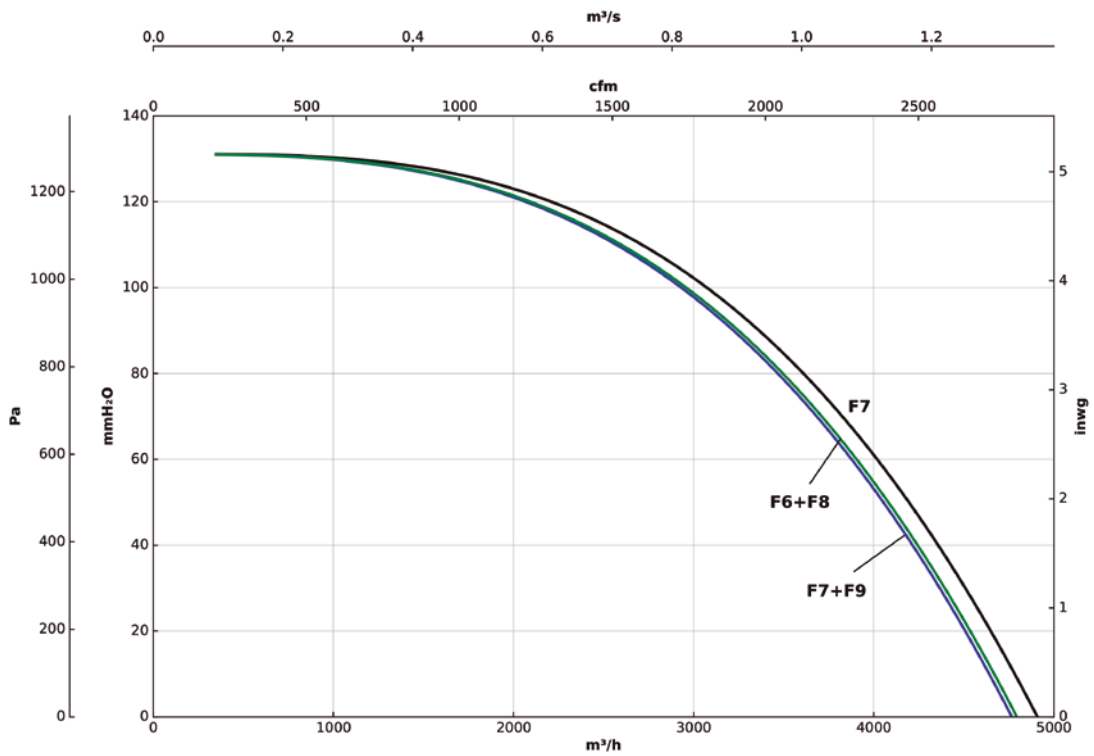

Characteristic curves

Q= Flow rate in m³/h, m³/s and cfm

Pe= Static pressure in mm H₂O, Pa and inwg

RECUP/EC-6000-H

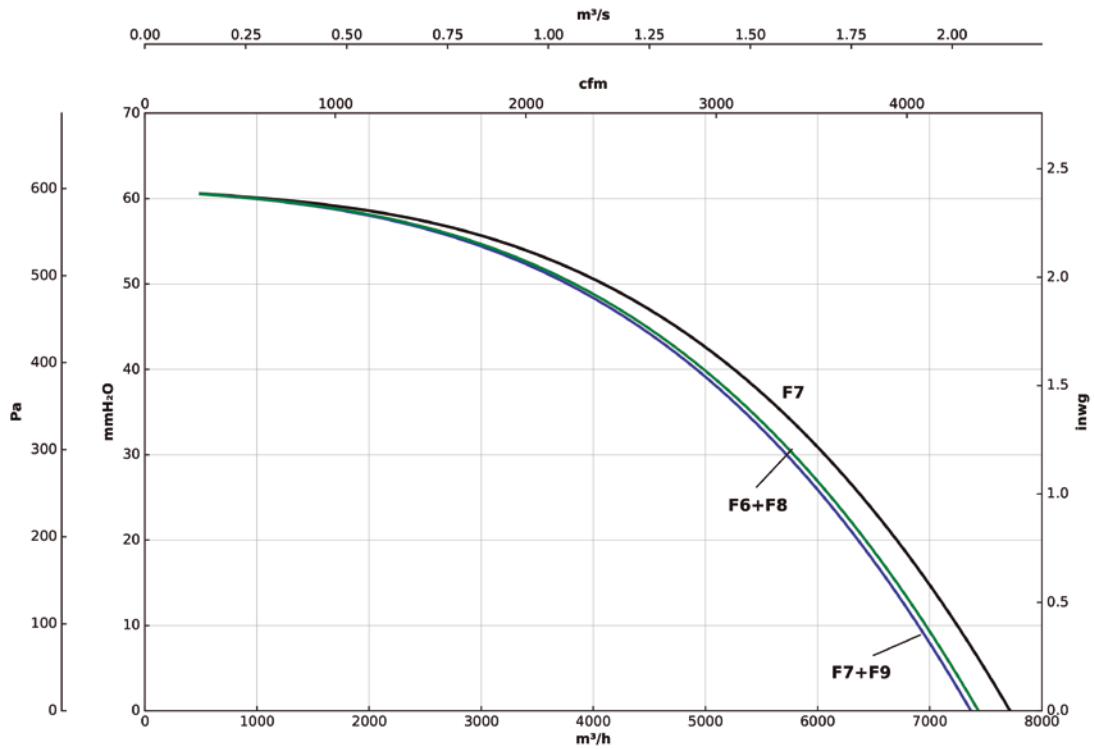

RECUP/EC-8000-H

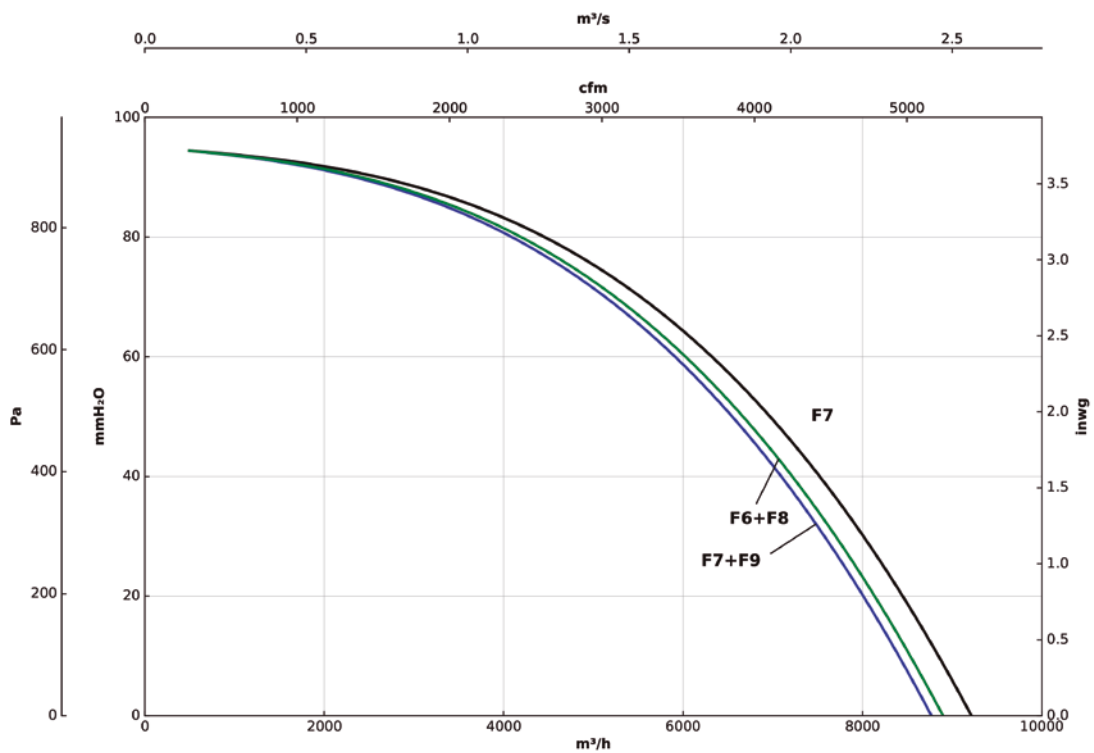

Characteristic curves

Q= Flow rate in m³/h, m³/s and cfm

Pe= Static pressure in mm H₂O, Pa and inwg

RECUP/EC-10000-H

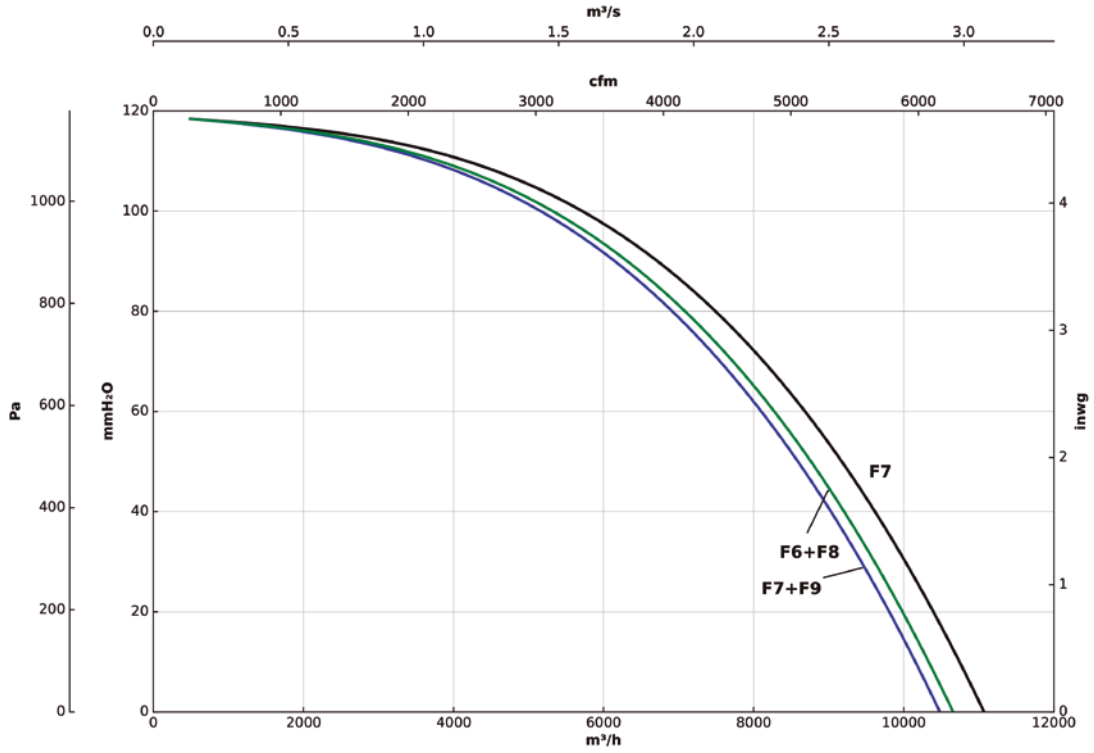

Efficiency curves

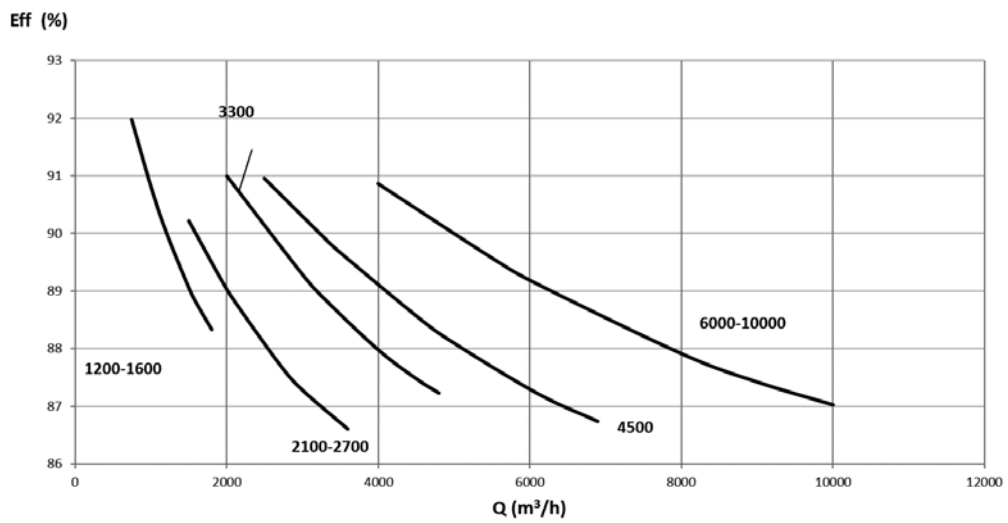

MONITORING AND CONTROL

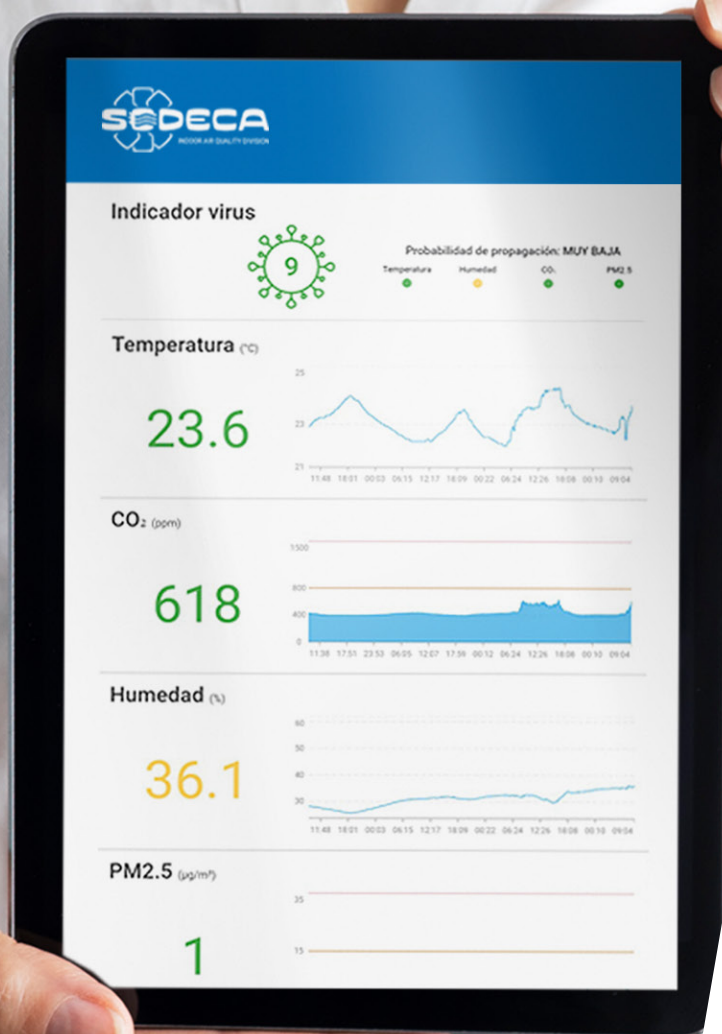

MICA-LITE/W

Air quality monitor to ensure correct ventilation in enclosed spaces



Air quality monitor with real time cloud monitoring and air status and ventilation recommendation indicator lamp.

Monitoring:

- Temperature.
- Humidity.
- Suspended particulate matter PM2.5
- CO2.

My Inbiot platform:

- Free and unlimited service.
- Simple and intuitive interface.
- Online access from any device.
- Online storage and data download.
- Personalised information and improvement recommendations.

Installation and maintenance:

- Self-installable equipment.

- Easy installation and set-up guide.
- Remote assistance.
- Maintenance free, self-calibrating sensors.
- Wall-mounted.

Data displayed on screen:

- Viral transmission probability indicator lamp.
- Data displayed on information screens for public spaces.
- Option of integration on the platform via a public API.

On request:

- Desktop equipment MICA-LITE/T.

Technical characteristics

Model	Supply voltage	Operating temperature	Approx. weight	Protection class
	(V)	(°C)	(Kg)	
MICA-LITE/W	230 V AC 50/60 Hz	-10 a +50	0.15	IP40

Dimensions mm

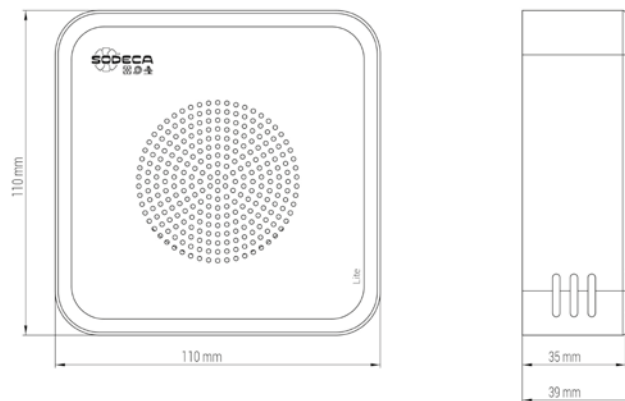

CAP/EC

Intelligent control for the regulation of equipment with EC Technology fans prepared for external air quality probes



Intelligent control designed for automatic or manual operation of EC Technology fans.

Characteristics of the main unit:

- LCD display with LED Backlight.
- Manual set point regulation 0-10 V.
- Automatic regulation 0-10 V set point according to probe reading.
- Built-in temperature and humidity sensors.
- Remote safety stop.
- Disinfection system ON/OFF.
- Filter maintenance alarm.
- Disinfection system maintenance alarm.
- Time programming.
- Modbus RTU communications channel.
- Mounted on the wall or on the fan itself.
- Power supply 230 V 50 Hz.
- Inputs:

- 2 analogue inputs 0-10 V for PM2.5 sensors, VOC or CO2.
- 1 input for filter status pressure switch voltage-free contact.
- 1 input for remote stop voltage-free contact.
- Outputs:
- 1 output 0-10 V regulation of EC Technology motor.
- 1 disinfection system actuation voltage-free contact.

Intelligent sensors:

- LED air status indicator.
- Wall-mounted.
- Power supply 230 V 50 Hz.
- Available options:
- PM2.5+VOC: For air recirculating installations.
- CO2+VOC: For air renewal installations.

Technical characteristics

Model	Regulation type				
	Temperature	Relative Humidity	PM2.5	CO ₂	VOC
CAP/EC	OK	OK	-	-	-
CAP/EC con PM2.5+VOC	OK	OK	OK	-	OK
CAP/EC con CO ₂ +VOC	OK	OK	-	OK	OK

Dimensions mm

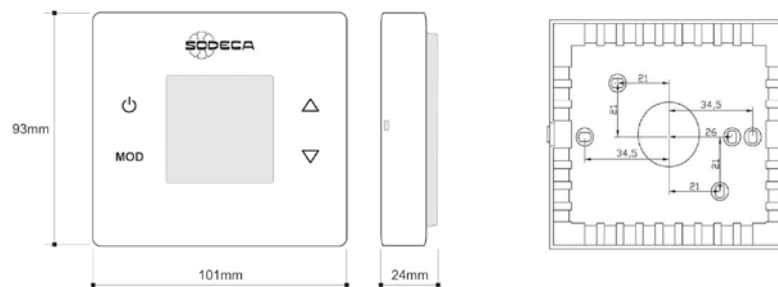

SI-PM2.5+VOC

Intelligent probe for CAP/EC control, for the regulation of ventilation based on the parameters of solid particles and volatile organic compounds

Dimensions mm

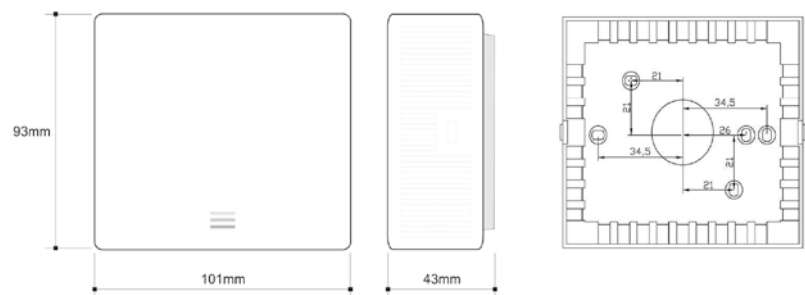

SI-CO2+VOC

Intelligent probe for CAP/EC control, for the regulation of ventilation based on CO2 and volatile organic compounds parameters

Dimensions mm

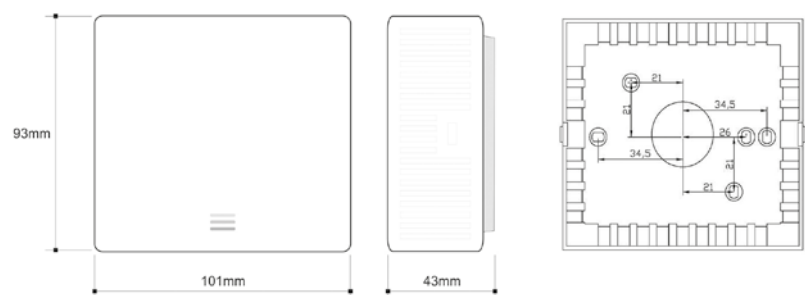

ACCESSORIES



INT

On/Off safety switches in accordance with Standard UNE-EN 60204-1

Characteristics:

- Switches to be installed next to the fan to be able to cut off the power before handling the fan.
- IP65 protection.
- Single-phase or three-phase fans, use a 3-pole switch (3CA).
- Three-phase two-speed fans, use a 6 pole switch (6CA).

Model	Current (A)	kW	Cable entry (mm)
INT-KG 20/3CA	25	7.5	29
INT-KG 41/3CA	40	15	37.5
INT-KG 64/3CA	63	22	37.5
INT-KG 80/3CA	80	30	37.5
INT-KG 100/3CA	100	37	37.5
INT-KG 20/6CA	25	7.5	29
INT-KG 41/6CA	40	15	37.5
INT-KG 64/6CA	63	22	37.5
INT-KG 80/6CA	80	30	37.5
INT-KG 100/6CA	100	37	37.5



C2V

Switch for two speed motors

Characteristics:

- 3 position 1-0-2 switch for driving 2 speed motors with Dahlander connection.
- IP67 protection.

Model	Current (A)	kW	Cable entry (mm)
C2V-CG10 A441	20	5.5	20

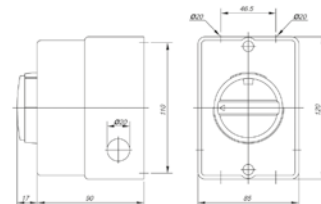

RM

Electronic speed controllers for single-phase motors

The RM models are voltage regulated. The RM/VSD1 models are frequency regulated.

Common features:

- Converters for speed variation for fans with asynchronous single-phase motors.
- Speed drive power supply single-phase 230 V 50/60 Hz.
- Start/Stop switch.
- Speed adjustment by analog command.
- According to the Electromagnetic Compatibility Directives 2014/30 / EU and Low Voltage 2014/35 / EU.

RM models features:

- Minimum speed adjustment.
- With EMC filters in accordance with Standard EN-55014.

RM/VSD1 model features:

- 16AF protective fuse.
- Dual passive (radiator) and active (cooling fan) heat dissipation system.

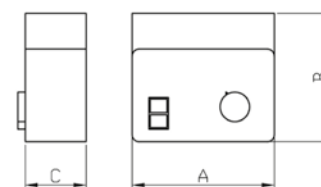

Model	A	B	C
RM-00	81	81	66
RM-01	81	81	66
RM-02	81	81	66
RM-1	80	145	80
RM-2	96	164	85
RM-3	96	164	85
RM/VSD1-3.5	200	180	100
RM/VSD1-8.0	200	225	100

Model	Regulation type	Input voltage	Output voltage	Protection	Maximum current (A)
RM-00	Voltage	230 V-50/60Hz	230 V-50/60Hz	IP-44	0.5
RM-01	Voltage	230 V-50/60Hz	230 V-50/60Hz	IP-44	1
RM-02	Voltage	230 V-50/60Hz	230 V-50/60Hz	IP-44	2
RM-1	Voltage	230 V-50/60Hz	230 V-50/60Hz	IP-54	3
RM-2	Voltage	230 V-50/60Hz	230 V-50/60Hz	IP-54	5
RM-3	Voltage	230 V-50/60Hz	230 V-50/60Hz	IP-54	10
RM/VSD1-3.5	Frequency	230 V-50/60Hz	230 V-35..50Hz	IP-20	3.5
RM/VSD1-8.0	Frequency	230 V-50/60Hz	230 V-35..50Hz	IP-20	8

ACCESSORIES



VSD3/A-RFT - VSD1/A-RFM

Electronic variable speed drive for AC motors

Characteristics:

- Converters for speed and frequency variation of axial and centrifugal fans with asynchronous three-phase motors.
- Converter power supply:
 - Single-phase (VSD1/A-RFM): 200-240 V 50/60 Hz.
 - Three-phase (VSD3/A-RFT): 380-480 V 50/60 Hz.
- In accordance with the Electromagnetic Compatibility Directive 2014/30/EU, the Low Voltage Directive 2014/35/EU and the Machinery Safety Directive 2006/42/EC.
- Stop/start input to disable/enable the drive.
- 0-10 V input for speed control.
- ModBus RTU bus connection available.
- Standard model with degree of protection IP20. Also available in IP66 version up to 10 CV. For powers greater than 15 CV, only available with protection degree IP55.
- According to norms:
 - UNE EN 61800-3: variable speed electric power drives. EMC related product standard including specific test methods.
 - UNE EN 61800-5-1: variable speed electric power drives. Security requirements. Electrical, thermal and energy.
 - UNE EN 60204-1: safety of machines. Electrical equipment of machines. General requirements.

- UNE EN 55011: limits and methods for measuring the characteristics related to radio electric disturbances of industrial, scientific and medical devices (ICM) that produce radio frequency energy.
- IEC 60529: specifications for degrees of protection in enclose premises.

In general, all SODECA fans with three-phase motors are adequate for operating supplied with a static frequency converter in normal execution (based on IEC 60034-17). However some motors require special measures. The maximum operating frequency or speed must never exceed that of the fan design. In applications with a quadratic torque such as fans and pumps, when the speed changes, the absorbed power is directly proportional to the rotation speed cube: $Pa2 = Pa1 (n2 / n1)^3$.

The insulation of the motors coupled to the fans is sufficient to work without restrictions with the frequency converter up to voltages of 500V. The use of sinusoidal filters at the converter output will contribute to the correct operation of the motor, reducing failures and increasing its useful life. It is advisable that for motors greater than 225 size, these are requested with special windings for operating with a frequency converter.

The length of the output cable from the converter to the fan has an important effect on the voltage characteristics in the motor terminals. The definition 'long cables' will depend on the nominal value and type of converter, and the technical document of the manufacturer must be consulted.

Ex-d explosion-proof motors must be requested for activation with a frequency converter. The motor manufacturer should request information on the application using a questionnaire, to define the working parameters. Furthermore, these motors must have built-in TPC sensors.

Ex-e increased safety motors cannot be activated with a frequency converter (this would require the joint motor-converter certification).

VSD1/A-RFM		VSD1/A-RFM-0,5	VSD1/A-RFM-1	VSD1/A-RFM-2	VSD1/A-RFM-3
Power	(HP)	0.50	1.00	2.00	3.00
Power	(kW)	0.37	0.75	1.50	2.20
Maximum current	(A)	2.3	4.3	7.0	10.5
Inlet					
Inlet type		Single-phase	Single-phase	Single-phase	Single-phase
Voltage	(V)	200-240 V	200-240 V	200-240 V	200-240 V
Frequency	(Hz)	50-60 Hz	50-60 Hz	50-60 Hz	50-60 Hz
Outlet					
Outlet type		Three-phase	Three-phase	Three-phase	Three-phase
Voltage	(V)	200-240 V	200-240 V	200-240 V	200-240 V
Frequency	(Hz)	0-500 Hz	0-500 Hz	0-500 Hz	0-500 Hz
Degrees of protection		Standard: IP20. On request: IP66			
Cooling		IP20: Forced. IP66: Natural			

VSD3/A-RFT		VSD3/A-RFT-1	VSD3/A-RFT-2	VSD3/A-RFT-3	VSD3/A-RFT-5.5	VSD3/A-RFT-7.5	VSD3/A-RFT-10	VSD3/A-RFT-15	VSD3/A-RFT-20	VSD3/A-RFT-25	VSD3/A-RFT-30
Power	(HP)	1.00	2.00	3.00	5.50	7.50	10.00	15.00	20.00	25.00	30.00
Power	(kW)	0.75	1.50	2.20	4.00	5.50	7.50	11.00	15.00	18.50	22.00
Maximum current	(A)	2.2	4.1	5.8	9.5	14.0	18.0	24.0	30.0	39.0	46.0
Inlet											
Inlet type		Three-phase	Three-phase	Three-phase	Three-phase	Three-phase	Three-phase	Three-phase	Three-phase	Three-phase	Three-phase
Voltage	(V)	380-480 V	380-480 V	380-480 V	380-480 V	380-480 V	380-480 V	380-480 V	380-480 V	380-480 V	380-480 V
Frequency	(Hz)	50-60 Hz	50-60 Hz	50-60 Hz	50-60 Hz	50-60 Hz	50-60 Hz	50-60 Hz	50-60 Hz	50-60 Hz	50-60 Hz
Outlet											
Outlet type		Three-phase	Three-phase	Three-phase	Three-phase	Three-phase	Three-phase	Three-phase	Three-phase	Three-phase	Three-phase
Voltage	(V)	380-480 V	380-480 V	380-480 V	380-480 V	380-480 V	380-480 V	380-480 V	380-480 V	380-480 V	380-480 V
Frequency	(Hz)	0-500 Hz	0-500 Hz	0-500 Hz	0-500 Hz	0-500 Hz	0-500 Hz	0-500 Hz	0-500 Hz	0-500 Hz	0-500 Hz
Degrees of protection		Standard: IP20. On request: IP66						IP20	IP20	IP20	IP20
Cooling		IP20 e IP55: Forced. IP66: Natural									

ACCESSORIES



AET

Electrical panel for STAR/DELTA starting and protection of three-phase fans, with stop and start buttons

Characteristics:

- Stop and start by button.
- Status display through pilot lights.
- With adjustable thermal relay for motor protection.
- Fully wired.
- Metal box for surface mounting, IP65 protection.
- The regulation current of the thermal relay must be 50 % of the rated current shown on motor plate.

**For fan with three-phase motor 400V/690V
Power supply 3x400V+N**

Model	Thermal relay adjustment current (A)	Motor power 3x400/690V (kW)
AET-01-5.5/400	4-6.3	4
AET-01-7.5/400	5-8	5.5
AET-01-10/400	7-10	7.5
AET-01-15/400	12-18	11
AET-01-20/400	12-18	15

Model	Thermal relay adjustment current (A)	Motor power 3x400/690V (kW)
AET-01-30/400	18-26	18.5/22.0
AET-01-40/400	28-40	30
AET-02-50/400	34-50	37
AET-02-60/400	45-65	45
AET-02-75/400	45-65	55



PT

Automatic closing shutters to work in vertical position

Characteristics:

- Circular self-closing shutters to be installed in the suction of roof extractors.
- Use of PA adaptor plate recommended for assembly.



ACE ACE/400

Elastic coupling to dampen vibrations

Characteristics:

- It is used between the fan mouth and the duct to avoid the transmission of vibrations.
- It is advisable to add the B accessory at the inlet and BIC at the outlet, except in CPV models.



VIS

Outlet hood with protection guard

Characteristics:

- Prevents objects and water from entering the fan.



TAC

Circular coupling cap

Characteristics:

- To convert the rectangular inlet or outlet of the CJBD/CJBX models to circular.



TEJ

Roof cover for outdoor

Characteristics:

- Avoids water entering ventilation units installed outside.



SB

Anti-vibrations shock absorbers

Spring shock absorbers to prevent the transmission of vibrations.



BS

Support bench

ACCESSORIES

SI-CO2 IND



CO2 concentration sensor

Model	Power supply	Outlet	Maximum consumption (VA)	CO ₂ concentration range CO ₂	Operating temperature
SI-CO2 IND/P	15-24V ac ±10 %/18-34V dc	0-10V dc/0-20mA	2.5	0-2000 ppm	-10 +50 °C
SI-CO2 IND/C	15-24V ac ±10 %/18-34V dc	0-10V dc/0-20mA	2.5	0-2000 ppm	0 +50 °C

SI-MF



Multifunctional sensor that controls temperature, relative humidity and CO₂

Model	Power supply	Outlet	Maximum consumption (VA)	Relative humidity range	CO ₂ concentration range CO ₂	Operating temperature
SI_MF	24 VAC / VDC ± 10 % (0–10 VDC / 0–20 mA)		3.3	0-100 % RH	0-2000 ppm	0 +50 °C

SI-PRESIÓN



Pressure transmitter

Monitors the pressure in ventilation installations at constant pressure, and transforms it into an electrical signal, to regulate the ventilation system and always maintain the same pressure.

Model	Power supply	Outlet	Maximum consumption (VA)	Connectors	Pressure range
SI-PRESIÓN TPDA	24V ac/24V dc	0-10V/4-20mA	4	6.2 mm	0-2500 Pa
SI-PRESIÓN TPDA c/DISPLAY	24V ac/24V dc	0-10V/4-20mA	4	6.2 mm	0-2500 Pa

SI-VOC+HUMEDAD



Air quality, humidity and temperature sensor for controlling 3 speed motors

Model	Power supply	Outlet	Maximum consumption (VA)	Relative humidity range	CO ₂ concentration range VOC	Operating temperature
SI-VOC+HUMEDAD	230 V ac	230 V ac (V1, V2, V3)	2	5%RH - 95% RH	0-999 ppm	-10 +50 °C

MTP



Brushless motor speed control 0-10 V

Characteristics:

- Potentiometer for speed control of fans equipped with 0-10 VDC brushless motor.
- Gradually delivers a voltage of between 0 and 10 VDC.
- Can be used as a switch.
- Moisture resistant body.
- Possibility of surface or recessed mounting.



CJFILTER

Air filter boxes, for circular ducts, equipped with different types of filters, depending on the model

Characteristics:

- Galvanised sheet casing.
- Standard circular clamps in inlet and outlet, with airtight joints to help in duct installation.
- Inspection and filter change cover, easy to open.
- G4, F5, F6, F7, F8 and F9 filters, according to model.

ACCESSORIES



CG

Germicidal chamber

Built on the basis of UVC ultraviolet lamps in a 256 nm spectrum, a wave width indicated to inactivate a wide variety of microorganisms by absorbing short wavelength energy through DNA and RNA.



SI-PRESOSTATO

Pressure sensor

Monitors the pressure difference between filters, once it reaches the selected value it triggers a contact to activate an alarm relay.



KIT CAUDAL CONSTANTE

Set consisting of a pressure transmitter and a frequency converter, designed to increase the fan speed as the filter becomes dirty, and to maintain a constant flow in the installation



SONDA PRESIÓN DIFERENCIAL

Monitors the pressure difference between filters, to detect when filters are dirty and need to be replaced



HEADQUARTER

Sodeca, S.L.U.
Pol. Ind. La Barricona
Carrer del Metall, 2
E-17500 Ripoll
Girona, SPAIN
Tel. +34 93 852 91 11
Fax: +34 93 852 90 42
General sales:
comercial@sodeca.com
Export sales:
ventilation@sodeca.com

PRODUCTION PLANT

Sodeca, S.L.U.
Ctra. de Berga, km 0,7
E-08580 Sant Quirze de
Besora
Barcelona, SPAIN
Tel. +34 93 852 91 11
Fax: +34 93 852 90 42
General sales:
comercial@sodeca.com
Export sales:
ventilation@sodeca.com



EUROPE

FINLAND

Sodeca Finland, Oy
HUITTINEN
Sales and Warehouse
Mr. Kai Yli-Sipilä
Metsälinnankatu 26
FI-32700 Huitinen
Tel. + 358 400 320 125
orders.finland@sodeca.com

HELSINKI
Smoke Control Solutions
Mr. Antti Kontkanen
Viilpulantie 9C
FI-00700 Helsinki
Tel. +358 400 237 434
akontkanen@sodeca.com

HYVINKÄÄ
Industrial Applications
Mr. Jaakko Tomperi
Niinistökatu 12
FI-05800 Hyvinkää
Tel. +358 451 651 333
jtomperi@sodeca.com

ITALIA

Marelli Ventilazione, S.R.L.
Viale del Lavoro, 28
37036 San Martino B.A.
(VR), ITALY
Tel. +39 045 87 80 140
vendite@sodeca.com

PORTUGAL

Sodeca Portugal, Unip. Lda.
PORTO
Rua Veloso Salgado 1120/1138
4450-801 Leça de Palmeira
Tel. +351 229 991 100
geral@sodeca.pt

LISBOA
Pq. Emp. da Granja Pav. 29
2625-607 Vialonga
Tel. +351 219 748 491
geral@sodeca.pt

ALGARVE
Rua da Alegria, 33
8200-569 Ferreiras
Tel. +351 289 092 586
geral@sodeca.pt

UNITED KINGDOM

Sodeca Fans UK, Ltd.
Mr. Mark Newcombe
Tamworth Enterprise Centre
Philip Dix House, Corporation
Street, Tamworth, B79 7DN
UNITED KINGDOM
Tel. +44 (0) 1827 216 109
sales@sodeca.co.uk

AMERICA

CHILE

Sodeca Ventiladores, SpA.
Sra. Sofía Ormazábal
Santa Bernardita 12.005
(Esquina con Puerta Sur)
Bodegas 24 a 26,
San Bernardo, Santiago, CHILE
Tel. +56 22 840 5582
ventas.chile@sodeca.com

COLOMBIA

Sodeca Latam, S.A.S.
Sra. Luisa Stella Prieto
Calle7 No. 13 A-44
Manzana 4 Lote1, Montaña
Mosquera, Cundinamarca
Bogotá, COLOMBIA
Tel. +57 1 756 4213
ventascolombia@sodeca.co

PERU

Sodeca Perú, S.A.C.
Sr. Jose Luis Jiménez
C/ Mariscal Jose Luis de
Orbegoso 331. Urb. El pino.
15022, San Luis. Lima, PERÚ
Tel. +51 1 326 24 24
Cel. +51 994671594
comercial@sodeca.pe



HEADQUARTER

Sodeca, S.L.U.
 Pol. Ind. La Barricona
 Carrer del Metall, 2
 E-17500 Ripoll
 Girona, SPAIN
 Tel. +34 93 852 91 11
 Fax: +34 93 852 90 42
 General sales: comercial@sodeca.com
 Export sales: ventilation@sodeca.com

PRODUCTION PLANT

Sodeca, S.L.U.
 Ctra. de Berga, km 0,7
 E-08580 Sant Quirze de Besora
 Barcelona, SPAIN
 Tel. +34 93 852 91 11
 Fax: +34 93 852 90 42
 General sales: comercial@sodeca.com
 Export sales: ventilation@sodeca.com



www.sodeca.com

